

ComColor GL Series

9730/9730R
7430/7430R

This guide describes total operation features
and specifications.

User's Guide

ComColor GL Series

Model: 68A01/68A03

This Product Contains RFID (Radio Frequency Identification) System

Model: 050-34901

Contains FCC ID: RPARFR6

This device complies with Part 15 of the FCC Rules. Operation is subject to the following two conditions: (1) this device may not cause harmful interference, and (2) this device must accept any interference received, including interference that may cause undesired operation.

The user is cautioned that unauthorized changes or modifications not approved by RISO could void the user's authority to operate the equipment.

NOTE: This equipment has been tested and found to comply with the limits for a Class B digital device, pursuant to part 15 of the FCC Rules. These limits are designed to provide reasonable protection against harmful interference in a residential installation. This equipment generates, uses and can radiate radio frequency energy and, if not installed and used in accordance with the instructions, may cause harmful interference to radio communications. However, there is no guarantee that interference will not occur in a particular installation. If this equipment does cause harmful interference to radio or television reception, which can be determined by turning the equipment off and on, the user is encouraged to try to correct the interference by one or more of the following measures:

- Reorient or relocate the receiving antenna.
- Increase the separation between the equipment and receiver.
- Connect the equipment into an outlet on a circuit different from that to which the receiver is connected.
- Consult the dealer or an experienced radio / TV technician for help.

Contains IC: 4819A-RFR6

Operation is subject to the following two conditions: (1) this device may not cause interference, and (2) this device must accept any interference, including interference that may cause undesired operation of the device.

CAN ICES-3(B)/NMB-3(B)

Perchlorate Material-special handling may apply,

See www.dtsc.ca.gov/hazardouswaste/perchlorate

This product may contain certain substances which are restricted when disposed. Therefore, be sure to consult your contracted service dealer.



RE directive Class1 device



CAUTION

Be sure to read this guide prior to use.

After reading this guide, keep it in handy for future reference.

About This Guide

Preface

Thank you for your purchase of a ComColor GL series product.

This ComColor GL series product is a network-compatible high-speed color printer that uses inkjet technology.

The machine comes with oil-based ink excellent in color performance. Five colors of ink, cyan, magenta, yellow, black, and gray are used to reproduce smooth expression of gradations.

Besides, the machine provides various functions such as output of data and management of the printer from a computer, copying and scanning paper originals*, post-processing (staple, punch, etc.)*, and high capacity feeding or stacking*.

* Available when the machine is in combination with the relevant type of optional equipment.

The following manuals are included with this machine.

● Quick Guide

This guide describes basic machine operations and how to replace consumables.

Keep this guide handy, such as near the machine, for easy reference.

● User's Guide (this guide)

This guide describes handling precautions and specifications, as well as the operations and settings of each function.

Read this guide for a more detailed understanding of the machine.

● Administrator's Guide

This guide describes the machine settings and optional equipment to be configured by the administrator.

● Troubleshooting Guide

This guide describes the actions to take when a paper jam or other problem occurs.

About This Guide

(1) This guide may not be reproduced in whole or in part without the permission of RISO KAGAKU CORPORATION.

(2) The contents of this manual may be changed without prior notice due to product improvements.

(3) RISO KAGAKU CORPORATION shall not be liable for any consequence of using this guide or the machine.

Trademark Credits

Microsoft, Windows, Windows Server, Internet Explorer, and Microsoft Edge are either registered trademarks or trademarks of Microsoft Corporation in the United States and/or other countries.

Mac, macOS, OS X, and Safari are trademarks of Apple Inc.

Adobe, the Adobe logo, PostScript, and PostScript 3 are either registered trademarks or trademarks of Adobe in the United States and/or other countries.

Linux® is the registered trademark of Linus Torvalds in the U.S. and other countries.

ColorSet is a trademark of Monotype Imaging Inc. registered in the U.S. Patent & Trademark Office and may be registered in certain jurisdictions.

FeliCa is a registered trademark of Sony Corporation.

MIFARE is a registered trademark of NXP B.V.

 **RISO**, ComColor and FORCEJET are trademarks or registered trademarks of RISO KAGAKU CORPORATION in the United States and other countries.

Other corporate names and/or trademarks are either registered trademarks or trademarks of each company, respectively.

Symbols, Notations, and Screenshots Used in This Guide

■ Symbols Used in This Guide



Indicates cautions that should be noted for safe use of this machine.



Indicates important items that should be noted or are prohibited.



Indicates useful or additional information.

■ Names of Keys and Buttons

The following names are indicated with square brackets []:

- The names of hard keys on the operation panel
- The names of buttons/items on the touch panel
- The names of buttons/items on the computer window

Example: Press the [Stop] key.

■ Names of Optional Equipment

In this guide, the names of the optional equipment are described using a generic term as shown below. The specific name for each item of equipment is used when its unique features are explained.

Name Used in This Guide	Optional Equipment
Standard Tray	High capacity feeder
Stacking tray*	Auto-control stacking tray
	Wide stacking tray
	High capacity stacker

* Optional stacking tray connected to the right side of the machine.

■ Illustrations and Operating Procedures in This Guide

- The operating procedures, screenshots, and illustrations in this guide are for the ComColor GL9730/GL9730R with the optional scanner connected. This guide also assumes that each function is set to the factory setting, and that [Login Setting] is set to [ON].
- The screenshots and illustrations in this guide may vary depending on the machine model and usage environment, including the connected optional equipment.

Functions Made Possible by Installing Optional Equipment

A variety of optional equipment is available to expand the functionality of this machine. The list below shows the optional equipment that is required to expand each function. For more information, see "Optional Equipment" (p.177).

Function to Expand	Optional Equipment Required (one of the following)
Staple	Face down finisher Multifunction finisher
Punch	Multifunction finisher with the punch unit installed
Bi-fold	Multifunction finisher
Tri-fold, Z-fold	Multifunction finisher with the folder unit installed
Creating the booklets with saddle stitch stapling	Multifunction finisher
Offset output	Face down finisher High capacity stacker Multifunction finisher
Output tray selection	Auto-control stacking tray Wide stacking tray High capacity stacker Multifunction finisher
Automatic switching of output tray (output tray relay)	Auto-control stacking tray High capacity stacker Multifunction finisher
High capacity feeding	Additional tray High capacity feeder
High capacity stacking	High capacity stacker
Printing, enveloping, and sealing enveloped mail	Wrapping envelope finisher
Perfect binding	Perfect binder
Login with authentication card	IC card authentication kit IC card reader activation kit
Printing with PostScript 3 printer driver	PS kit Print controller
Printing PDF files saved on USB flash drive	PS kit
Printing from Mac OS	PS kit Print controller
Printing from tablet or smartphone using RISO PRINT-S application	PS kit

PS Kit FG10 is not supported in some regions.

What You Can Do With This Machine

Re-order pages and print

Combine (p.68, p.113), Image Repeat (p.68, p.114), Booklet (p.68, p.114)

You can combine multiple pages to be placed on a single page or print data after laying out several sets of data for a single page. You can also re-order the pages to be in the correct order when the printed sheets are folded into two.

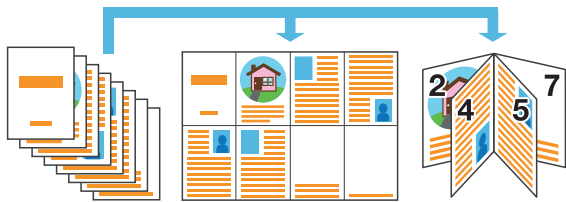
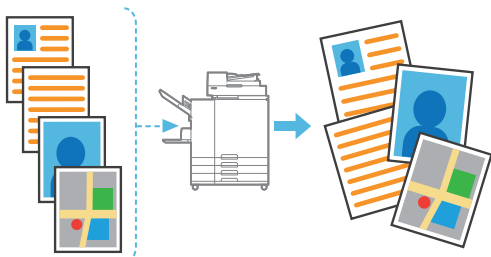

Image processing according to the original type

Original Type (p.71, p.93, p.120)

You can perform the appropriate image processing for copying, scanning, and printing according to the original types such as photos or penciled drawings.



Register and retrieve settings

Favorites (p.81, p.95, p.112, p.140, p.151)

You can register shortcuts for your favorite functions on the [Home2] screen. This will enable you to bring up your favorite settings without moving to each mode.

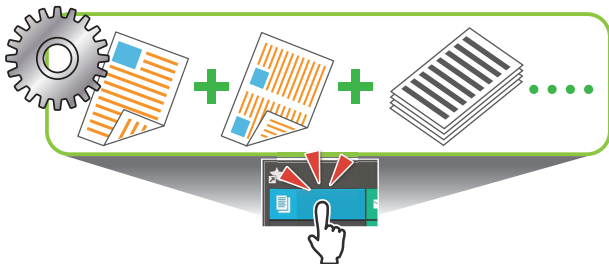

Check the results before printing large amounts

Sample Copy (p.81), Print and Pause (p.109)

You can print one sample and check the results and settings.



Collectively output multiple scanned data

Scan Job Build (p.80)

Collectively copy multiple data scanned with different settings as one job.



Enlarge and print onto multiple sheets of paper

Poster (p.115)

Enlarge one page of image data and divide it onto multiple sheets of paper for printing. You can create a large printout as a poster by sticking the printed sheets of paper together.

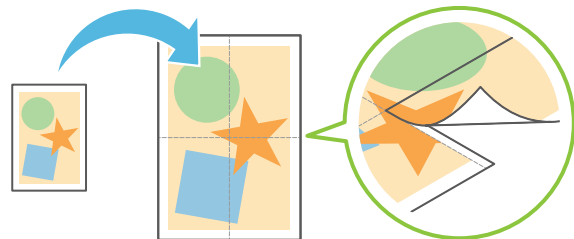

Create multiple-page forms

Multi-part Paper Printing (p.127)

You can prepare multiple-page forms consisting of multiple pages that form a single set.

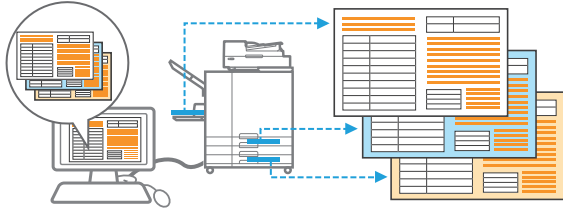

Protect documents with a PIN code

PIN Code (p.93, p.125)

You can set a PIN code for scanned documents and print jobs. This will allow only certain people to process the document or job.

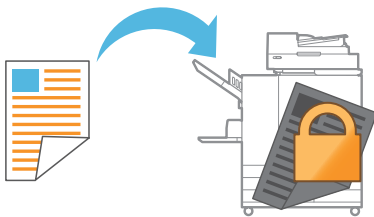

Coordinate with external servers and systems

External System Link (p.132)

It is possible to authenticate users with an external server and limit the use of this machine and also print documents that have been saved on an external system.



Compose images and text onto originals

Stamp (p.69, p.116), Overlay (p.73), Watermark (p.115)

You can print documents upon adding page numbers, dates, text, stamps, or other transparent patterns onto originals. In addition, you can also make copies upon layering an image that has been saved on the storage.

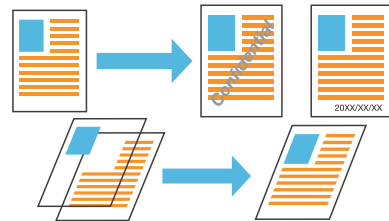

Specify the number of copies by group

Program (p.74, p.125)

Even in cases when the number of copies differ depending on where the document will be distributed, you can quickly print the number of copies of the number of sets needed without the need for settings each time by configuring such information in advance.

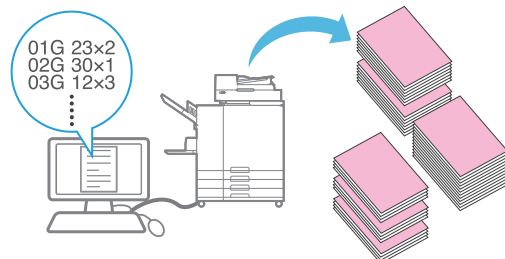

Correct color balance

Gamma Correction (p.72, p.93, p.122)

Corrects the balance of colors the original contains to bring colors closer to natural shades.

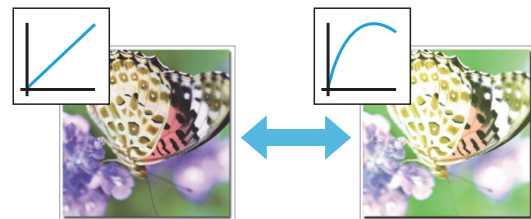

Contents

About This Guide	1
Symbols, Notations, and Screenshots Used in This Guide	2
Functions Made Possible by Installing Optional Equipment	3
What You Can Do With This Machine	4
Re-order pages and print	4
Image processing according to the original type	4
Register and retrieve settings	4
Check the results before printing large amounts	4
Collectively output multiple scanned data	4
Enlarge and print onto multiple sheets of paper	4
Create multiple-page forms	5
Protect documents with a PIN code	5
Coordinate with external servers and systems	5
Compose images and text onto originals	5
Specify the number of copies by group	5
Correct color balance	5
Safety Precautions	13
Warning Symbols	13
Power Plug	13
Installation Location	13
Power Connection	14
Ground Connection	14
Handling	14
Ink Cartridge	15
Before Use	16
Installation Location	16
Power Connection	16
Connecting to a Computer	17
Required Spacing	18
Handling	22
Originals	22
Printable Area	23
Printing Paper	24
Printouts	26
Materials Not to Be Printed	26
Ink Cartridge Storage and Handling Precautions	26
Disposing of Used Ink Cartridges and Cleaning Tanks	27
Part Names and Functions	28
Main Unit and Optional Scanner	28
Operation Panel	30
Touch Panel	32
[Home1] Screen	32

[Home2] Screen	33
Mode Screens	34
Touch Panel	42
Preparation	44
Power	44
Login	45
Loading the Paper	46
Installing and Uninstalling the Printer Driver	50
Operating Environment	50
Installing	50
Uninstalling	51
About Jobs	52
[Active / Idle] Screen	52
[Finished] Screen	53
[Paper info] Screen	53

Chapter 1 Copying	55
Overview of Copy Operations	56
Procedure	56
List of Settings	59
Copy Settings	61
Color Mode	61
Reproduction Size	61
Paper Selection	61
Scanning Size	63
Original Orientation	64
Duplex/Simplex	64
Sort	64
Scanning Level	65
Print Density	65
ADF Scan & Pause	65
Mixed Size Original	65
Book Shadow Erasure	66
Page Split	67
Combine	68
Image Repeat	68
Booklet	68
Stamp	69
Page Border	71
Image Quality	71
Original Type	71
Gamma Correction	72
Image Control	72
Base Color Level	72
Image Position	73
Overlay	73

Program	74
Add Cover	77
Separation	77
Binding Margin	78
Staple / Punch	78
Fold	79
Slow Printing	79
Output Tray	79
Face Up/Down	79
Output Tray Relay	79
Paper Tray Relay	79
Auto Image Rotation	79
Scan Job Build	80
Interrupt Copy	80
Copy Mode Function Buttons	81
Favorites	81
Additional Copy	81
Sample Copy	81
Check Setting	82
Custom Menu	82

Chapter 2 Scanning	85
Overview of Scan Operations	86
Procedure	86
List of Settings	89
Scan Settings	90
Document Name	90
Color Mode	90
Scanning Size	91
File Format	91
Duplex/Simplex	91
Scanning Level	92
Original Orientation	92
Resolution	92
Mixed Size Original	92
Page Size	92
Book Shadow Erasure	92
Page Split	93
PIN Code	93
Original Type	93
Gamma Correction	93
Image Control	93
Base Color Level	93
Reproduction Size	94
Scan Job Build	94
Scan Mode Function Buttons	95

Favorites	95
Check Setting	95
Preview before sending	95
Custom Menu	96

Chapter 3 Printing 99

Overview of Print Operations	100
Procedure From the Printer Driver	100
Procedure From Print Mode	100
Printer Driver Screen	103
List of Settings	104
Printer Driver Settings	107
Common Buttons	107
[Basic] Tab	108
[Favorites] Tab	112
[Layout] Tab	113
[Finishing] tab	118
[Image] Tab	120
[Advanced] Tab	124
[Environment] Tab	127
Print Mode Function Buttons	131
View Selection	131
Online/Offline	131
Select All	131
Details	131
Change Setting	131
External System Link	132

Chapter 4 Storage 133

Overview of Storage Operations	134
Saving the Data to a Folder	134
Printing a Document in a Folder	135
List of Settings in [Storage] - [Save]	137
List of Settings in [Storage] - [Load]	139
Storage Mode Function Buttons	140
Function Buttons in [Storage] - [Save]	140
Function Buttons in [Storage] - [Load]	141

Chapter 5 USB 145

Overview of USB Operations	146
Saving the Scanned Data to a USB Flash Drive	146
Printing a Document Saved on a USB Flash Drive	147
List of Settings in [USB] - [Save]	149
List of Settings in [USB] - [Load]	150
USB Mode Function Buttons	151

Function Buttons in [USB] - [Save]	151
Function Buttons in [USB] - [Load]	152

Chapter 6 RISO Console	155
Overview of the RISO Console	156
Top Screen	156
Starting the RISO Console	157
Common Button Operations	158
[System Info] Menu	159
[Consumables] Screen	159
[Machine Info] Screen	159
[User Info] Screen	161
[License Info] Screen	161
[Scan] Menu	162
[Scan] Menu Screen	162
[Print] Menu	163
[Print] Menu Screen	163
[Storage] Menu	164
[Load] Screen	164
[Job Status] Menu	165
[Active / Idle] Screen	165
[Finished] Screen	165
[Maintenance] Menu	166
[Maintenance] Menu Screen	166
 Chapter 7 Using the Barcode Area Definition Software	167
Overview of the Barcode Area Definition Software	168
Installing the Barcode Area Definition Software	168
Starting the Barcode Area Definition Software	169
Main Screen	169
Creating and Registering a Barcode Area Definition File	171
Procedure	171
Repetition Function	175
Printing Barcode Originals	175
 Chapter 8 Optional Equipment	177
Face Down Finisher	178
Caution Label	179
List of Settings	180
Printer Driver Settings	180
Copy Mode Settings	183
Additional Tray	185
Loading the Paper	185
High Capacity Feeder	187

Loading the Paper	188
Adding the Paper	190
Stacking Tray (Auto-control Stacking Tray / Wide Stacking Tray)	191
Loading the Stacking Tray	191
List of Settings	193
Printer Driver Settings	193
Copy Mode Settings	194
Maintenance Mode Settings	194
High Capacity Stacker	195
Setting the Corrugators	196
Removing Printouts	196
Setting the Stacking Tray on the Carriage	198
List of Settings	199
Printer Driver Settings	199
Copy Mode Settings	200
Maintenance Mode Settings	201
Multifunction Finisher	202
Caution Label	204
List of Settings	205
Printer Driver Settings	206
Copy Mode Settings	213
PS Kit	218
Operating Environment	218
Installing to Windows	218
Installing to Mac OS	219
Installing to Linux	223
How to Print	223
Printer Driver Settings	224
[Basic] Tab	224
[Favorites] Tab	225
[Layout] Tab	226
[Finishing] Tab	226
[Image] Tab	227
[Advanced] Tab	228
[Environment] Tab	232
RISO Console Settings	232
Printable Files in the USB Flash Drive	232
Font List	236
Printing From Your Tablet or Smartphone	238
Chapter 9 Appendix	239
Maintenance	240
Print Head Cleaning	240
Front Cover Release	240
Paper Guide Control	240
Glue Temperature	241



Maximum Pages per Mail	241
About Ink Cartridges	242
Ink Cartridge Replacement	242
Specifications	243
Consumables	253
Ink Cartridges	253
Index	254

Safety Precautions





This section describes the items that should be followed for safe use of this machine. Be sure to read this section before using the machine.

Warning Symbols

To use the machine properly and to prevent human injury and damage to properties, the following warning symbols are used. Read the meaning of the symbols to understand and then read this guide.

 WARNING	Indicates that incorrect handling by ignoring this symbol may cause death or serious human injury.
 CAUTION	Indicates that incorrect handling by ignoring this symbol may cause human injury or damage to properties.

Examples of symbols

	The  symbol indicates a prohibited action. A specific prohibited action is drawn inside or next to the symbol. (The left figure indicates that disassembly is prohibited.)
	The  symbol indicates a forced action or an instruction. A specific instruction is drawn inside the symbol. (The left figure indicates an instruction to remove the power plug from the electrical outlet.)

Power Plug

- If the following options are connected, you will have two or more plugs.
 - Scanner
 - Face down finisher
 - High capacity feeder
 - High capacity stacker
 - Multifunction finisher



Installation Location

CAUTION

- Place the machine on a flat or stable surface. Otherwise, the machine might be inclined or fall down, resulting in human injury.
- When installing the machine without the use of a special scanner stand, do not install the machine in a location where it will be exposed to vibration from other machines. Otherwise, the machine may drop or fall and injure someone.
- The machine has ventilation openings. Place the machine at least 100 mm (3 15/16") from walls. If the ventilation openings are blocked, the inside of the machine may become hot and a fire might occur.
- Do not place the machine in a dusty or humid location. Otherwise, a fire or an electric shock might occur.

Power Connection

WARNING

- Install the machine near the wall socket to avoid using an extension cord between the machine and the wall socket. If an extension cord is absolutely required, do not use longer than 5m (15ft). Otherwise, a fire or an electric shock might occur. 
- Do not damage or rebuild the power cord. Placing a heavy object on the cord or pulling or forcibly bending the cord may damage the cord, resulting in a fire or an electric shock. 
- The power cord supplied with this product can be used only for this machine. Do not use it for another electric product. Otherwise, a fire or an electric shock might occur.
- Do not plug or unplug the power cord if your hands are wet. Otherwise, an electric shock might occur.

CAUTION

- Connect the plug securely to the electrical outlet to avoid a loose connection.
- Do not pull the power cord when unplugging it. Otherwise, it could become damaged and a fire or an electric shock might occur. Be sure to hold on to the plug when unplugging the power cord.
- If the machine will not be used for a long time, such as during a holiday, unplug the power cord from the electrical outlet for safety.
- Pull out the power plug from the electrical outlet at least once a year and clean the prongs of the plug and their surroundings. Dust collected on these areas can result in fire.



Ground Connection

WARNING





- Be sure to insert the power plug with a ground conductor into the wall outlet with a ground receptacle. Do not use the machine if it is not grounded. It may result in fire or electric shock. 

Handling

WARNING

- Do not place water containers or metallic objects on the machine. If water drips inside the machine or a metallic object drops inside it, a fire or an electric shock might occur.
- Do not remove the covers. Otherwise, you might be electrically shocked by the high-voltage part inside. 
- Do not disassemble or rebuild the machine by yourself. Otherwise, a fire or an electric shock might occur.
- Do not insert or drop any metallic material or flammable substances into the machine through any opening. A fire or an electric shock might occur.
- If something drops inside the unit, immediately press and hold the [Power] key to turn off the power for operations, then turn off the main power switch. Next, unplug the power cord and contact your dealer or authorized service representative. Continued use might result in a fire or an electric shock. 
- If the unit emits excessive heat, smoke or foul odor, immediately press and hold the [Power] key to turn off the power for operations, then turn off the main power switch. Next, unplug all the power cords and contact your dealer or authorized service representative. Otherwise, a fire or an electric shock might occur. 
- When using the IC card reader
The IC card reader continually emits a weak signal. If you are using a cardiac pacemaker and notice any abnormalities, immediately move away from the machine. Consult a physician immediately.

CAUTION

- Do not insert your fingers in the areas around the standard tray (additional tray) or stacking tray. Otherwise, an injury might occur.
- Do not touch the moving parts of the machine. Otherwise, an injury might occur.
- Be careful of protruding parts and metal terminals when inserting the hand inside the printer such as removing jammed paper. Otherwise, an injury might occur.
- The inside of the printer may have areas with ink. Be careful not to let the ink come in contact with your hands or clothing. Should ink accidentally make contact with your hands, wash it off with detergent as soon as possible.
- When moving the machine, contact your dealer or authorized service representative. If you try to forcibly move the machine, the machine may overturn, resulting in injury.
- When using the face down finisher
 -   Caution! A finger is caught.
 - Do not put your fingers in the gap between the main body and stacking tray of the face down finisher. Doing so may result in your fingers being caught while the face down finisher moves.
- When using the multifunction finisher
 -   Caution! A finger is caught.
 - Do not put your fingers in the gap between the main body and stacking tray of the multifunction finisher. Doing so may result in your fingers being caught while the multifunction finisher moves.
 -  Caution! Hot surface
 - Since the parts near the high temperature caution label may be heated and cause burns, do not touch the parts directly with your fingers.

Ink Cartridge

CAUTION

- Avoid contact to eyes and/or skin. If ink gets into your eyes, flush it out immediately with plenty of water. If ink comes into contact with your skin, wash it off thoroughly using soap.
- Allow plenty of ventilation during printing. Seek fresh air immediately if you feel unwell during use.
- If you feel sick, seek medical advice immediately.
- Use the ink only for printing purposes.
- Do not dispose of used ink cartridges by burning. The ink is combustible and can cause the fire to grow, resulting in burns.
- Store ink cartridges out of the reach of children.
- The ink is a combustible liquid. In the event of fire, use potassium carbonate mist, foam, powder, or a carbon dioxide fire extinguisher.

Before Use

This section describes the precautions that must be observed before using the machine.

Installation Location

Observe the following precautions.

- **Your dealer will help you to determine a proper location for the machine at the time of delivery.**
- **When moving the machine, contact your dealer or authorized service representative.**
- **Avoid installing the machine in the following locations. Otherwise, incorrect operation, malfunction, or accident might occur.**
 - Places subject to direct sunlight or excessively illuminated such as next to windows (if inevitable, use a curtain at the window)
 - Places subject to sudden temperature variations
 - Places excessively hot and humid or cold and dry
 - Places close to fire or heat
 - Places directly subject to cold air from air conditioners or hot air from heaters, as well as radiant heat
 - Places with poor air permeability or ventilation
 - Dusty places
 - Places subject to excessive vibration
- **Install the machine in a place whose levelness is within the following specified range.**
Installation surface level: 2° or less
- **Operate the machine under the following environment conditions.**
Temperature range: 15 °C - 30 °C (59 °F - 86 °F)
Humidity range: 40% - 70% RH (non-condensing)

Power Connection

Observe the following precautions.

- **Connect the plug securely to the electrical outlet to avoid a loose connection. You may have two or more power plugs if you have options connected.**
- **Install the machine near an electrical outlet.**
- **When the scanner is connected to the printer using the USB cable, the scanner is turned on and off by the power of the main unit.**

Connecting to a Computer

■ Connecting to Multiple Computers

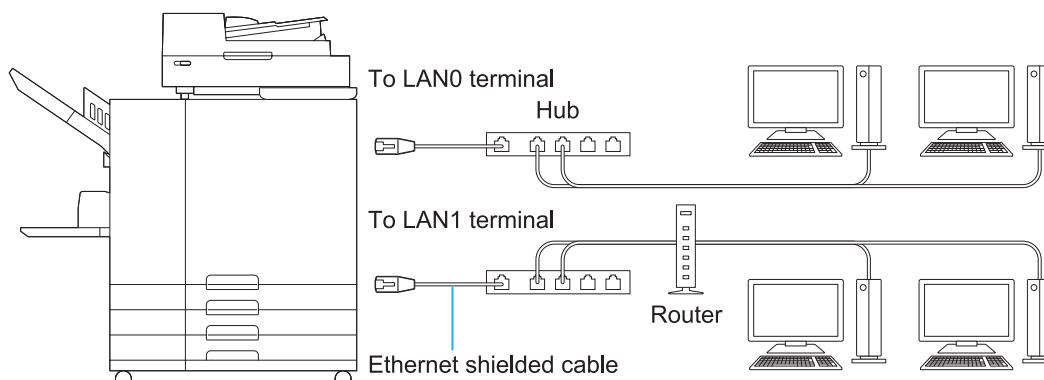

■ Connecting to One Computer

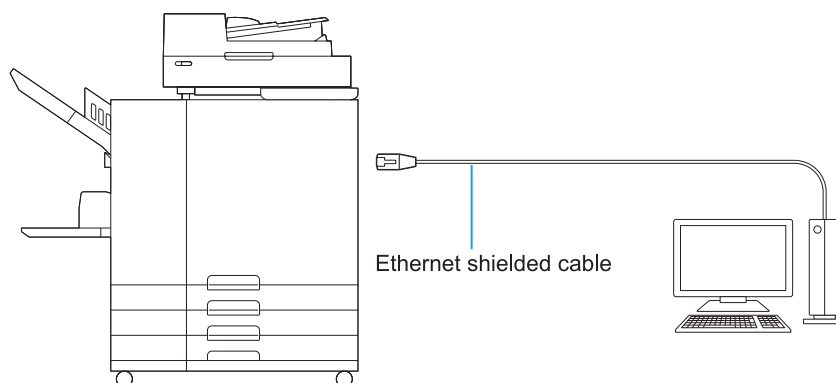

• The maximum allowable voltage for all input/output connection is 5V.



- Use a commercially available ethernet shielded cable. You can use both straight and crossover cables to connect the machine to computers. It is recommended that you use one of the following types of ethernet shielded cables according to your network environment.
 - Cat 5 (Cat 5e) cable for 100BASE network
 - Cat 5e cable for 1000BASE network
- To print from a computer, you must install the printer driver. For the installation method, see "Installing and Uninstalling the Printer Driver" (p.50).
- When connecting the optional print controller, connect to the LAN1 terminal on the rear of the machine.
- You cannot directly connect the machine to a communication line offered by a telecommunication carrier (mobile communications company, fixed-line telecoms company, Internet provider, etc.) When connecting the machine to the network, make sure that the connection is made via a router etc.

Required Spacing

■ Main Unit

Provide sufficient space for the front cover to open.

- As seen from the front (with the standard tray open)
- As seen from the side (with the front cover open)

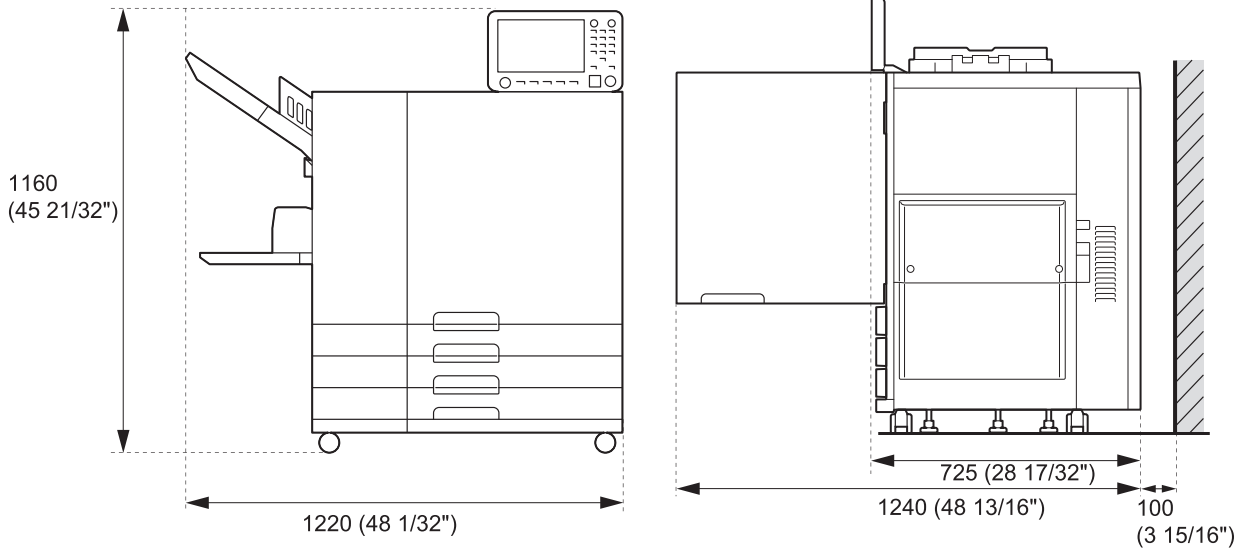

Units: mm (inch)

■ Main Unit with Optional Equipment Installed

Provide sufficient space for opening the standard tray, the front cover, and the original cover of the scanner.

- As seen from the front

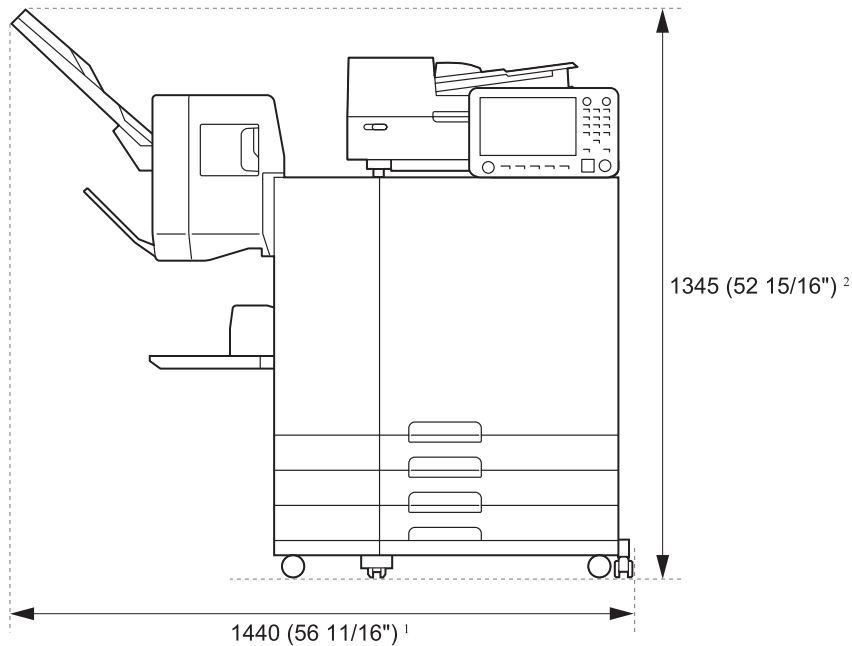

Units: mm (inch)

- As seen from the side

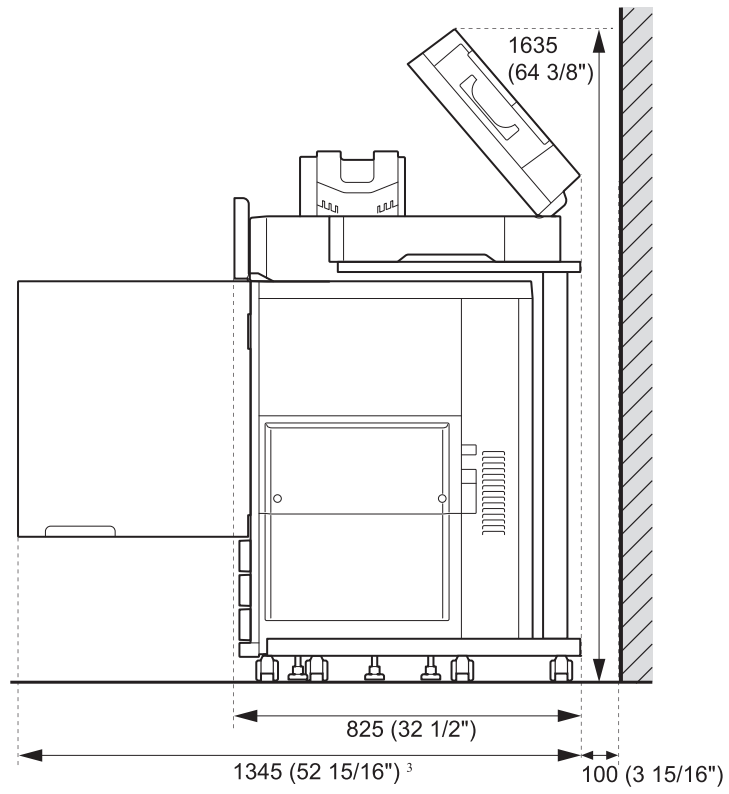

Units: mm (inch)

The size varies depending on the optional equipment used.

*1 Width	Main unit only	1,220 mm (48 1/32")
	Main unit and Scanner (when using special scanner stand)	1,235 mm (48 19/32")
	Main unit and Face Down Finisher	1,440 mm (56 11/16")
	Main unit, Multifunction Finisher, and Folder Unit	2,655 mm (104 17/32")
	Main unit and Multifunction Finisher	2,415 mm (95 3/32")
	Main unit and Wide Stacking Tray	1,875 mm (73 13/16")
	Main unit and Auto-Control Stacking Tray	1,745 mm (68 11/16")
	Main unit, Face Down Finisher, and Wide Stacking Tray	2,100 mm (82 11/16")
	Main unit, Face Down Finisher, and Auto-Control Stacking Tray	1,970 mm (77 9/16")
	Main unit, Face Down Finisher, and High Capacity Stacker	2,425 mm (95 15/32")
	Main unit and Additional Tray	1,480 mm (58 9/32")
	Main unit, Additional Tray, and Wide Stacking Tray	2,135 mm (84 1/16")
	Main unit, Additional Tray, and Auto-Control Stacking Tray	2,005 mm (78 15/16")
	Main unit, Additional Tray, and High Capacity Stacker	2,470 mm (97 1/4")
	Main unit, Additional Tray, Multifunction Finisher, and Folder Unit	2,915 mm (114 3/4")
	Main unit, Additional Tray, and Multifunction Finisher	2,670 mm (105 1/8")
	Main unit and High Capacity Feeder	1,565 mm (61 19/32")
	Main unit and High Capacity Stacker	2,210 mm (87")
	Main unit, High Capacity Feeder, and High Capacity Stacker	2,555 mm (100 9/16")
	Main unit, High Capacity Feeder, and Wide Stacking Tray	2,225 mm (87 19/32")
	Main unit, High Capacity Feeder, and Auto-Control Stacking Tray	2,095 mm (82 15/32")
Main unit, High Capacity Feeder, Multifunction Finisher, and Folder Unit	3,000 mm (118 1/8")	
Main unit, High Capacity Feeder, and Multifunction Finisher	2,760 mm (108 21/32")	

*2 Height	Main unit only (with the operation panel in the upright position)	1,160 mm (45 21/32")
	Main unit and Scanner (when using special scanner stand)	1,260 mm (49 19/32")
	Main unit and Face Down Finisher	1,345 mm (52 15/16")
	Main unit and Multifunction Finisher	1,215 mm (47 27/32")
*3 Depth	Main unit only	1,240 mm (48 13/16")
	Main unit and Scanner (when using special scanner stand)	1,345 mm (52 15/16")
	Main unit and Multifunction Finisher	1,325 mm (52 5/32")
	Main unit, Multifunction Finisher, and Folder Unit	1,325 mm (52 5/32")
	Main unit, Scanner (when using special scanner stand), Multifunction Finisher, and Folder Unit	1,420 mm (55 29/32")
	Main unit and Additional Tray	1,240 mm (48 13/16")
	Main unit and High Capacity Feeder	1,240 mm (48 13/16")
	Main unit and High Capacity Stacker	1,315 mm (51 3/4")

Handling

- Do not use the main power switch to turn off the machine or unplug the machine during operation.
- Do not open any of the covers during operation.
- Do not move the machine.
- The machine contains precision components and moving parts. Therefore, do not perform operations not described in the guides.
- Do not place heavy objects on the machine or subject the machine to strong shocks.
- Open and close the covers gently.
- After turning off the main power switch, wait until the [Main Power] LED goes off before turning on the main power switch again.
- Perform head-cleaning if the machine will not be used for a long time or before using the machine after a long period of non-use. Ink may deteriorate or dry up in the ink feed path inside the machine, resulting in clogging of the print head. It is recommended that head-cleaning be performed regularly to prevent this from occurring.
- Do not touch the print head, as this can result in malfunction or deterioration in print quality.
- Always keep all the color ink cartridges in the machine. Do not leave the machine with the ink cartridges removed, even when not using the machine.

Originals

If you connect the optional scanner, you can copy or scan an original by placing it on the platen glass or in the ADF to be read. If you use an original that is not compatible with this machine, it may result in problems such as paper jamming, soiling or malfunctions.

Specifications of Original Source

■ Platen Glass

Size	Maximum: 303 mm × 432 mm (11 15/16" × 17")
Original Weight	200 N (over an A3-size area)

■ Auto Document Feeder (ADF)

Size	100 mm × 148 mm - 297 mm × 432 mm (3 15/16" × 5 27/32" - 11 11/16" × 17")
Weight	52 g/m ² - 128 g/m ² (14-lb bond - 34-lb bond)
Original Type	Plain paper
Max. Capacity	200 sheets (when the weight is 80 g/m ² (21-lb bond))

Precautions About Originals

Originals that have ink or correcting fluid must be dried before being placed on the platen glass. The following types of originals cannot be scanned using the ADF, even when within the above specification range.

Use the platen glass instead.

- Paper that has been cut and pasted
- Heavily wrinkled or curled paper
- Folded paper
- Glued paper
- Paper with holes
- Torn paper or paper with irregular edges
- Transparencies, tracing paper, and other highly transparent materials
- Art paper or coated paper with a processed surface on the front or back
- Thermal paper for fax machines or word processors
- Paper with an uneven surface

To accurate scanning

- When scanning photos or printed documents, make sure the surface of the original is flat.
- We recommend that you use an original with a font size of at least 5pt.

Printable Area

The size of the printable area varies depending on whether you are printing a job from a computer or copying a paper original.

Maximum Print Area

Printable Area

Printing	314 mm × 548 mm (12 11/32" × 21 9/16")
Copying (When using the Auto Document Feeder)	295 mm × 430 mm (11 5/8" × 16 15/16")*

* When using the platen glass: 303 mm × 432 mm (11 15/16" × 17")

Printable Area (Margin)

Standard	3 mm (1/8")
Maximum	1 mm (3/64")



- Printing without margins cannot be performed. Margins are always added around the edges of the paper.

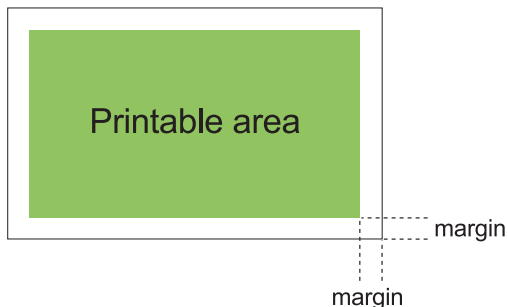

Some areas around the edges of the paper cannot be printed regardless of the data size of the original.

- Depending on the content of the original, text or images may be lost or bleeding may occur.
- Even when the paper size is within the maximum print area, a margin is always provided.
- When copying, the machine cannot scan the 1 mm (3/64") margin of the original.

Printable Area of Envelopes

The following envelopes of the standard size can be printed on this machine:

- C4: 229 mm × 324 mm (9" × 12 3/4")
- C5: 162 mm × 229 mm (6 3/8" × 9")
- C6: 114 mm × 162 mm (4 1/2" × 6 3/8")
- DL R: 110 mm × 220 mm (4 5/16" × 8 21/32")
- Envelope 229 mm × 305 mm (9" × 12")
- Envelope 254 mm × 331 mm (10" × 13")
- NO.10 envelope 105 mm × 242 mm (4 1/8" × 9 1/2")

To print on the envelopes of the non-standard size, register the envelope size using [Custom Paper Entry] on the [Environment] tab of the printer driver.

The printable area on envelopes is the area enclosed within 10 mm (13/32") of the edges of the envelope.

Any part of the image that does not fit within the printable area is not printed.

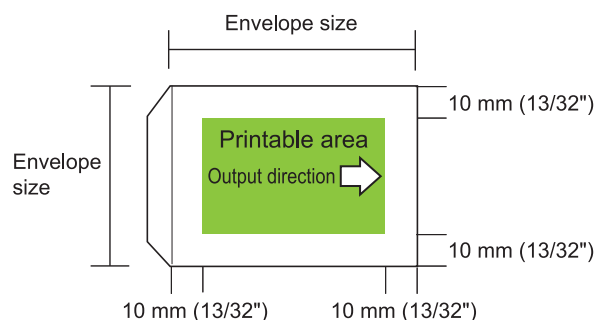

- When printing on envelopes, it is recommended you install the optional stacking tray or the envelope feed kit.
- To also print on the flap section, you must register the envelope size including the flap section.
- You cannot use duplex print when printing on envelopes.

Printing Paper

- If you use paper that is not compatible with this machine, it may result in problems such as paper jamming, soiling or malfunctions.
- For paper which can be loaded in the feed tray, standard tray, and the additional tray, their specifications are different.

Paper Basic Specifications

Feed Tray

Size	182 mm × 182 mm - 297 mm × 432 mm (7 3/16" × 7 3/16" - 11 11/16" × 17")
Weight	52 g/m ² - 104 g/m ² (14-lb bond - 28-lb bond) Ream weight: 45 kg - 90 kg (99 lb - 198 lb) (duodecimo)
Paper Type	Plain paper, recycled paper
Maximum Load	Height up to 56 mm (2 3/16") in each tray

Standard Tray/High Capacity Feeder

Size	Standard tray: 90 mm × 148 mm - 340 mm × 550 mm (3 9/16" × 5 27/32" - 13 3/8" × 21 5/8") High capacity feeder: 90 mm × 148 mm - 340 mm × 465 mm (3 9/16" × 5 27/32" - 13 3/8" × 18 5/16")
Weight	46 g/m ² - 210 g/m ² (12-lb bond - 56-lb bond) Ream weight: 40 kg - 180 kg (88 lb - 397 lb) (duodecimo)
Paper Type	Plain paper, recycled paper, envelopes, postcards (plain paper), postcards (inkjet)
Maximum Load	Standard tray: Height up to 110 mm (4 5/16") High capacity feeder: Height up to 440 mm (17 11/32")

Additional Tray

Size*	A4-LEF/JIS-B5-LEF/Letter-LEF/16K-LEF
Weight	52 g/m ² - 104 g/m ² (14-lb bond - 28-lb bond)
Paper Type	Plain paper, recycled paper
Maximum Load	Height up to 220 mm (8 21/32")

* When changing the paper size (paper guide position), contact your dealer or authorized service representative.

- **Acceptable paper sizes depend on the output tray.**

Paper sizes for output trays

Face down tray	90 mm × 148 mm - 340 mm × 550 mm (3 9/16" × 5 27/32" - 13 3/8" × 21 5/8")* ¹
Face down finisher	When printouts are not collated: 90 mm × 148 mm - 340 mm × 550 mm (3 9/16" × 5 27/32" - 13 3/8" × 21 5/8")* ¹ When offset output is applied: Regular sized paper: 182 mm × 257 mm - 297 mm × 431.8 mm (7 3/16" × 10 1/8" - 11 11/16" × 17") Irregular sized paper: 131 mm × 148 mm - 305 mm × 550 mm (5 3/16" × 5 27/32" - 12" × 21 5/8") When you use staples: A3/JIS-B4/A4/A4-LEF/JIS-B5/JIS-B5-LEF/Ledger/Legal/Letter/Letter-LEF/Foolscap/8K/16K/16K-LEF Only regular sized paper.
Auto-control stacking tray	90 mm × 148 mm - 320 mm × 432 mm (3 9/16" × 5 27/32" - 12 19/32" × 17") (When using paper exceeding 432 mm (17"), close the paper guides.)
Wide stacking tray	90 mm × 148 mm - 340 mm × 550 mm (3 9/16" × 5 27/32" - 13 3/8" × 21 5/8")

High capacity stacker	<p>When printouts are not collated: 90 mm × 148 mm - 340 mm × 460 mm (3 9/16" × 5 27/32" - 13 3/8" × 18 1/8")^{*2}</p> <p>When offset output is applied: 90 mm × 182 mm - 340 mm × 432 mm (3 9/16" × 7 3/16" - 13 3/8" × 17")^{*3}</p>
-----------------------	--

*1 Envelopes are not acceptable.

*2 Height up to 440 mm (17 11/32")

For A5, postcards, envelopes, or irregular sized paper:
height up to 110 mm (4 5/16")

*3 Height up to 405 mm (15 15/16") (not applicable to A5, postcards, envelopes or irregular sized paper)



- For information on each tray in the multifunction finisher, see "Multifunction Finisher FG20 (Optional)" (p.249) in "Appendix".

- LEF stands for "Long Edge Feed".



- **Depending on the type of paper, operating environment, and storage conditions, even paper meeting these size and weight specifications may not be able to pass through the machine in some cases.**

■ **Do not use the following paper types as they will cause problems such as paper jamming or malfunctions.**

- Paper that does not comply with the conditions in the basic specifications
- Paper with a processed surface, such as thermal paper or carbon paper
- Curled paper (3 mm (1/8") or more)
- Paper with wrinkles
- Bent paper
- Torn paper
- Paper with ripples
- Coated paper such as art paper
- Paper with jagged edges
- Glued paper
- Paper with holes
- Glossy paper for photographs
- Transparencies
- Yupo paper

■ **Always use paper from a sealed package.**

■ **After finishing the print job, return the unused paper from the standard tray to the package and store. If you leave the paper in the standard tray, the paper may curl and cause paper jamming. (It is recommended to take necessary sheets out of the wrapping paper and load them to the standard tray.)**

- **If the paper is not cut cleanly or has a textured surface (such as drawing paper), fan the paper before use.**
- **Store paper flat, away from high temperatures, high humidity, and direct sunlight.**

Printouts

- When using duplex printing, the edges of the paper may become dirty depending on the original.
- Printouts lose their color (discolor) over time due to various chemicals in the air and light. You can protect printouts against discoloration by allowing the printout to fully dry and then inserting it into a glass frame or laminating it.
- When storing printouts in a clear file folder, be sure to use only those made of polyethylene terephthalate (PET).
- Printouts can lose color when they come in contact with water or sweat. Avoid storing printouts in a place subject to moisture. Writing on printouts with an oil-based pen can cause bleeding.
- The print density of the printout immediately after printing differs from the print density 24 hours later.
Print density decreases over time.
- Do not place printouts from this machine on top of printouts from a laser printer or copier that uses toner.
The paper might stick to the printed toner and the toner might transfer to the printout.
- Do not place printouts from this machine on or beneath the thermal paper or pressure-sensitive paper. Image on the thermal paper or pressure-sensitive paper might lighten or vanish.
- The printouts include very small quantities of volatile components. When printouts are left on a place such as on a desk, in rare cases it may look as if the volatile components may have transferred on to that item. However, they will evaporate and disappear over time.

Materials Not to Be Printed

- Do not use the machine in any manner which violates the law or infringes on established copyrights, even when making copies for personal use. For more information, contact your dealer or authorized service representative. In general, use discretion and common sense.

Ink Cartridge Storage and Handling Precautions

The ink cartridges for this machine are partly made of paper. For this reason, cartridges may become deformed and unusable if stored incorrectly or in an unsuitable environment. Store the ink cartridges properly, according to "Storage".

Storage

- When storing the ink cartridge, keep the ink cartridge in the original package, and store it horizontally in the direction indicated by the this-side-up mark.
- Avoid freezing or placement under direct sunlight. Store in areas between 5 °C and 35 °C (41 °F - 95 °F).
Do not store in locations subject to extreme changes in temperature.
- If the plastic bag is opened but the ink cartridge is not to be used right away, store the ink cartridge properly and insert it into the machine as soon as possible.

Handling Precautions

- Do not shake the ink cartridge. This can create bubbles, resulting in a deterioration in print quality.
- Do not add ink into the ink cartridge.
- Remove the ink cartridge from its plastic bag just before inserting it into the machine.

- Adequate operation temperature is 15 °C - 30 °C (59 °F - 86 °F).
Using the ink cartridge outside the adequate operation temperature range can result in a deterioration in print quality (reduced ink discharge).
The spraying properties of the inkjet printer can vary depending on the ink viscosity. In particular, at lower temperatures, the ink viscosity increases and can result in clogging of the print head. Follow the information on the operation environment and storage temperature, check the manufacturing date, and use the ink cartridge within 24 months from the date of manufacture.
- If the cap of the ink cartridge is removed and the ink cartridge is left for a long period of time without being used up, various chemicals in the air can cause the ink cartridge to deteriorate.
Using ink that has deteriorated or changed in quality can damage the print head or ink flow path.
- Do not dump the ink left in the cartridge into the sewers.
- The ink is a combustible liquid.
In the event of fire, use potassium carbonate mist, foam, powder, or a carbon dioxide fire extinguisher.

Disposing of Used Ink Cartridges and Cleaning Tanks

- The ink in the cleaning tank cannot be used for printing.

Part Names and Functions

Main Unit and Optional Scanner

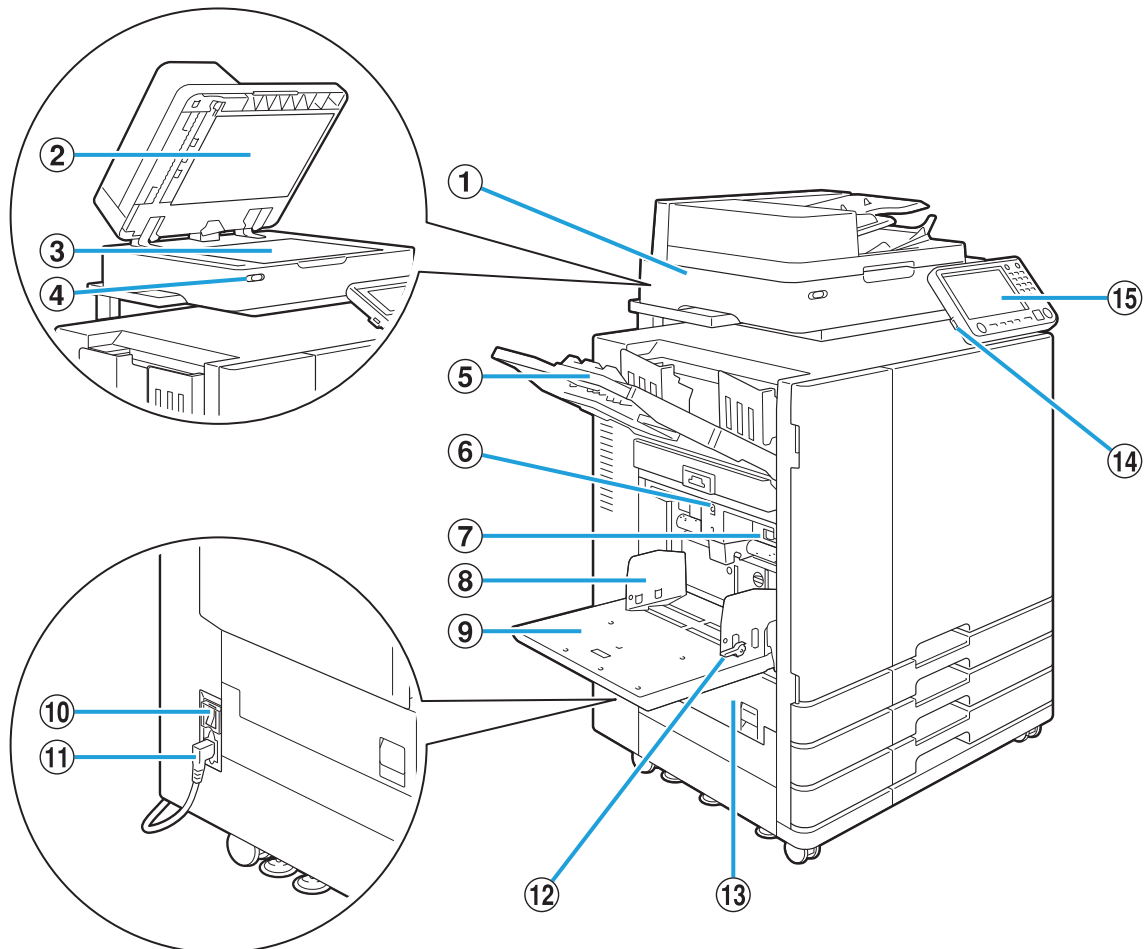

① Scanner (Optional)

Use the scanner to copy or scan documents that are read from the platen glass or the ADF.

② Original Cover

Pull down to cover the original when reading it on the platen glass.

③ Platen Glass

Set the original face down and aligned with the position of the arrow in the top left.

④ Scanner LED (Blue / Red)

This LED indicates the status of the scanner.

- Blue LED ON: Ready
- Blue LED flashing: Machine is starting up or scanning
- Red LED flashing: Error has occurred

⑤ Face Down Tray

Printouts are output face down.

⑥ Standard Tray Descent Button

Use this button to move the standard tray up or down when replacing or adding the paper to it.

⑦ Paper Feed Pressure Adjustment Lever

Use this lever to adjust the paper feed pressure to suit the paper type in the standard tray.

⑧ Standard Tray Paper Guide

This guide prevents paper in the standard tray from becoming misaligned.

⑨ Standard Tray

Load special paper (thick paper, envelopes, etc.) here. You can also load plain paper.

⑩ Main Power Switch

Use this switch to turn on the power. Usually the power is left ON.

⑪ Main Unit Socket

Connect the main unit power cable to this socket.

⑫ Paper Feed Guide Levers

Use these levers to slide or fix the standard tray paper guide. Levers are located on both sides of the standard tray paper guide, in two places.

⑬ Left Cover

Open this cover when there is a paper jam.

⑭ USB Port

Connect a USB flash drive to this port to save the scanned data or to print the data saved on a USB flash drive.



- You need to use the USB flash drives compatible with Mass Storage Class and file system format (FAT16, FAT32, exFAT).

⑮ Operation Panel

Use to perform operations or settings. You can adjust the angle so that it is easier to see.

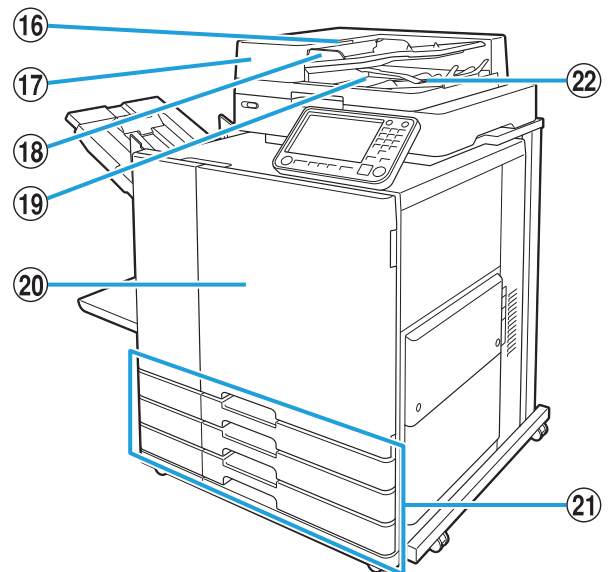
**⑯ ADF Original Unit Lever**

Pull this lever up to open the ADF original unit cover when documents are jammed.

⑰ Auto Document Feeder (ADF)

Up to about 200 documents can be automatically fed.

⑱ ADF Original Guide

Slide to fit the width of the document.

⑲ ADF Original Output Tray

Documents that are read from the ADF are output here.

⑳ Front Cover

Normally the front cover is locked and cannot be opened. This lock is automatically released when a paper jam or other problems occur.

To open the front cover in other cases, go to [Maintenance] from the [Home1] screen and touch [Front Cover Release].

㉑ Feed Tray 1, Feed Tray 2, Feed Tray 3 (Feed Trays)

Load the paper to be used for printing here.



- Use the standard tray for thick paper and other special paper types.

㉒ Paper Alignment Lever

Use this lever to align the documents that are output. If the lever interferes with output, pull it up and lock it.

Operation Panel

Various operations and settings can be performed using the operation panel. The color and condition (light up or flashing) of the LEDs indicate the machine status or errors such as paper jams.

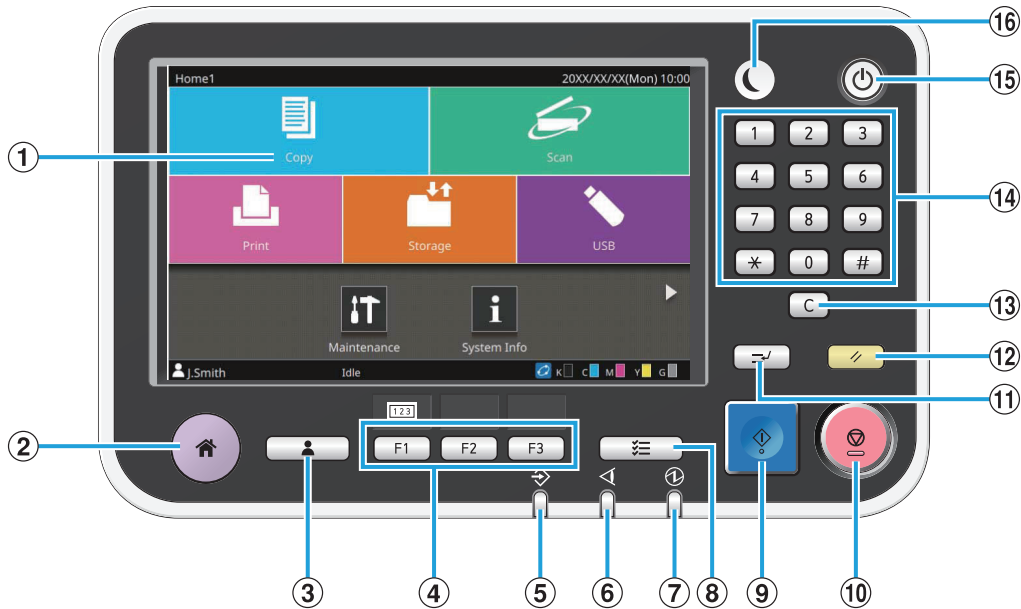

① Touch Panel

Use to perform operations or settings. This panel also displays information such as error messages and confirmation messages.

Depending on the screen or list, flick operations may be available by flicking your finger in a certain direction on the touch panel.

(p.32 "Touch Panel")

② Home Key

Press this key to bring up the [Home1] screen.

③ Login / Logout Key

Press this key to log in or log out.

④ Function Keys

You can preset frequently used functions and settings. Use these keys as shortcut keys.



- For specific instructions on how to register functions and settings, contact your administrator.

⑤ Data LED

This LED lights up when there is a job waiting and flashes when this machine is receiving data.

⑥ Error LED

This LED flashes when an error occurs.

⑦ Main Power LED

This LED lights up when the main power is on.

⑧ Job Status Key

Press this key to check jobs that are in progress or finished.

⑨ Start Key

Press this key to start an operation.

⑩ Stop Key

Press this key to stop the job that is in progress.

⑪ Interrupt Key

Press this key when you need to copy while a job is being printed. This function allows you to pause the job being printed to start copying another document.

⑫ Reset Key

Press this key to return the settings to their default values.



- Only the settings for the selected mode are reset. The settings for other modes remain unchanged by this operation.

⑬ Clear Key

Press this key to clear letters or numbers that have been entered.

⑭ Numeric Keys

Use these keys to enter numbers.

⑮ Power Key

When you press this key while the main power is on, the operation power turns on and this key lights up. Holding it turns off the operation power, and the machine goes into stand-by mode.

⑯ Wake Up Key

This key lights up when this machine is in power saving mode. Pressing this key when it is lit makes the machine ready for operation.



- Pressing this key when it is not lit makes the machine go into sleep mode.
-

Touch Panel

[Home1] Screen

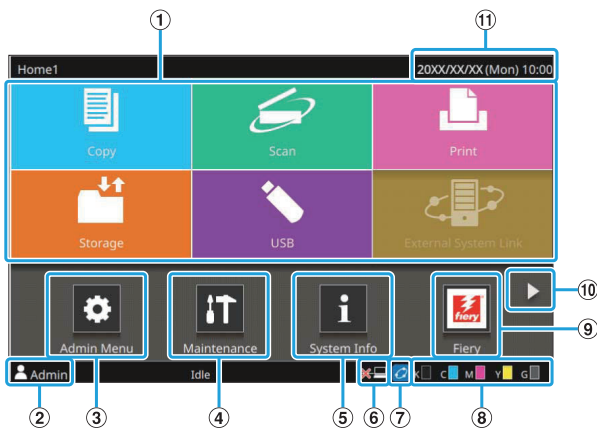

The [Home1] screen appears when you press the [Home] key in the operation panel. To access the settings and operations, touch the button for the mode that you want to use.



- The screen displayed varies depending on your model, the optional equipment connected, and settings.

① Mode Buttons

Touch these buttons to bring up the corresponding mode screen.
A lock icon in the upper right corner of a button indicates that you must log in to access that mode.

② User Name

The name of the user currently logged in is displayed.

③ [Admin Menu] Button

Touch this button to access the administrator settings.



- This button does not appear when the user is not logged in as an administrator.

④ [Maintenance] Button

Touch this button to access maintenance features.

⑤ [System Info] Button

Touch this button to display consumables, machine, and user information.

⑥ Offline

This icon is displayed when [Online/Offline] is set to [OFF].

⑦ FORCEJET™ Link Icon

This icon indicates whether all parts required for printing are working correctly. The display will differ depending on the consumable or configured details.

- You are using RISO ink.
- You are using non-RISO ink.

When lit: Ink information is entered.

When flashing: Ink information is not entered.

For more information on setting ink information, see the "Troubleshooting Guide".

⑧ Remaining Amount of Ink

These icons indicate the amount of remaining ink for each color. The indicator starts flashing when the time to replace an ink cartridge comes close. Prepare a new ink cartridge for the color that flashes.



- If you are not using RISO ink, the remaining amount of ink is not displayed.

⑨ [Fiery] Button

This button is displayed when using the optional print controller ComColorExpress FS2100C. Touch this button to show the Fiery mode screen.

For more information, see the user's guide for the print controller.

⑩ [Play] Button

Touch this button to move to the [Home2] screen.

⑪ Date/Time

The current date and time is displayed.

[Home2] Screen

Displayed by touching [▶] or flicking the screen to the left on the [Home1] screen.

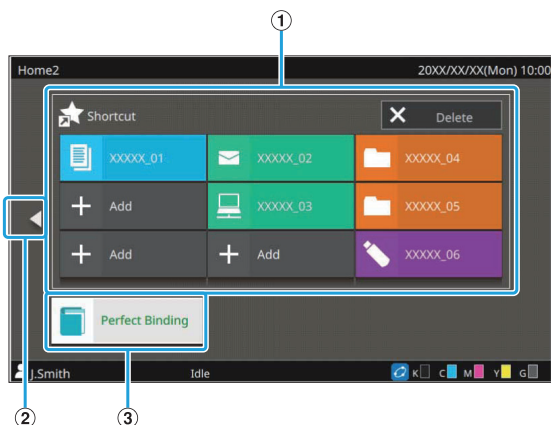

① [Shortcut]

You can register up to nine shortcuts to the favorites of each mode on the [Home2] screen.

② ◀ Button

Touch this button to display the [Home1] screen.



- You can also flick to the right on the [Home2] screen to display the [Home1] screen.

③ [Perfect Binding] Button

This button is displayed when using the optional Perfect Binder. Printed body pages and a cover can be set to bind an entire book.

For more information, see the user's guide for the Perfect Binder.

Favorite Shortcuts

You can register up to nine shortcuts to your personal [Favorites] registered for each mode.

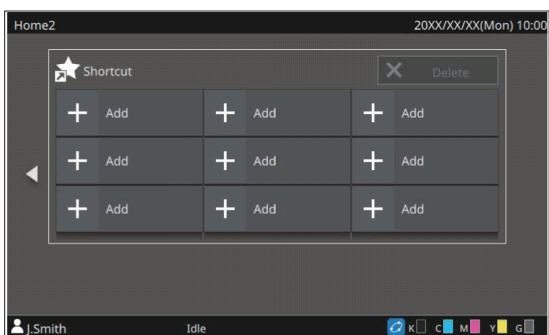

■ Registering a favorite shortcut

- 1 Display the [Home2] screen.
- 2 Touch [Add].
The [Add Favorite Shortcut] screen is displayed.
- 3 Select the mode.
- 4 Select one of the favorites.
- 5 Touch [OK].



- The button color and type of icon for favorite shortcuts registered to the [Home2] screen will differ depending on the mode the favorite is applicable to.

■ Deleting a favorite shortcut

- 1 Display the [Home2] screen.
- 2 Touch [Delete].
- 3 Select the shortcut you wish to delete.
A check will be placed on the selected shortcut.
- 4 Touch [Delete].
The [Confirm] screen is displayed.
- 5 Touch [OK].

Mode Screens

Pressing a mode button on the [Home1] screen will bring up the corresponding mode screen.

[Copy] Screen

If you are using an optional scanner, you can operate or check copy jobs on this screen.

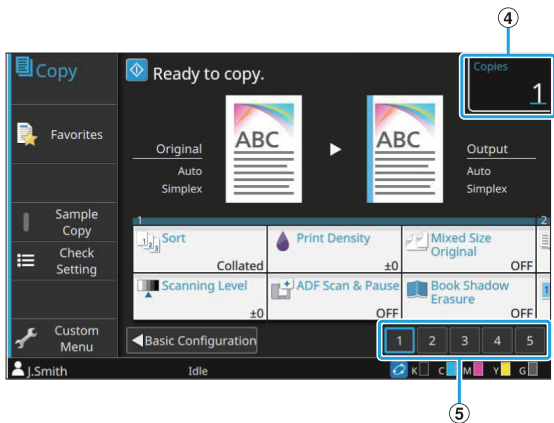
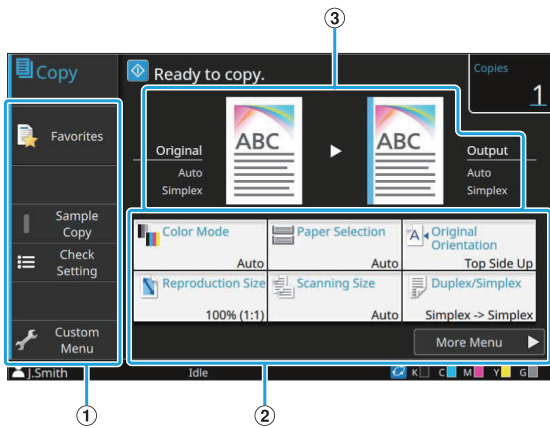

① Function Buttons

Select a function that can be used in Copy mode.

② Setting Buttons

Use these buttons to set up copy functions.
Touch [More Menu] to display other setting buttons.

③ Original Image and Finishing Image

The setting details can be confirmed with the icons that are displayed.
The image of the original is shown on the left while the image of the finishing is shown on the right.

④ [Copies]

Enter or check the number of copies here.

⑤ Page Switching Buttons

Use these buttons to switch the setting button pages.
You can also switch pages by dragging the area of the setting buttons to the left or right.

[Scan] Screen

If you are using an optional scanner, you can operate or check scan jobs on this screen.
There are three ways to transmit scan data.

■ Mail

You can send the scanned data by e-mail.

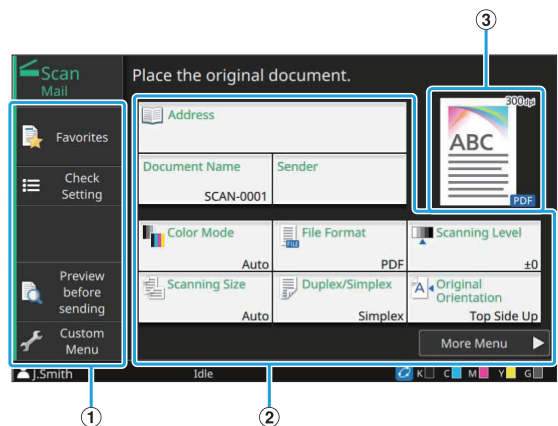

① Function Buttons

Select a function that can be used in Scan mode.

② Setting Buttons

Use these buttons to enter [Address], [Document Name], and [Sender] as well as to set up scanner functions.
Touch [More Menu] to display other setting buttons.

③ Finishing Image

The setting details can be confirmed with the icons that are displayed.

■ PC

You can send the scanned data to a computer on the network.

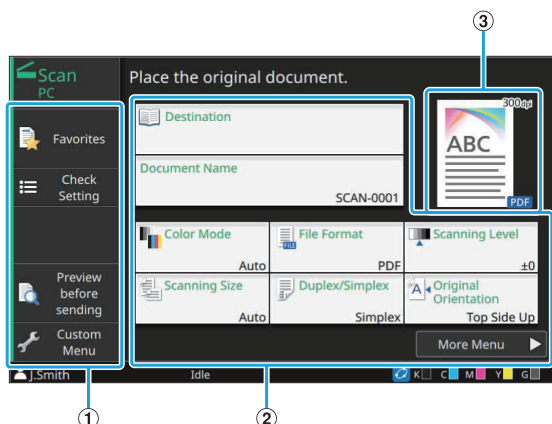

① Function Buttons

Select a function that can be used in Scan mode.

② Setting Buttons

Use these buttons to enter [Destination] and [Document Name] as well as to set up scanner functions.

Touch [More Menu] to display other setting buttons.

③ Finishing Image

The setting details can be confirmed with the icons that are displayed.

■ Console

You can save the scanned data to the internal SSD of the machine. The saved data can be downloaded from the RISO console.

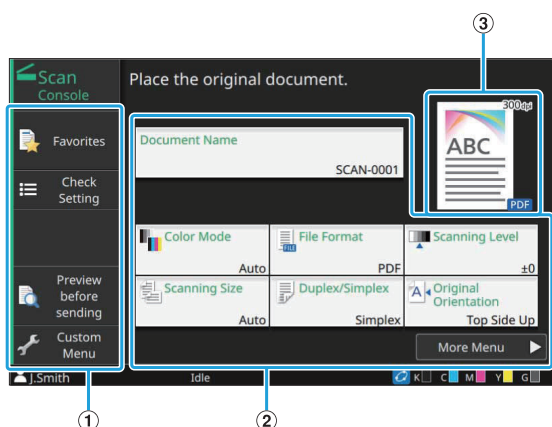

① Function Buttons

Select a function that can be used in Scan mode.

② Setting Buttons

Use these buttons to enter [Document Name] as well as to set up scanner functions.

Touch [More Menu] to display other setting buttons.

③ Finishing Image

The setting details can be confirmed with the icons that are displayed.

[Print] Screen

On this screen, you can operate and check print jobs that are sent from a computer.

■ Waiting Job List Screen

Thumbnail Display

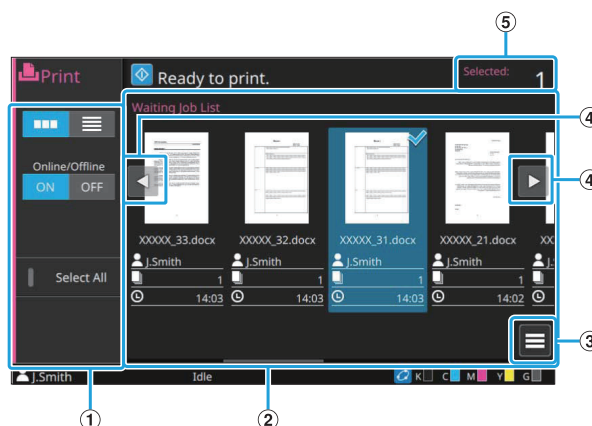

List display

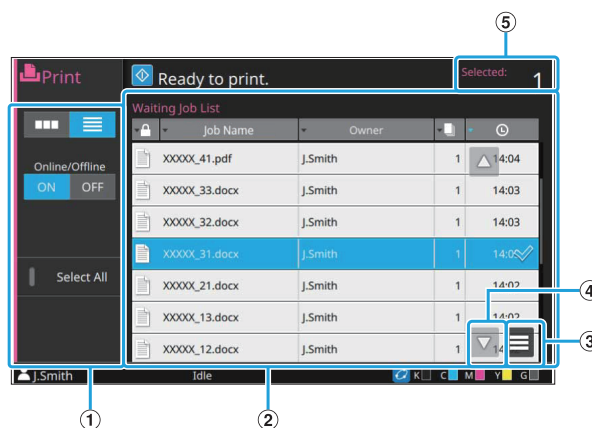

① Function Buttons

Select a function that can be used in Print mode.

② View

Waiting jobs are listed in this view.

③ Sub Menu

You can check the details and edit or delete the settings for the selected job.

④ ◀/▶/▲/▼ Buttons

Use these buttons to scroll through the list.

- ⑤ [Selected]
The number of selected jobs is displayed.

Change Setting Screen

This screen appears when you select [Change Setting] in the sub menu on the [Waiting Job List] screen.

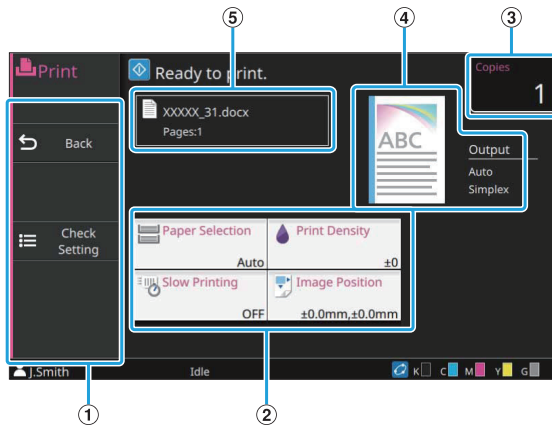

- ① Function Buttons
Select a function that can be used in the change setting screen.
- ② Setting Buttons
Use these buttons to set up print functions.
- ③ [Copies]
Enter or check the number of copies to print.
- ④ Finishing Image
The setting details can be confirmed with the icons that are displayed.
- ⑤ Document Name
The name of the selected document is displayed here.

[Storage] Screen

You can operate and check stored jobs on this screen.
The Storage mode has two functions: [Save], which allows you to save data to a folder, and [Load], which enables printing of documents saved in a folder.

View Screen in [Storage] - [Save]

Icon display

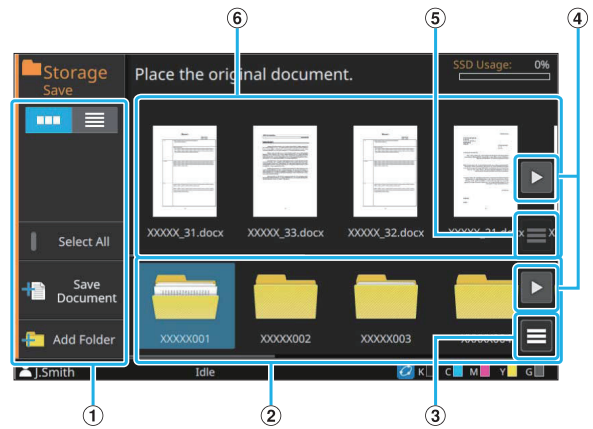

List display

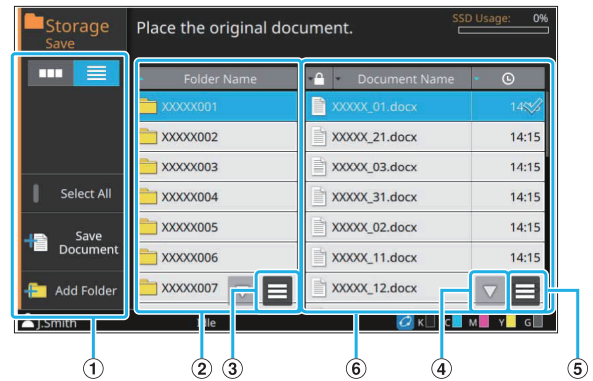

- ① Function Buttons
Select a function that can be used in Storage mode.
- ② Folders Display
Folders that can be used are displayed in a list in this view.
- ③ Sub Menu
Click this button to change the color or name of the selected folder.
- ④ ◀/▶/▲/▼ Buttons
Use these buttons to scroll through the list.
- ⑤ Sub Menu
The following settings are available for selected documents:
 - Details
 - Rename
 - Delete
- ⑥ Documents List
The documents saved in the selected folder are displayed in a list.



- In the list display, you can touch one of the titles to sort the items on the list. The list can be sorted in the ascending or descending order based on the folder name, configuration of a PIN code, document name, or date and time of save.

■ Save Document Screen in [Storage] - [Save]

This screen appears when you touch [Save Document] on the list screen.

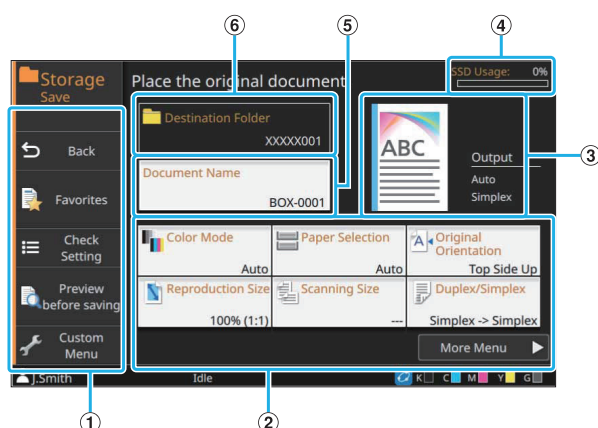

① Function Buttons

Select a function that can be used in Storage mode.

② Setting Buttons

Use these buttons to set up storage (save) functions.

③ Finishing Image

The setting details can be confirmed with the icons that are displayed.

④ [SSD Usage] Indicator

The space on the internal SSD currently being used is indicated as a percentage.

⑤ [Document Name] Button

Press this button to open the [Document Name Setting] screen. Use this button to name a document.

⑥ [Destination Folder]

The name of the destination folder selected on the list screen is displayed here.



- If the available space on the internal SSD is low, delete unnecessary documents in the folder to increase available space.
- You can save up to 1,000 files in one folder.

■ View Screen in [Storage] - [Load]

Icon display

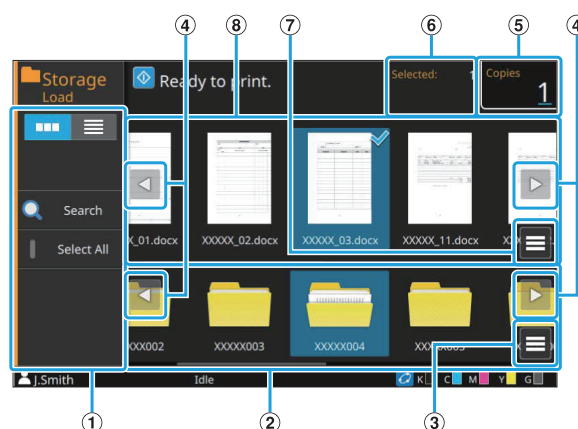

List display

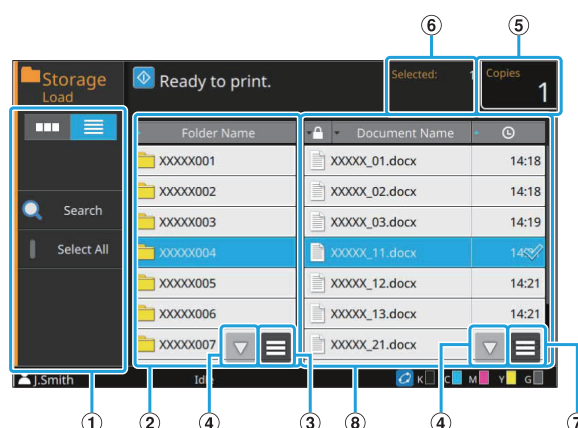

① Function Buttons

Select a function that can be used in Storage mode.

② Folders Display

Folders that can be used are displayed in a list in this view.

③ Sub Menu

Click this button to change the color or name of the selected folder.

④ ◀/▶/▲/▼ Buttons

Use these buttons to scroll through the list.

⑤ [Copies]

Enter or check the number of copies to print.

⑥ [Selected]

The number of selected documents is displayed here.

⑦ Sub Menu

The following settings are available for selected documents:

- Details
- Change Setting
- Rename
- Delete

- Copy to USB Drive
- Copy to Folder

⑧ Documents Display

The documents saved in the selected folder are displayed in a list.



- In the list display, you can touch one of the titles to sort the items on the list. The list can be sorted in the ascending or descending order based on the folder name, configuration of a PIN code, document name, or date and time of save.

[USB] Screen

You can operate and check USB jobs on this screen.

The USB mode has two functions: [Save], which allows you to save the scanned data to a USB flash drive, and [Load], which enables printing of documents (PRN files) saved to a USB flash drive from the printer driver.

For information on how to save documents on a USB flash drive, see "Output and Destination" (p.111) in "Printing".



- Files which can be printed are those in the PRN format only.
- PRN files are output by the printer driver in a format that was developed exclusively for RISO KAGAKU CORPORATION. PRN files cannot be opened using printers or applications by other manufacturers.

■ View Screen in [USB] - [Save]

Icon display

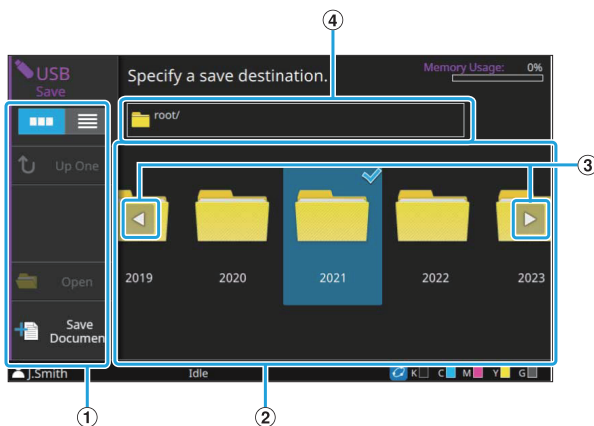

List display



① Function Buttons

Select a function that can be used in USB mode.

② Folders Display

Folders that can be used are displayed in a list in this view.

③ ◀/▶/▲/▼ Buttons

Use these buttons to scroll through the list.

④ Folder Path Display

Displays the full path for the location of the selected folder within the USB flash drive.



- In the list display, you can touch one of the titles to sort the items on the list. The list can be sorted in the ascending or descending order based on the folder name.

■ Save Document Screen in [USB] - [Save]

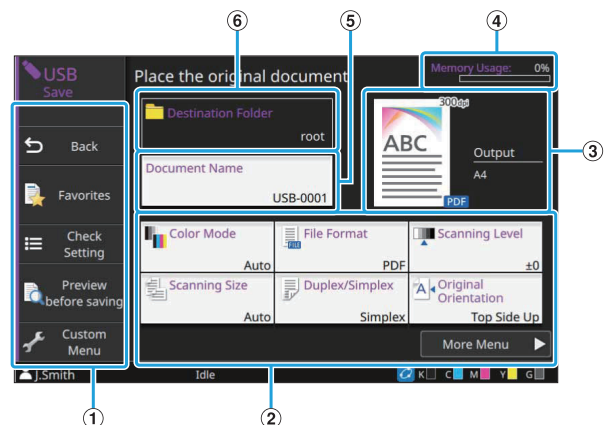

① Function buttons

Select a function that can be used in USB mode.

② Setting Buttons

Use these buttons to set up USB Save functions. Touch [More Menu] to display other setting buttons.

③ Finishing Image

The setting details can be confirmed with the icons that are displayed.

④ [Memory Usage] Indicator

The space on the USB flash drive currently being used is indicated as a percentage.

⑤ [Document Name] Button

Press this button to open the [Document Name Setting] screen. Use this button to name a document.

⑥ [Destination Folder]

The name of the destination folder selected on the list screen is displayed here.

■ View Screen in [USB] - [Load]

Icon display

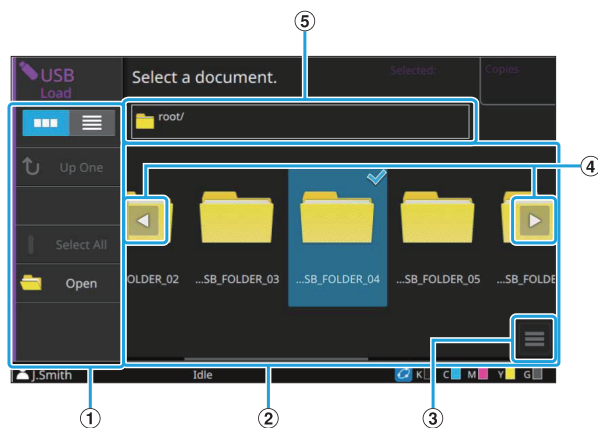

List display

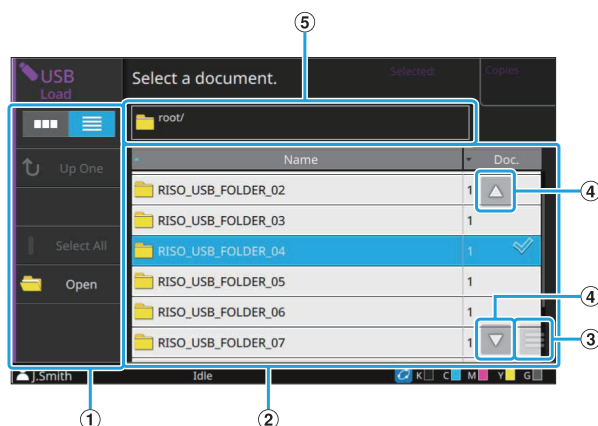

① Function Buttons

Select a function that can be used in USB mode.

② View

The folders and documents saved on a USB flash drive are displayed in a list.

③ Sub Menu

The following settings are available for selected documents:

- Details
- Change Setting
- Copy to Folder

④ ◀/▶/▲/▼ Buttons

Use these buttons to scroll through the list.

⑤ Folder Path Display

Displays the full path for the location of the selected folder within the USB flash drive.



- In the list display, you can touch one of the titles to sort the items on the list. The list can be sorted in the ascending or descending order based on the folder name or number of documents.

■ Change Setting Screen in [USB] - [Load]

This screen appears when you touch [Change Setting] in the sub menu on the document list screen.



- When using the optional PS kit, select a PDF file and touch [Print Setting].

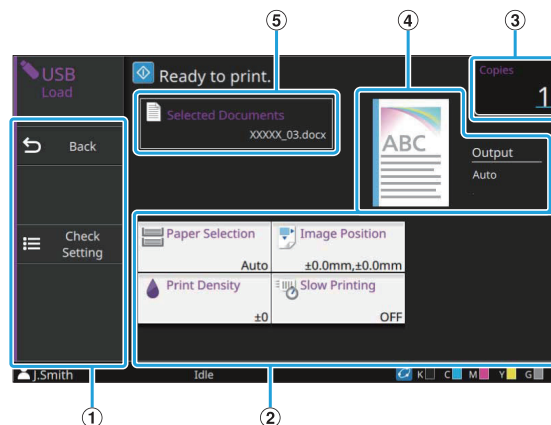

① Function Buttons

Select a function that can be used in USB mode.

② Setting Buttons

Use these buttons to set up USB Load functions. When you select a PDF file, touching the [More Menu] button will bring up other setting buttons.

③ [Copies]

Enter or check the number of copies to print.

④ Finishing Image

The setting details can be confirmed with the icons that are displayed.

⑤ [Selected Documents]

The name of the selected document is displayed here.

[External System Link] Screen

When using an external system link, you can operate documents saved on an external system. The screen displayed on this machine vary according to the external system you use. The following explanation is an example when you link with the external system using the MPS software.

■ Documents screen

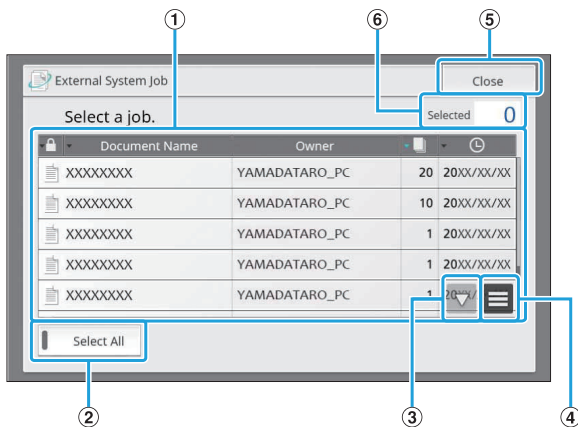

① Documents Display

The documents that can be used are displayed.



- You can touch one of the titles to sort the items on the list. The list can be sorted in the ascending or descending order based on the document name, name of the owner, number of pages, or date and time of save.

② [Select All] Button

Touch this to select all documents displayed in the list of documents.

③ ▲/▼ Buttons

Use these buttons to scroll through the list.

④ Sub Menu

Deletes the selected documents or displays the detailed information and the total amount of the selected documents.

⑤ [Close] Button

Closes the screen and disconnects the connection with external systems.

⑥ [Selected]

The number of selected documents is displayed here.



- Depending on the settings of the administrator, the [External System Link] button may be hidden or displayed with a different name. Contact your administrator for details.

[Admin Menu] Screen

This screen is only displayed when you are logged in as an administrator. You can access the settings that an administrator can use and modify. For more information, see the "Administrator's Guide".

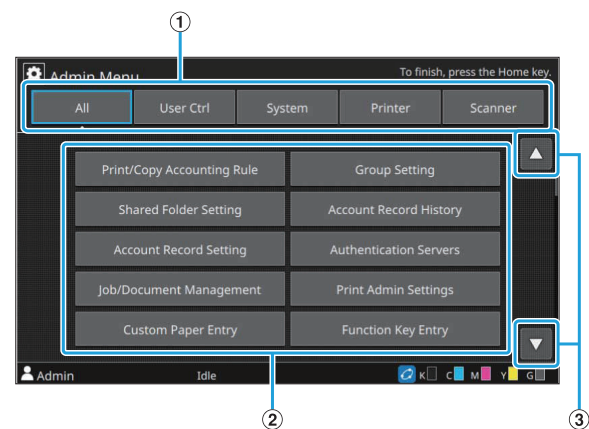

① Category Selection Buttons

The categories of administrator menu setting buttons are displayed here.

Touch [All] to show all setting buttons in the administrator menu.

② Setting Buttons

Use these buttons to set up the administrator menu functions.

③ ▲/▼ Buttons

Use these buttons to scroll through the list.

[Maintenance] Screen

[Print Head Cleaning], [Front Cover Release] and other functions are available on this screen. For more information, see "Maintenance" (p.240) in the "Appendix".

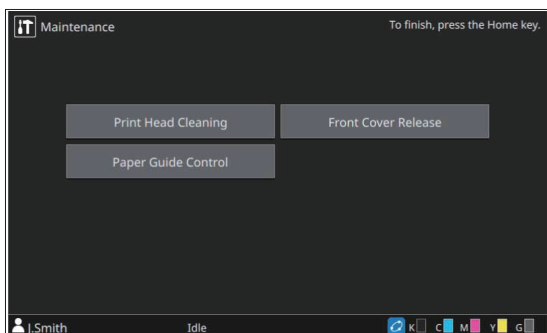

[System Info] Screen

■ Consumables Screen

This screen displays the status of consumables, such as paper and ink. You can also change the tray settings.

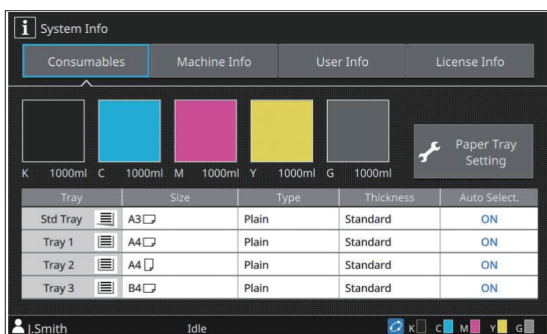

■ Machine Info Screen

This screen displays information about this machine.

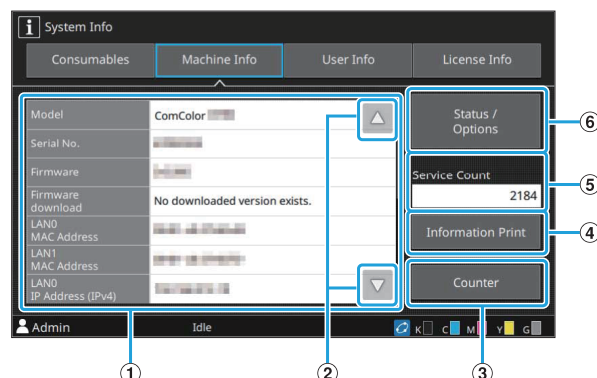

① Machine Info List

You can check the machine information such as the IP address and the firmware version.

② ▲/▼ Buttons

Use these buttons to scroll through the list.

③ [Counter] Button

The detailed count for each paper size is displayed.

④ [Information Print] Button

Touch this button to print the system information or a sample image.

⑤ [Service Count]

The total number of times of paper transport when printing and copying is displayed.

The number of times of paper transport is counted as 2 times per sheet when duplex printing is performed.

⑥ [Status / Options] Button

Touch this button to display information on the connected optional equipment and its status.

■ User Info Screen

This screen displays the user name and groups of the user logged in.

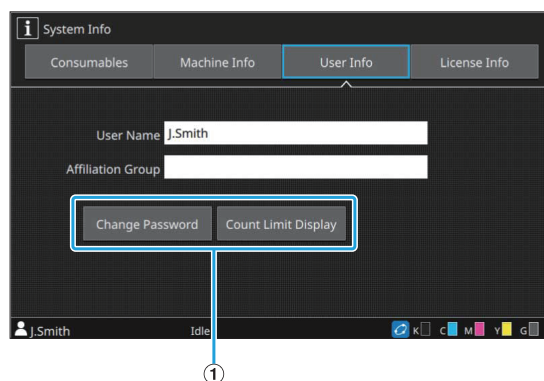

① Information Buttons

You can display the usage status of the user.
Touch [Change Password] to change the password.
If a copy or print limit is set by an administrator, touch [Count Limit Display] to view the usage status.
If you are using an IC card reader, touch [IC Card Regist.] to register the card information for users logged in.



- If you are using an external system link, the following buttons are also displayed:
 - [View Balance]: You can check the balance of each user who is logged in.

For more information on the billing system using the [External System Link] function, contact your dealer or authorized service representative.

■ License Info Screen

This screen displays the license information of the system used with this product.

Touch Panel

You can operate the machine by using the touch panel and keys on the operation panel. You can touch buttons displayed on the screen to select items, switch between screens by flicking your finger on the touch panel, or scroll through lists by swiping your finger.

Switching Screens

You can switch between the [Home1] screen and [Home2] screen by flicking the screen to the left or right. For more information, see "[Home1] Screen" (p.32) and "[Home2] Screen" (p.33).

Scrolling

You can scroll through the screen on which setting items are displayed or through lists of folders and documents by flicking the screen to the left/right or top/bottom. Touch the screen to stop the scrolling. You can also scroll through scrollable screens and lists with the drag operation by sliding your finger to the left/right or top/bottom without lifting your finger from the touch panel. Remove your finger from the touch panel to stop the scrolling.

Selecting a Button

To select a button on the touch panel, touch the button with your finger.
Either a part of or the entire selected button will turn blue.

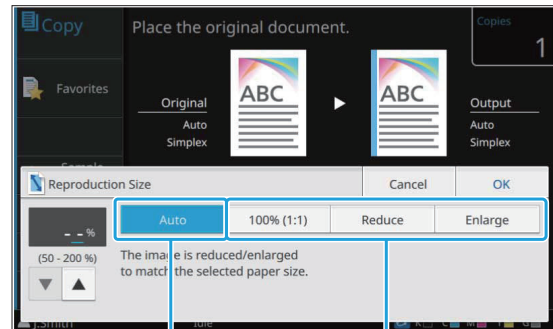

Selected button Buttons not selected

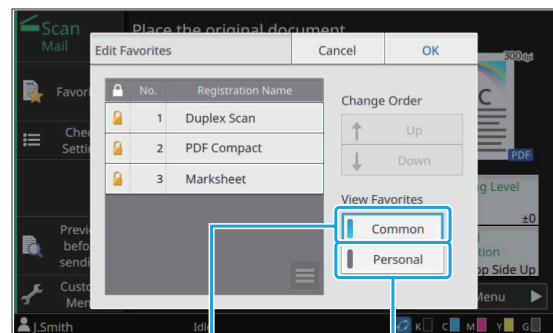

Selected Not selected

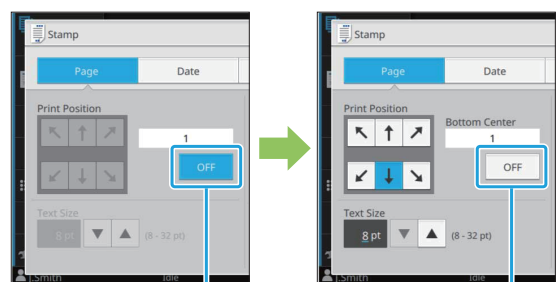

Selected Not selected

Buttons that are not available under the current conditions are grayed out.
You can use these buttons when the required conditions are met.

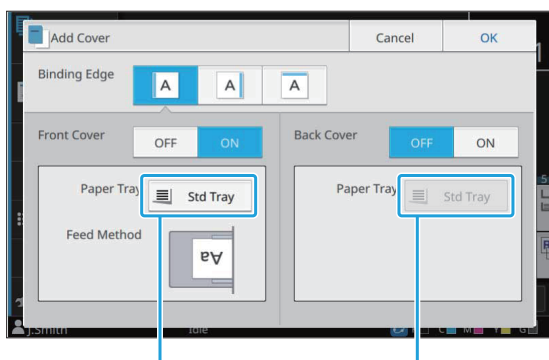

This option is available because [Front Cover] is set to [ON].

This option is not available because [Back Cover] is set to [OFF].

Confirming / Canceling a Setting

When [OK] is displayed on a screen, you must touch [OK] to save the settings. If you do not touch [OK], the settings may be canceled. To cancel the settings you have edited, touch [Cancel].

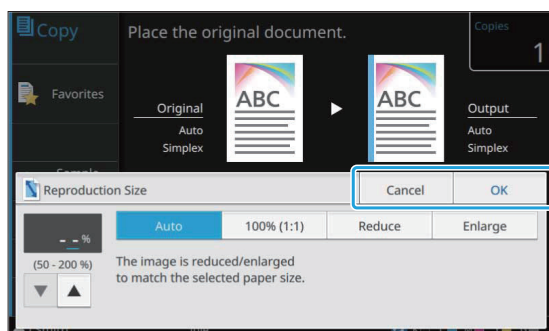

Colors of Setting Buttons

When a setting is changed, the setting button turns color to indicate that the setting has been changed from the default value.



Entering Text

When entering user names or passwords, enter the required information on the text input screen.

1 Touch the characters you want to enter one by one.

To move the cursor, touch [←] or [→].

Touch [✕] if you need to erase a character to the left of the cursor.



- If the available characters are restricted, as is the case with passwords, the characters that cannot be used are grayed out.
- To enter an uppercase letter, touch [Shift] first, and enter the character. To return to the lowercase letter input, touch [Shift] again.
- The maximum number of characters that can be entered and the current number of characters entered are displayed to the right of the text input field.

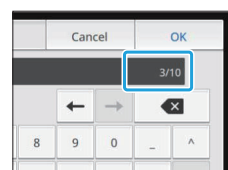

2 After entering the text, touch [OK].



- Depending on the entry area, touching the area may not open up an entry screen. In such cases, use the numeric keys.
- The current selected area is indicated by a flashing short line under numbers or letters. To switch the area, touch the area that you want to enter text in.

Preparation

This chapter explains how to turn on the power, log in, load the paper, and do other preparations to make this machine ready for use.



- When using the feed tray, you do not need to set the standard tray.
- With the RISO Console, you can check the status of the machine on your computer. (p.156 "Overview of the RISO Console")

Power

The machine has two power switches, the main power switch and the [Power] key. Use the main power switch to turn on the main power to the whole machine.

Press the [Power] key to start this machine.



- To turn off the power to this machine in normal use, press and hold the [Power] key on the operation panel.
- Do not turn off the main power except when the machine is not going to be used for an extended period of time or when the power supply is unintentionally stopped due to lightning strike or other unexpected causes.

Turning On the Power

- 1 Make sure that the power plug is inserted into an electrical outlet.**
- 2 Turn on the main power switch.**
The [Main Power] LED on the operation panel turns on.
- 3 Press the [Power] key on the operation panel.**
The power turns on and the [Power] key lights up.

Turning Off the Power

- 1 Press and hold the [Power] key on the operation panel.**
- 2 Check that the [Power] key is off, then turn off the main power switch.**
The [Main Power] LED turns off.



- To turn on the main power again, first make sure that the [Main Power] LED is off.
- Remove the power plug only after turning off the main power switch.

Power-saving Features

If you leave the machine unattended for some time, it automatically goes to power saving mode. The power saving mode has two states, the backlight off state and the sleep state. The respective transition times and power consumption in sleep are set by the administrator. When the power saving mode turns on, the touch panel turns off, and the [Wake Up] key turns on. When you press the [Wake Up] key, the power saving mode is canceled, and the machine returns to normal operating mode. The machine takes longer to recover from the sleep state than from the backlight off state.

Login

Lock icons in the upper right corner of mode buttons indicate that you must log in to access those modes.

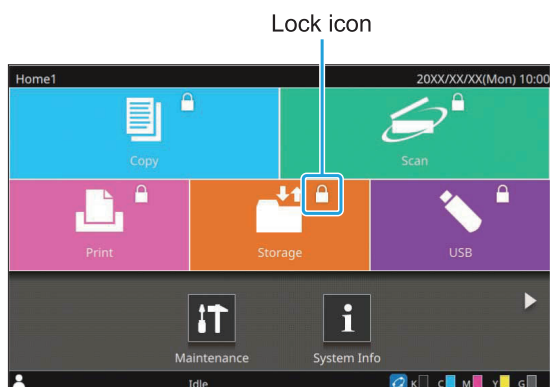

- When logging in for the first time, you need the temporary password that is issued by the administrator.

Logging In



- When using an IC card reader, you can log in by holding the IC card over the card reader.

- 1 Press the [Login/Logout] key.
- 2 On the [Login] screen, select your name.
To find your name, scroll through the screen or press the index button to display user names. The [Password] screen appears after you select your name.
- 3 Input your password and touch [Login].

Follow the displayed instructions for operation.



- When logging in for the first time, change the temporary password to your own password.

When you are successfully logged in, the screen you were in when you pressed the [Login/Logout] key appears again. Your user name is displayed at the bottom left of the screen.



- After finishing operations, be sure to press the [Login/Logout] key to log out.



- Contact your administrator if you cannot find your name, or if you have forgotten the password.
- If your user name does not appear at the bottom left of the [Home1] screen, touch the mode button and perform the operations described in steps 2 and 3 under "Logging In". When you are successfully logged in, the screen for the selected mode appears.

Changing the Login Password

- 1 Touch [System Info] on the [Home1] screen after logging in.
- 2 Touch [User Info] - [Change Password].
- 3 Enter the new password and touch [Next].
- 4 On the [Change Password (confirm)] screen, enter the new password again and touch [OK].

Loading the Paper

Load the paper in the feed trays and the standard tray.



- We recommend loading the feed trays with types of paper you will use most often.
 - Use the standard tray for the following types of paper:
 - Thick paper and other special paper
 - Preprinted paper
 - Postcards
 - Envelopes
- For more information, see "Printing Paper" (p.24).
- For more information on how to load paper when using the optional additional tray or high capacity feeder, see the following:
 - When using the additional tray (p.185 "Loading the Paper")
 - When using the high capacity feeder (p.188 "Loading the Paper")

Loading the Paper in the Feed Trays

- 1 Pull a tray out, toward the front.**

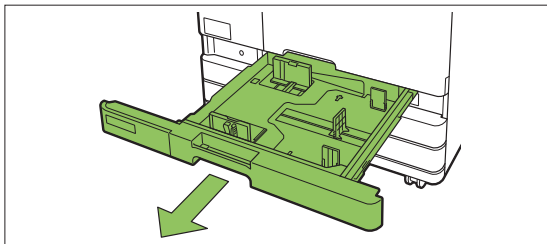

- 2 Hold the lever of the paper feed guide, and pull it forward to spread the paper feed guide until it stops.**

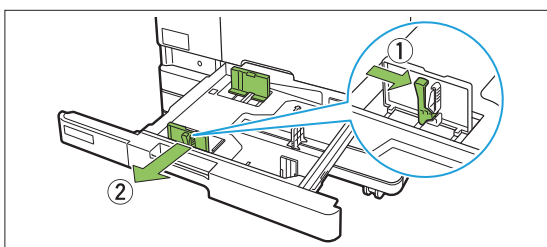

- 3 Move the stopper to make space.**

Move the stopper by holding both sides.

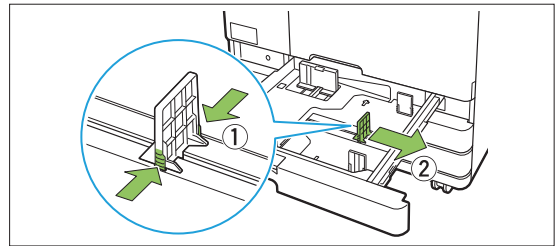

- 4 Load the paper.**

When using paper with different characteristics on the front and back sides, load the printing side face down. Do not load too many sheets.

When loading the paper, be careful not to let its edge contact the paper guides to prevent it from being bent.

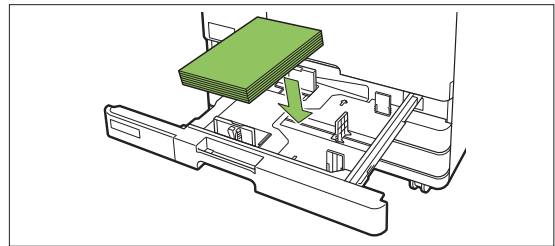

- 5 Move the paper feed guide and stopper against the edge of the paper.**

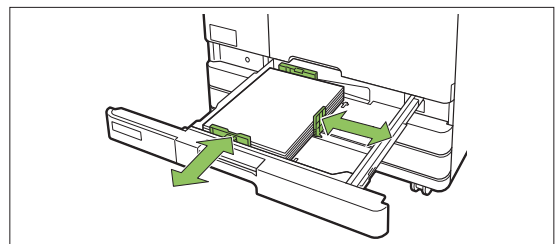



- The machine detects the size of the paper based on the stopper position. Be sure to move the guides against the edge of the paper.
- To set A3 paper or B4 paper, install the A3/B4 paper guide properly for each type. Pinch both sides of the A3/B4 paper guide, slide it out and then slide it into the appropriate hole for the desired paper size.

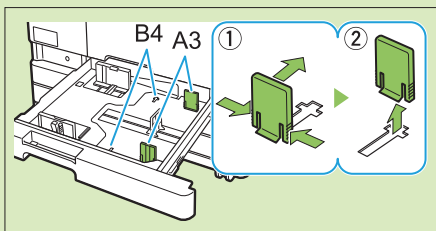

When using A3 paper

6 Push the tray back into the machine.

7 On the operation panel, check the tray settings.

When you have switched to a different type or size of paper, update the feed tray settings. (p.61 "Paper Selection")

Loading the Paper in the Standard Tray

1 Open the standard tray until it stops.

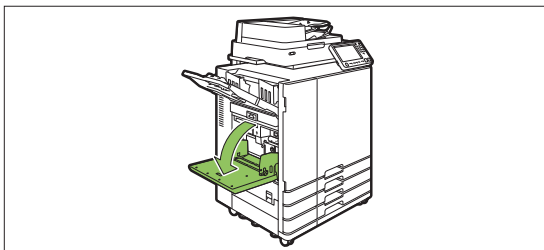

2 Spread the guides.

Raise the paper feed guide levers (both sides) to unlock and slide the guides.

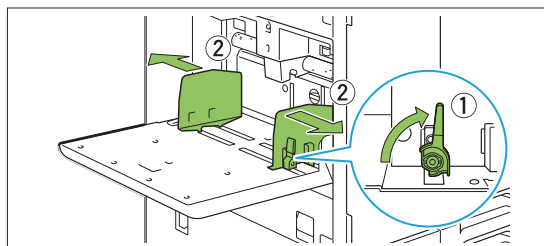

3 Load the paper.

Load the paper with the printing side face up.

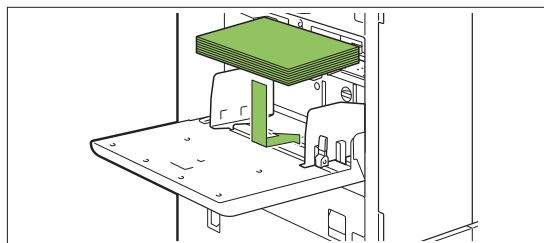

- When printing on envelopes, it is recommended that you connect the optional stacking tray and envelope feed kit.
- Be sure to load envelopes with their flaps open and their bottom side entering the machine first.

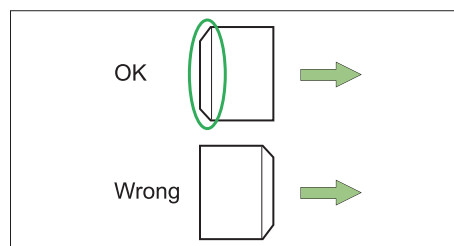

- The [Rotation] feature is useful for printing on envelopes from a computer.

4 Adjust the paper guides so that they are suitable for the paper size.

Move the guides against the edges of the paper, and push the lever to lock.

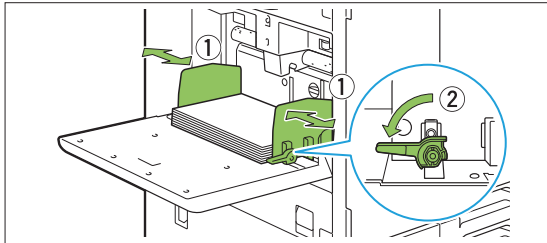

- The machine detects the paper size at the guide position. Be sure to move the guides against the edge of the paper.
- Do not place spare paper on the paper size detection sensor when loading A4, Letter, or A5 size paper. If the sensor is blocked, the machine cannot detect the paper size correctly.

5 Adjust the paper feed pressure adjustment lever.

For general use, set to "✖ (NORMAL)". For drawing paper, postcards, and similar products, set to "≡ (CARD)".

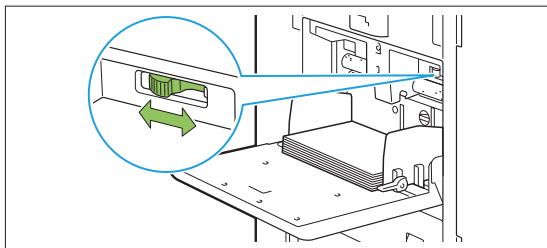

- For envelopes, set to "≡ (CARD)" according to their thickness (paper weight).

6 On the operation panel, check the tray settings.

When you have switched to a different type or size of paper, update the feed tray settings. (p.61 "Paper Selection")

Adding or Switching the Paper in the Standard Tray

Press the standard tray descent button when loading additional sheets or when switching paper. Note that the standard tray is automatically lowered when all paper is removed.

1 Press the standard tray descent button to lower the standard tray.

Hold the button down until the tray reaches the desired position.

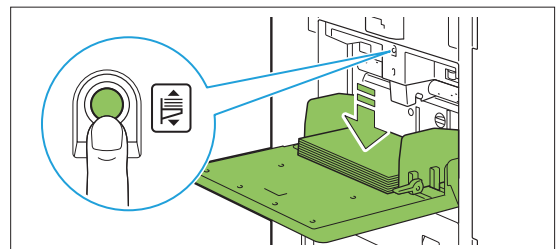

2 Load additional paper, or switch the loaded paper.

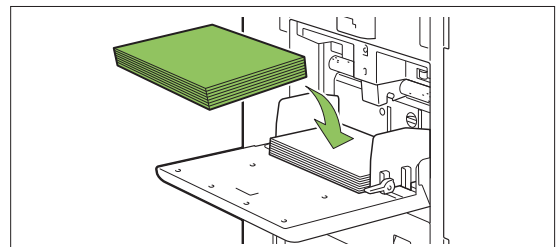

3 Adjust the paper feed pressure adjustment lever.

When the paper with different thickness is reloaded, you need to adjust the paper feed pressure adjustment lever accordingly. For general use, set to "✖ (NORMAL)". For drawing paper, postcards, and similar products, set to "≡ (CARD)".

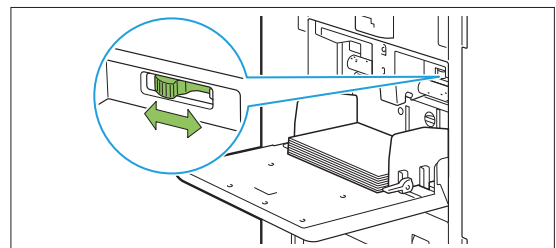



- For envelopes, set to "✕ (CARD)" according to their thickness (paper weight).

4 On the operation panel, check the tray settings.

When you have switched to a different type or size of paper, update the feed tray settings. (p.61 "Paper Selection")

Closing the Standard Tray



- Make sure that the power is on when you perform this operation.

1 Remove the loaded paper.

The standard tray starts lowering.

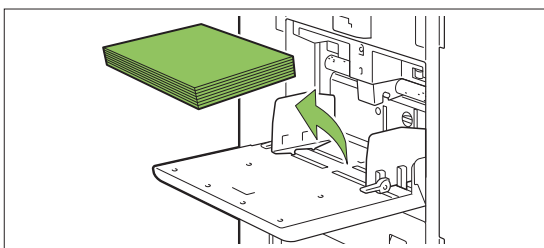

2 Close the standard tray.



- Make sure the standard tray is all the way down before closing it.

Installing and Uninstalling the Printer Driver

If you want to send data from a computer to print on this machine, you must first install the printer driver onto the computer.



- Log in as a user with administrator privilege.
- Close all active applications.
- Use the uninstaller to uninstall the application. For more information, see the "Administrator's Guide".
- If you are using Mac OS or Linux, install the optional PS kit. For more information on how to install the PostScript printer driver, see "PS Kit" (p.218) in "Optional Equipment".
- For US customers

Selecting "English" as the preferred language and "inch" as the unit of length will apply inch size paper [LETTER size] as a default setting. The default paper size can be altered after finishing of installation.

Operating Environment

The recommended system requirements for activating the printer driver are described in the table below:

Memory	8GB or more
CPU	Core i5-8400 2.8GHz or higher grade
Display	1024 × 768 or greater resolution

Installing



- To update the printer driver, uninstall the current printer driver before updating. (p.51 "Uninstalling")

1 Load the included DVD-ROM in the computer's DVD-ROM drive.

The installation wizard automatically starts up. If the installation wizard does not start up, double-click the "Install.exe" file on the DVD-ROM.

2 Select the series of your printer in the pull-down menu and click [OK].

3 Select the desired language in the pull-down menu and click [OK].

4 Click [Next].

5 Follow the on-screen instructions to configure the settings.



- [Duplex / Simplex] is set to [Duplex (Long Edge)] as the default, which enables duplex printing. (p.108 "Duplex/Simplex")

6 When the message for printing a test page is displayed, click [Yes].

7 Confirm that the test page is printed correctly and click [OK].



- Pressing [Show "ReadMe" text.] displays the "Readme" screen that includes precautions for using the machine. Be sure to read this information.
- When a message that prompts you to update the status of the machine appears, click [OK] and set the printer configuration under the [Environment] tab after installation. When you added an optional equipment to the machine, you also need to set the printer configuration. When optional equipment is connected, first configure the settings to use certain functions. The unavailable functions are grayed out. (p.127 "[Environment] Tab")

8 Click [Finish].

If the printer driver is installed over the existing one, the computer restarts.



- If you do not want to restart the computer now, remove the check mark from the [Restart now] check box before clicking [Finish].

9 Remove the DVD-ROM from the computer.



- Keep the DVD-ROM in a safe place for future reference.

Uninstalling

■ For Windows 10 and Windows Server 2019

Click [Start] - [RISO ComColor-GL] - [Uninstaller]. Follow the displayed instructions for uninstallation.

After the printer driver has been uninstalled, restart the computer.

■ For Windows 8.1, Windows Server 2012, and Windows Server 2012 R2

Open the [Apps] screen and click [RISO ComColor-GL] - [Uninstaller]. Follow the displayed instructions for uninstallation.

After the printer driver has been uninstalled, restart the computer.

About Jobs

This section describes how to use [Details], [Print], [Delete], and other functions available from the Document List of each screen. You can press the [Job Status] key to check jobs that are in progress or finished.



- A job is the unit of tasks performed by this machine in each mode (e.g., Print mode, Copy mode).
- In the following cases, the job name is displayed as "*****":
 - Jobs with the [Hide Job Name] check box selected on the printer driver (p.125 "PIN Code")

[Active / Idle] Screen

Touching [Active / Idle] displays a list of jobs in progress and jobs waiting to be printed. Jobs are printed in order from the top of the list.

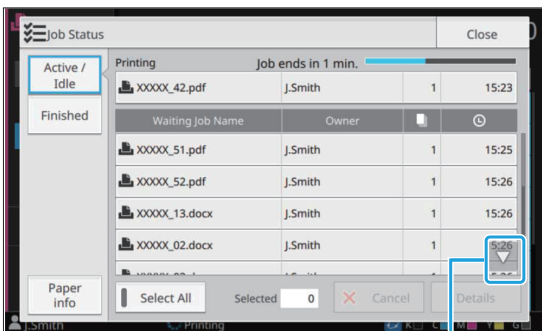

- Output order (order of job priority) under [Active / Idle]
When interrupt copy is performed on the machine, the interrupt copy job has priority over jobs sent from the printer driver.

Job List

The job list displays the job name, status, owner name, number of copies (☐), and receiving time (🕒) for jobs that are being printed, in processing, and waiting to be printed.

An icon indicating the job type is displayed on the left side of the job name.

Icon	Job Type
	Copy job
	Print job
	Storage (Load) job
	USB (Load) job
	PS job (when using the optional PS kit)
	Job with a PIN code
	Broken job



- ▲/▼ can be touched to scroll through the list.
- Touch [Select All] to select all jobs in the list.

Checking the Current Status of a Job

The current status of the job being printed and processed is displayed with a progress bar. The expected finish time is also displayed for the jobs currently printed.



- If the [Mixed Size Original] function is used or when the number of pages of the print job is unknown, the expected finish time will not be displayed.

Canceling a Job

To cancel a job, select the job that you want to cancel and either touch [Cancel] or press the [Stop] key. To cancel a job with a PIN code, you need to enter the PIN code.



Checking the Details of a Job





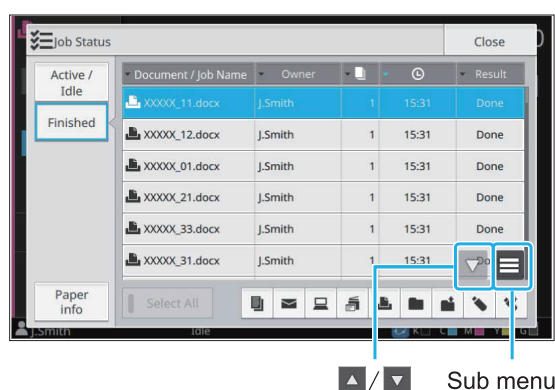







Touch [Details] to view the details of a job in progress or waiting to be printed.

[Finished] Screen

Touch [Finished] to display a list of completed jobs.



You can check the document/job name, owner name, number of printed copies (), print date/time (), and processing result. An icon indicating the job type is displayed on the left side of the job name.

Icon	Job Type
	Copy job
	Print job
	Scan (Mail) job
	Scan (PC) job
	Scan (Console) job
	Storage (Save) job
	Storage (Load) job
	USB (Save) job
	USB (Load) job
	PS job (when using the optional PS kit)
	Job with a PIN code
	Broken job



- Touch the sub menu to check the details of a job, print the job again, or delete the job.
- ▲ / ▼ can be touched to scroll through the list.

- Touch categories such as [Document / Job Name] or [Owner] to switch the sorting order between ascending and descending for display.
- Touch [Select All] to select all jobs in the list.
- Touch the button of the icon below the list to display only the selected types of jobs. All jobs will be displayed when no buttons are selected.
- This list also displays a history of processed jobs. The job type, save period, and number of jobs displayed in the list are specified by the administrator. Contact your administrator for details.

[Paper info] Screen

Touch [Paper info] to display the tray which is feeding paper. When you want to add paper during printing with the machine, check the available tray on this screen.

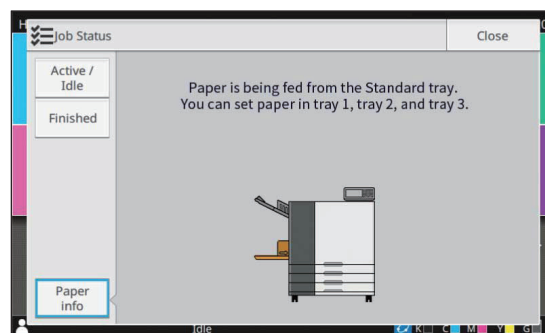

Copying

Use the scanner to scan and make a copy of a paper original.

You can make copies in various ways by such as printing on both sides or fitting multiple pages onto a single sheet to suit your different needs.

Overview of Copy Operations

p.56

1. Load the original.



2. Touch [Copy] on the [Home1] screen.



3. Change the settings.



4. Specify the number of copies using the numeric keys.



5. Press the [Start] key.

Copy Settings

p.61

This section explains each copy setting in detail.

Copy Mode Function Buttons

p.81

This section explains the functions available in the copy mode.

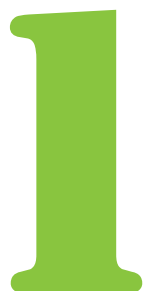

1



Copying

Overview of Copy Operations

This section explains the basic copy operations.

Procedure

1 Load the original.

For more information on the types of originals that can be used, see "Originals" (p.22).

■ In the ADF

1) Load the original in the ADF.

Align the originals and place them face up.

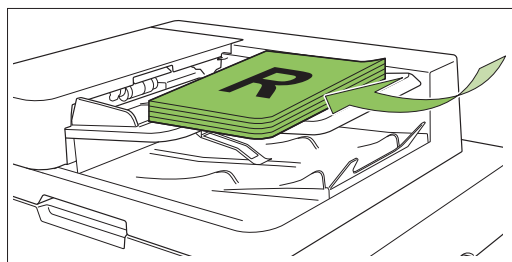

2) Slide the original guides to match the width of the originals.

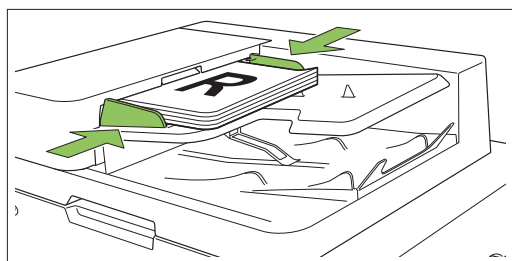

■ On the Platen Glass

1) Open the original cover.

2) Load the originals.

Load the original face down on the glass. Align the corner of the original with the upper-left corner of the glass.

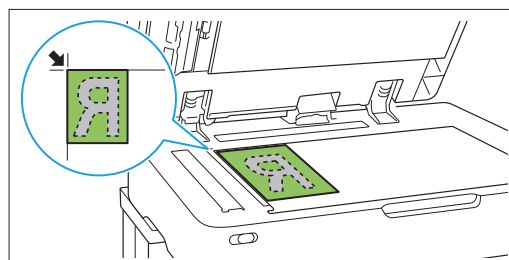

3) Close the original cover.



• Open and close the original cover gently.

2 Touch [Copy] on the [Home1] screen.

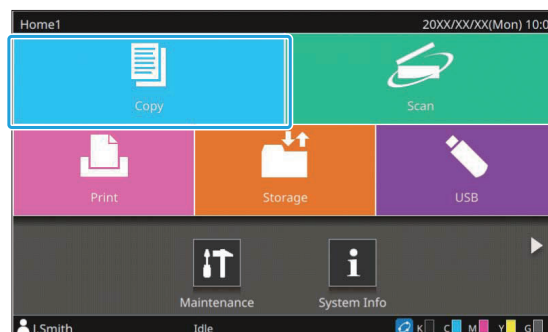

3 Change the settings.

Specify the detailed settings for copying. For more information on the functions that can be configured, see "List of Settings" (p.59).

4 Specify the number of copies using the numeric keys.

Enter the desired number of copies, up to a maximum of 9,999.

5 Press the [Start] key.

The [Copying] screen is displayed, and copying of the original starts. The current status is displayed on the screen.



- When you touch [Slow Printing] and select the check box, the printing speed will slow down. This also reduces the amount of noise produced by the machine when printing jobs.
- When you need to copy a document while a job is being printed, press the [Interrupt] key to pause the current job, and start another copy job.

■ When using the platen glass to scan an original with several pages

After scanning one page of an original, a screen with a message asking whether there is another page to be scanned appears.

When there is another page to be scanned, load the next page and touch [Scan]. After all pages of the original are scanned, touch [Scanned].



- The confirmation screen above is displayed when [Sort] is set to [Collated]. (p.64 "Sort")

Loading the Next Copy Job

During copying, once scanning of the original has been completed, you can begin scanning the next original.

1 Press [Close] on the [Copying] screen.

2 Load the next original and press the [Start] key.

A message appears, and the original is copied as the next job.

Canceling Copying

1 Press the [Stop] key.

The [Suspending] screen is displayed.

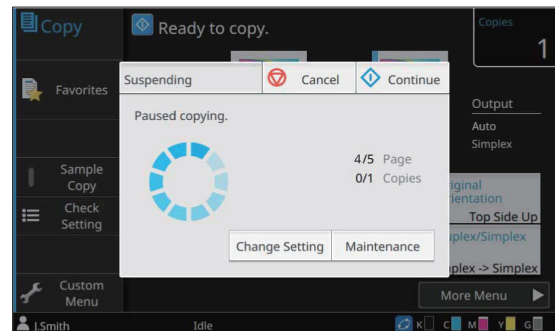

2 Touch [Cancel].

The [Confirm] screen is displayed.

3 Touch [OK].

Copying is canceled.

4 Touch [Close].

Changing Settings During Copying

1 Press the [Stop] key.

The [Suspending] screen is displayed.

2 Touch [Change Setting].

The [Change Setting] screen is displayed.

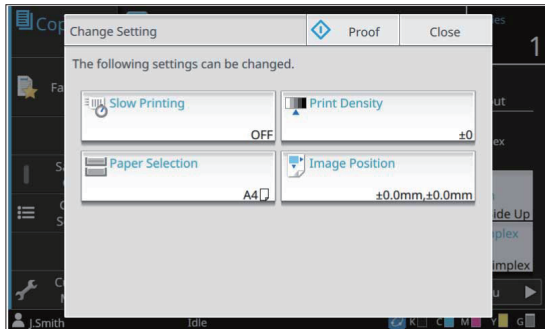

3 Change Settings.

You can change the following settings:

- Slow Printing (p.79 "Slow Printing")
- Print Density (p.65 "Print Density")
- Paper Selection (p.61 "Paper Selection")
- Image Position (p.73 "Image Position")



- If you touch [Proof], only one copy of the page that was being processed when the [Stop] key is pressed is output.

4 Touch [Close].

5 Touch [Continue].

The copy job is resumed with the changed settings applied.

Performing Maintenance During Copying

1 Press the [Stop] key.

The [Suspending] screen is displayed.

2 Touch [Maintenance].

The [Maintenance] screen is displayed.

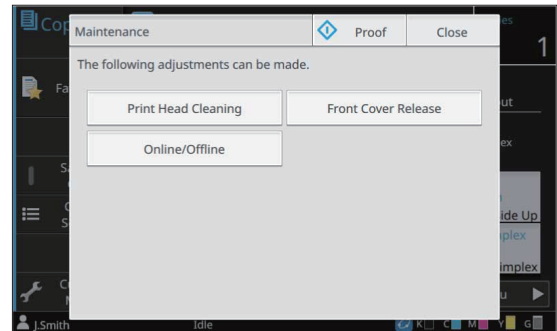

3 Make the necessary adjustments.

The following maintenance options are available:

- Print Head Cleaning
- Front Cover Release
- Online/Offline
- Paper Guide Control



- Touch [Online/Offline] to display the [Online/Offline] screen.
When this setting is set to [OFF], the machine will not receive jobs from network devices such as computers. This option is convenient when you want to use the machine exclusively without being interrupted by other job.
- For more information on [Print Head Cleaning] and [Front Cover Release], see "Maintenance" (p.240) in the "Appendix".
- If you touch [Proof], only one copy of the page that was being processed when the [Stop] key is pressed is output.
- If you are using the optional auto-control stacking tray or high capacity stacker, you can adjust the position of the stacking tray with [Paper Guide Control].
For more information, see "Maintenance" (p.240) in the "Appendix".

4 Touch [Close].

5 Touch [Continue].

The copy job is resumed with the adjustment applied.

List of Settings

The following is a list of settings available in Copy mode.



- There are items that are displayed only when you are using the optional face down finisher, stacking tray, or multifunction finisher. In such case, the display and functions may differ depending on the optional equipment that is connected.

Setting item	Use this item to:	See
Color Mode	Select color or monochrome printing.	p.61
Reproduction Size	Reduce or enlarge the copied image.	p.61
Paper Selection	Change the paper tray, paper type, and feed control settings according to the copying paper.	p.61
Scanning Size	Specify the scanning size for originals.	p.63
Original Orientation	Specify the orientation of the original.	p.64
Duplex/Simplex	Specify the sides of the original to be scanned and the sides of the paper to be printed on.	p.64
Sort	Specify the printing method for making multiple copies of the original.	p.64
Scanning Level	Adjust the scanning level of originals.	p.65
Print Density	Specify the print density.	p.65
ADF Scan & Pause	Copy the original as one job even when having to load the original in multiple sets due to the large number of pages in the original.	p.65
Mixed Size Original	Copy the original containing pages of the different original sizes.	p.65
Book Shadow Erasure	Remove shadows that appear in the center of images when an open book is scanned.	p.66
Page Split	Scan double-spread pages and split them into two parts (right and left).	p.67
Combine	Impose continuous pages onto one sheet.	p.68
Image Repeat	Impose multiple copies of the same original onto one sheet.	p.68
Booklet	Specify the imposition setting when creating a booklet. You can also bi-fold the pages and bind them in the center when the optional multifunction finisher is connected.	p.68
Stamp	Stamp the page number, date, or text in the header or footer.	p.69
Page Border	This option adds a border line in the margins of the paper.	p.71
Image Quality	Specify the resolution for scanning originals.	p.71
Original Type	Select the original type so that the appropriate image processing is performed before printing the scanned data.	p.71
Gamma Correction	Adjust the color balance (CMYK) of the scanned data.	p.72
Image Control	Specify the image processing appropriate for the original.	p.72
Base Color Level	Make the background color (base color) lighter so that the text is easier to read.	p.72
Image Position	Adjust the print position.	p.73
Overlay	Make copies upon layering an image that has been saved on the storage.	p.73

Setting item	Use this item to:	See
Program	Specify the number of copies by group (such as corporate division or class). You can quickly print exactly the number of copies of the number of sets you need.	p.74
Add Cover	Add front and back covers to the printout.	p.77
Separation	Insert slip sheets. When the optional face down finisher, high capacity stacker, or multifunction finisher is connected, the offset output setting is also available.	p.77
Binding Margin	Print with a binding margin for the pages. Specify the binding edge and the value for the binding margin.	p.78
Staple / Punch	Specify the stapling position.	
	When using the optional face down finisher	p.184
	When using the optional multifunction finisher	p.214
	Specify the punch position. (When using the optional multifunction finisher with the punch unit)	p.214
Fold	Configure the paper folding settings. (When using the optional multifunction finisher with the folder unit)	p.215
Slow Printing	Decrease the printing speed. This also reduces the amount of noise produced by the machine when printing jobs.	p.79
Output Tray	Select the output tray for printouts.	
	When using the optional auto-control stacking tray / wide stacking tray	p.194
	When using the optional high capacity stacker	p.201
	When using the optional multifunction finisher	p.217
Face Up/Down	Specify whether to stack the pages face up or face down in the stacker.	
	When using the optional auto-control stacking tray / wide stacking tray	p.194
	When using the optional high capacity stacker	p.201
	When using the optional multifunction finisher	p.217
Output Tray Relay	Switch the output tray automatically when the output tray becomes full.	
	When using the optional auto-control stacking tray	p.194
	When using the optional high capacity stacker	p.201
	When using the optional multifunction finisher	p.217
Paper Tray Relay	Feed paper automatically from a different tray with the same paper size and paper type when the selected tray runs out of paper.	p.79
Auto Image Rotation	Rotate the image 90 degrees automatically when the orientation of the original and paper do not match.	p.79
Scan Job Build	You can collectively copy multiple originals scanned with different settings as one job.	p.80
Interrupt Copy	Pause the job being printed to copy another document.	p.80
Favorites	Call frequently used settings.	p.81
Additional Copy	Make additional copies of the original that was just copied without re-scanning.	p.81
Sample Copy	Make one copy and stop copying to check the printing result before making a large number of copies.	p.81
Check Setting	Check the current settings.	p.82
Custom Menu	Register favorites and default settings, and edit the button order.	p.82

Copy Settings

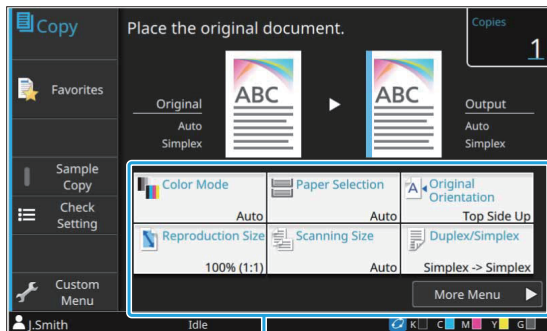

Setting buttons

Color Mode

Select color or monochrome printing.

[Auto]

Select this option if you want the machine to automatically detect the color of the original and copy in color (cyan, magenta, yellow, gray, and black) or black and white.

[Full Color]

Select this option to copy by converting the original data to five-color data (using cyan, magenta, yellow, gray, and black).

[Black]

Select this option to copy in one color (black) regardless of the color of the original.

[Cyan]

Select this option to copy in one color (cyan) regardless of the color of the original.

[Magenta]

Select this option to copy in one color (magenta) regardless of the color of the original.

1 Touch [Color Mode].

The [Color Mode] screen is displayed.

2 Select the color mode.

3 Touch [OK].

Reproduction Size

Copy at the specified reproduction size.

[100% (1:1)]

Select this option to copy at 100%.

[Auto]

The reproduction size is set automatically based on the original size and paper size. (p.61 "Paper Selection")

[Reduce]

Select this option to copy by reducing a standard size original to fit another standard size paper.

[Enlarge]

Select this option to copy by enlarging a standard size original to fit another standard size paper.

Manual

Specify the reproduction size to enlarge or reduce the original when copying.

1 Touch [Reproduction Size].

The [Reproduction Size] screen is displayed.

2 Specify the reproduction size.

To use a user-defined reproduction size, touch [▼] or [▲] to specify the size. You can also enter the number using the numeric keys.

3 Touch [OK].

Paper Selection

Select a paper tray.

You can also change the tray settings (paper size, paper type, double-feed check, and auto selection).

[Auto]

Select this option if you want the paper tray to be automatically selected from the tray selection.

Paper tray selection

When using a paper size that is different from the original size, or to use a tray with [Auto Selection] not set to [ON], select a paper tray.

[Paper Tray Setting]

Change the paper tray settings.

- 1 **Touch [Paper Selection].**
The [Paper Selection] screen is displayed.
- 2 **Select [Auto] or select a paper tray.**
- 3 **Touch [OK].**



• If you use the "Mixed Size Original" (p.65) option, [Paper Selection] will be set to [Auto].

Changing the Paper Tray Setting

Touch [Paper Tray Setting] to change the paper tray settings. When changing the paper loaded in a tray, be sure to change the paper tray settings.

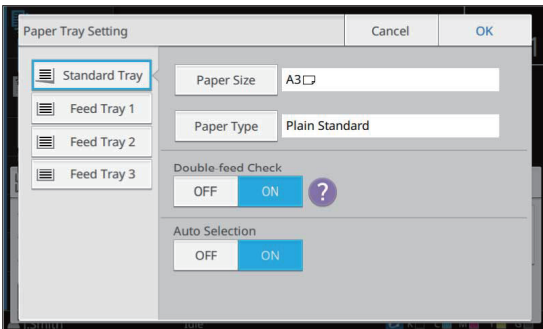

Paper tray selection

Select the paper tray for which you are going to change the settings.

[Paper Size]

Select the paper size.



• When the optional additional tray is selected, this setting is unavailable.

[Paper Type]

Select the paper type and thickness.

[Double-feed Check]

Select whether to check for the feeding of multiple sheets of paper. Normally, this setting is set to [ON]. This function uses light permeability to detect multiple sheets of paper, so when using paper printed on the back or paper with a dark base color or envelopes, select [OFF].

[Auto Selection]

Set this option to [ON] to make a paper tray available for automatic selection.

- 1 **Touch [Paper Tray Setting] on the [Paper Selection] screen.**
The [Paper Tray Setting] screen is displayed.
- 2 **Select the paper tray for which you are going to change the settings.**
- 3 **Touch [Paper Size].**
The [Paper Size] screen is displayed.
- 4 **Select a paper size and touch [OK].**
- 5 **Touch [Paper Type].**
The [Paper Type] screen is displayed.
- 6 **Select a paper type and touch [OK].**
- 7 **Configure [Double-feed Check].**
- 8 **Configure [Auto Selection].**
- 9 **Touch [OK].**



• It is recommended that trays that are loaded with special paper (high-quality paper, color paper, thick paper, paper with letterhead, etc.) should not be set to be available for auto selection.

■ **Paper Size**

[Auto]

Select this option if you want standard size originals to be detected automatically.

[Standard]

Specify the standard size.

[Custom]

Select this option to select from non-standard paper sizes registered by the administrator in advance.

[Manual]

Specify a non-standard paper size that is not registered.

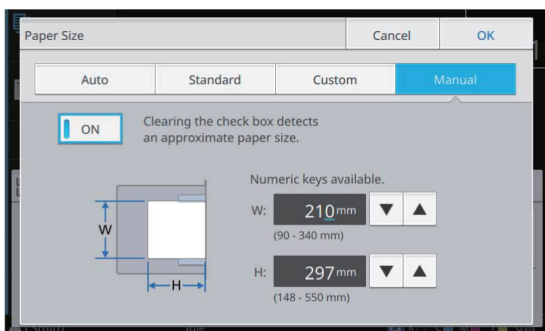

- When [ON] is not selected, the sheet width is set to the width of each paper tray guide. The maximum length of the relevant tray is used for the length.

■ Paper Type

[Type], [Thickness]

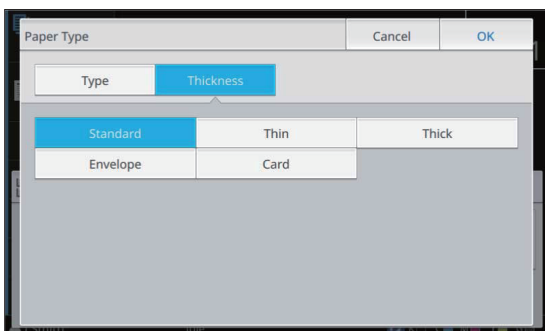
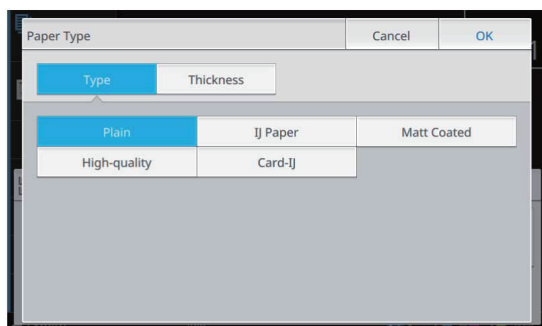

- If the thickness of the paper loaded in the standard tray is set to [Envelope], duplex printing cannot be performed from the standard tray.
- When the paper with different thickness is reloaded, you need to confirm the setting of the paper feed pressure adjustment lever. For more information, see "Adding or Switching the Paper in the Standard Tray" (p.48).

- When either of the following operations is performed with the standard tray, [Thickness] is automatically changed to [Envelope]:

- Selecting an envelope size in [Standard] of [Paper Size]
- Loading envelopes whose size can be detected in the standard tray when [Auto] is selected for [Paper Size]

After that, when either of the following operations is performed, [Thickness] returns to the original setting:

- Selecting a paper size other than envelopes in [Standard] of [Paper Size]
- Loading paper other than envelopes whose size can be detected in the standard tray when [Auto] is selected for [Paper Size]

- The machine selects the color profile according to the selected paper type. (When you change the paper type, the printing result changes.) If the printing result is not what you expected, change the paper type.
- When using special paper, you can add settings to [U1] through [U5] for [Thickness]. For more information, contact your dealer or authorized service representative.

Scanning Size

Specify the scanning size for originals.

[Auto]

Select this option if you want the scanning size of the original to be automatically detected.

[Standard]

Select this option when using a standard size different from that of the original.

[Custom]

Select this option to select from non-standard paper sizes registered by the administrator in advance.

[Manual]

Specify a non-standard paper size that is not registered.

1 Touch [Scanning Size].

The [Scanning Size] screen is displayed.

2 Specify the scanning size for originals.

To use a non-standard size that is not registered, touch [▼] or [▲] on the [Manual] screen to enter values.

You can also enter the number using the numeric keys.

3 Touch [OK].

Original Orientation

[Top Side Up]

Select this when loading the original with the top of the original facing toward the back of the platen glass or the ADF.

[Top Side Left]

Select this when loading the original with the top of the original facing toward the left of the platen glass or the ADF (so that the text of the original is sideways).

1 Touch [Original Orientation].
The [Original Orientation] screen is displayed.

2 Select the original orientation.

3 Touch [OK].

Duplex/Simplex

Specify the combination of the sides of the original to be scanned and the sides of the paper to be printed on.

[Simplex -> Simplex]

One side of the original is scanned and printed on a single side of paper.

[Simplex -> Duplex]

One side of the original is scanned. The scanned data is then printed on both sides of paper.

[Duplex -> Duplex]

Both sides of the original are scanned and copied to separate sides of paper.

[Duplex -> Simplex]

The scanned data of the two sides are copied onto a single side of two separate sheets of paper.

[Paging Direction]

Specify whether pages are opened right/left or top/bottom.

[Original Orientation] (p.64 "Original Orientation")

How to set the combination of scanning sides and printing sides is explained below using an example of copying data scanned from a single side of the original to both sides of paper.

1 Touch [Duplex/Simplex].
The [Duplex/Simplex] screen is displayed.
• If the [Confirm] screen appears, set the original orientation to [Top Side Up] or [Top Side Left].

2 Touch [Simplex -> Duplex].

3 Specify [Paging Direction].

4 Touch [OK].

Sort

Specify the paper output method when making multiple copies.

[Auto]

Select this option if you want the machine to sort the copies in sets when you load the original in the ADF and sort the copies by page when you load the original on the platen glass.

[Collated]

Select this option to make copies in sets.

[Uncollated]

Select this option to copy by page.

1 Touch [Sort].
The [Sort] screen is displayed.

2 Select the sorting type.

3 Touch [OK].

Scanning Level

You can adjust the scanning level of originals.
[-2], [-1], [±0], [+1], [+2]

- 1 **Touch [Scanning Level].**
The [Scanning Level] screen is displayed.
- 2 **Select the scanning level.**
- 3 **Touch [OK].**



- When copying text originals with a background color or originals printed on colored paper with text that is difficult to read when copied, specify [Base Color Level]. This will make it possible to lighten the background color (base color). (p.72 "Base Color Level")

Print Density

You can adjust the amount of ink to be used for printing.
[-3], [-2], [-1], [±0], [+1], [+2], [+3]

- 1 **Touch [Print Density].**
The [Print Density] screen is displayed.
- 2 **Select the print density.**
- 3 **Touch [OK].**

ADF Scan & Pause

When copying a quantity of originals that cannot be loaded at one time in the ADF, these can be copied as one job. Up to 1,000 one-sided originals or 500 two-sided originals can be copied as one job.



- The maximum number of sheets that can be loaded at one time in the ADF is 200 sheets (with a paperweight of 80 g/m² (21-lb bond)).
- Scan all originals using the ADF, and do not use the platen glass.

- You cannot use [ADF Scan & Pause] with [Book Shadow Erasure] or [Scan Job Build] at the same time. (p.66 "Book Shadow Erasure", p.80 "Scan Job Build")

[OFF], [ON]

- 1 **Touch [ADF Scan & Pause].**
The [ADF Scan & Pause] screen is displayed.
- 2 **Touch [ON].**
- 3 **Touch [OK].**
- 4 **Press the [Start] key.**
The [Copying] screen is displayed, and copying of the original starts. The current status is displayed on the screen.
When there are no sheets of the original in the ADF, the original add confirmation screen is displayed.
- 5 **Load the subsequent pages of the original into the ADF, and touch [Scan].**
The scanning of the original starts.
Repeat this step until all pages are scanned.
- 6 **Touch [Scanned].**
The printing of the scanned data starts.

Mixed Size Original

Use this option when loading originals of two different sizes in the ADF.

Load the original with the sides of the same length aligned (A4-LEF* and A3, B5-LEF and B4, or Letter-LEF and Ledger).

* Long Edge Feed

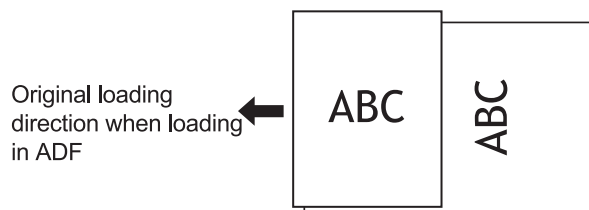



- [Mixed Size Original] cannot be used in combination with the [Scanning Size], [Book Shadow Erasure], [Page Split], [Combine], [Image Repeat], [Booklet], [Page Border], [Overlay], or [Add Cover] options. (p.63 "Scanning Size", p.66 "Book Shadow Erasure", p.67 "Page Split", p.68 "Combine", p.68 "Image Repeat", p.68 "Booklet", p.71 "Page Border", p.73 "Overlay", p.77 "Add Cover")
- You can use any combination of the original size when scanning on the platen glass.
- Use the [Mixed Size Original] option when scanning originals of different sizes on the platen glass and collating the pages.
- The message that prompts you to set [Auto Image Rotation] to [OFF] is displayed when [Mixed Size Original] and [Auto Image Rotation] are set to [ON] or when [Staple], [Punch], or [Binding Margin] is set to [ON]. Touch [OK] to change [Auto Image Rotation] to [OFF] or touch [Cancel] to leave the current setting ([ON]) as it is.

[OFF], [ON]

- 1 Set [Paper Selection] to [Auto].**
For more information, see "Paper Selection" (p.61).
- 2 Touch [Mixed Size Original].**
The [Mixed Size Original] screen is displayed.
- 3 Touch [ON].**
- 4 Touch [OK].**

Book Shadow Erasure

This function removes the shadows that appear in the center (inner margin) when scanning a book or other bound documents.



- When placing a book on the platen glass, place it top side up and aligned with the arrow at the upper left of the glass surface. This function cannot be used with the book placed vertically or at an angle.
- You cannot use [Book Shadow Erasure] with [ADF Scan & Pause] or [Mixed Size Original] at the same time. (p.65 "ADF Scan & Pause", p.65 "Mixed Size Original")

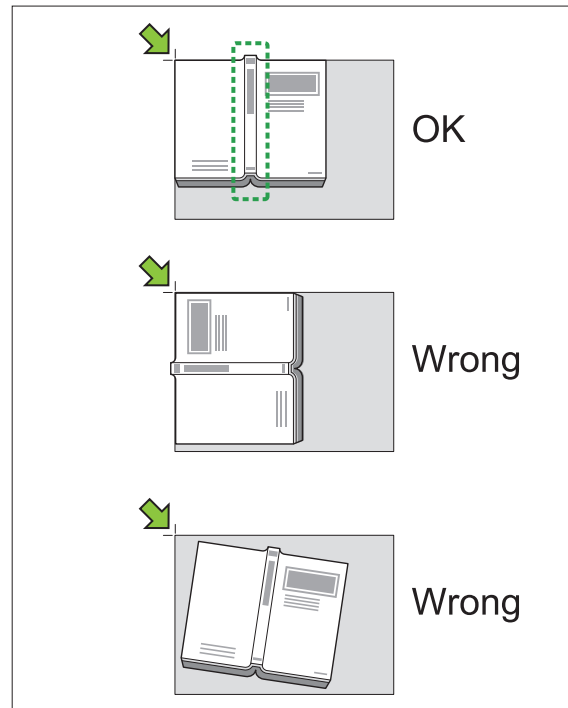

[OFF], [10mm] (3/8"), [20mm] (13/16"), [30mm] (1 3/16"), [40mm] (1 9/16"), [50mm] (1 15/16")
[Page Split] (p.67 "Page Split")

- 1 Touch [Book Shadow Erasure].**
The [Book Shadow Erasure] screen is displayed.
- 2 Select the erasure width.**
- 3 Set [Page Split].**
For more information, see "Page Split" (p.67).
- 4 Touch [OK].**

Page Split

Use this option to scan double-spread pages and split them into two parts (right and left).

The original sizes that can be page-split are as follows.

A3, A4, A5, B4, B5, Ledger, Letter



- When placing a book on the platen glass, place it top side up and aligned with the arrow at the upper left of the glass surface. This function cannot be used with the book placed vertically or at an angle.
- You cannot use [Page Split] and [Mixed Size Original] at the same time. (p.65 "Mixed Size Original")

[Page Order]

[OFF]: The page split function is not available.

[Left to Right]: For books that are opened from the left.

[Right to Left]: For books that are opened from the right.

[Page Selection while Scanning]

[OFF]: Double-spread pages are split into two pages (right and left).

[ON]: You can specify the scan range for double-spread pages.

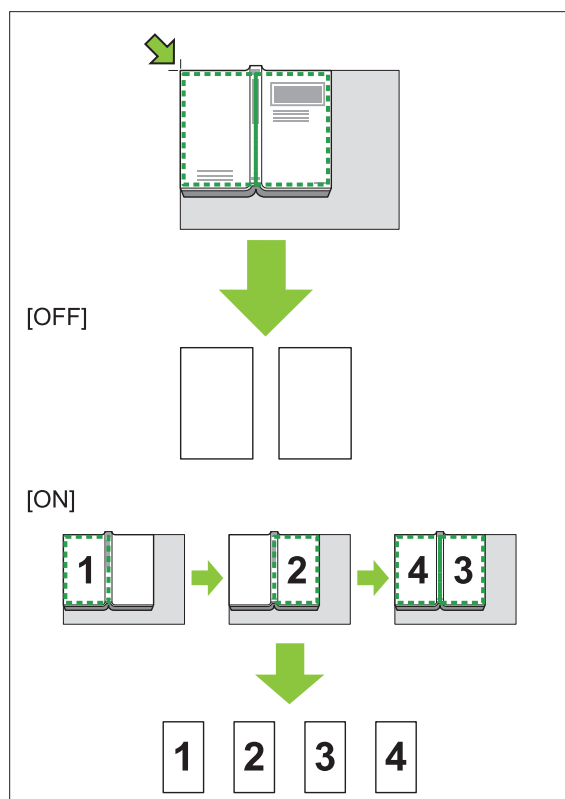

How to set up a page split is explained below using an example of setting [Page Selection while Scanning] to [ON].

1 Touch [Page Split].

The [Page Split] screen is displayed.

2 Specify the page order.



Left to right



Right to left

3 Set [Page Selection while Scanning] to [ON].

4 Touch [OK].

5 Press the [Start] key.

The scan range setting screen is displayed.

6 Select one of the following: [Left Only], [Both Sides], or [Right Only].

7 Touch [Scan].

The scanning of the original starts.

Repeat steps 6 and 7 until all pages are scanned.

8 Touch [Scanned].

The printing of the scanned data starts.

Combine

This function imposes continuous pages onto one sheet.



- You cannot use the [Combine] function with [Mixed Size Original], [Image Repeat], [Booklet], or [Overlay] function. (p.65 "Mixed Size Original", p.68 "Image Repeat", p.68 "Booklet", p.73 "Overlay")

[Pages/Sheet]

[OFF], 2 pages, 4 pages, 8 pages

[Layout]

Specify the order of page imposition.

Example: Portrait document

Pages per sheet	Layout
2 pages	
4 pages	
8 pages	

[Original Orientation] (p.64 "Original Orientation")

1 Touch [Combine].

The [Combine] screen is displayed.

- If the [Confirm] screen appears, set the original orientation to [Top Side Up] or [Top Side Left].

2 Specify the number of pages per sheet.

3 Select a layout.

4 Touch [OK].

Image Repeat

Impose multiple copies of the same original onto one sheet.



- You cannot use the [Image Repeat] function with [Mixed Size Original], [Combine], [Booklet], or [Overlay] function. (p.65 "Mixed Size Original", p.68 "Combine", p.68 "Booklet", p.73 "Overlay")

[OFF], [2 Pages], [4 Pages], [8 Pages]

[Original Orientation] (p.64 "Original Orientation")

1 Touch [Image Repeat].

The [Image Repeat] screen is displayed.

- If the [Confirm] screen appears, set the original orientation to [Top Side Up] or [Top Side Left].

2 Select the number of pages per sheet.

3 Touch [OK].

Booklet

This function is used for duplex printing of continuous pages imposed onto one sheet.



- You cannot use the [Booklet] function with the [Reproduction Size], [Mixed Size Original], [Combine], [Image Repeat], [Page Border], [Overlay], or [Binding Margin] function. (p.61 "Reproduction Size", p.65 "Mixed Size Original", p.68 "Combine", p.68 "Image Repeat", p.71 "Page Border", p.73 "Overlay", p.78 "Binding Margin")

Types of paper that can be used to create booklets
A3, B4, A4, B5, Ledger, Legal, Letter, Foolscap, and custom size

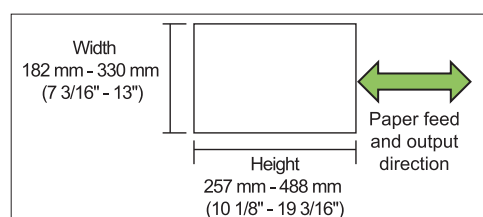



- You cannot use the paper which has a width longer than its height.

[Layout Order]

Specify the layout order.
When this option is set to [OFF], the imposition function is not available.

1 Touch [Booklet].
The [Booklet] screen is displayed.

2 Configure the layout order.

3 Touch [OK].



- When using the optional multifunction finisher, you can configure [Binding], [Separating Books], [Center Margin], and [Auto Reduction]. For more information, see "Binding ([Booklet])" (p.213) and "Separating Books ([Booklet])" (p.213) in "Optional Equipment".

Stamp

Stamp the page number, date, or text in the header or footer.



- The page number and date cannot be stamped on slip sheet paper or cover paper. (p.77 "Separation", p.77 "Add Cover")
- When using this function with [Combine] or [Image Repeat], the page number and date are stamped on each page of the copy paper, not per page of the original. When using this function with [Booklet], the page number and date are stamped on each booklet page.
- Specifying the reproduction size does not affect the stamp size.
- The [Stamp] and [Page Border] functions cannot be used at the same time. (p.71 "Page Border")

[Page], [Date], [Text]
Select the type of stamps to be stamped.

[Print Position]
Specify the stamping position.
If [OFF] is selected, the stamp cannot be printed.

[Text Size]
Specify the text size for printing.

[Transparency]
[OFF]: Images are removed from the stamp area to create a white space, and the stamp is printed in that white space.
[ON]: The stamp is printed over an image when the stamp area and an image overlap.

[Start Number]
Specify the first number for the page stamp.

[Stamp Start Page]
Specify on which page to start the page stamps.

Example: When the stamp start page is set to "2" and the stamp start number is set to "3"

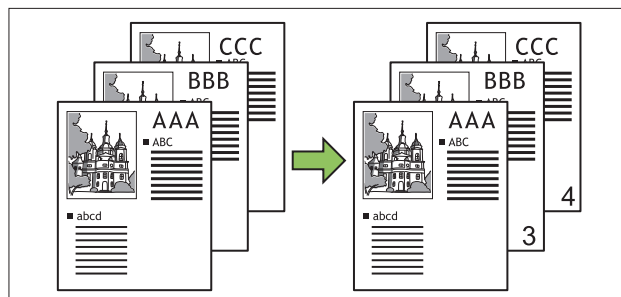

[Apply Page]
Specify the pages on which to print the date stamp or text stamp.
[All Pages]: The stamp is applied to all pages.
[First Page Only]: The stamp is applied only to the first page.

[Stamp Date]
Configure the date to use for the date stamp.
[Today]: Today's date (the date set on the machine) is stamped.
[Specify Date]: The specified date is stamped.

[Text to be printed]
Configure the text to use for the text stamp.

Configure the Page Stamp

1 Touch [Stamp].
The [Stamp] screen is displayed.

2 Touch [Page].

3 Configure the print position.



- You cannot print different types of stamps in the same position. If the arrow for configuring the print position is grayed out and cannot be selected, select another position.

4 Specify the text size.

Touch [▼] or [▲] to specify the size. You can also touch the text box for [Text Size] and enter a size by using the number pad.

5 Set the transparency option.

6 Specify the start number.

7 Specify the stamp start page.

8 Touch [OK].

Configure the Date Stamp

1 Touch [Stamp].

The [Stamp] screen is displayed.

2 Touch [Date].

3 Specify the print position.



- You cannot print different types of stamps in the same position. If the arrow for configuring the print position is grayed out and cannot be selected, select another position.

4 Specify the text size.

Touch [▼] or [▲] to specify the size. You can also touch the text box for [Text Size] and enter a size by using the number pad.

5 Set the transparency option.

6 Set the apply page option.

7 Set the date to be stamped.

To specify a date of your choice, touch [Specify Date] and touch the input screen displayed on the screen to set the date.

You can also enter the number using the numeric keys.

8 Touch [OK].

Configure the Text Stamp

1 Touch [Stamp].

The [Stamp] screen is displayed.

2 Touch [Text].



- You cannot change the font.

3 Configure the print position.



- You cannot print different types of stamps in the same position. If the arrow for configuring the print position is grayed out and cannot be selected, select another position.

4 Specify the text size.

Touch [▼] or [▲] to specify the size. You can also touch the text box for [Text Size] and enter a size by using the number pad.

5 Set the transparency option.

6 Set the apply page option.

7 Configure the text to be printed.

8 Touch [OK].

Page Border

This option adds a border line in the margins of the paper.



- Even when this option is used with [Combine] or [Image Repeat], the border line is printed on each copy paper, not per page of the original.
- The border lines are printed over the original data. If there is an overlap of an image in the border printing area, part of the image may not be printed.
- When [Color Mode] is set to [Black], [Cyan], or [Magenta], colors that are not selectable are grayed out. (p.61 "Color Mode")
- Printing a border on black-and-white copies can make posters and signs stand out.
- You cannot use [Page Border] with [Mixed Size Original], [Booklet], [Stamp], [Add Cover], or [Binding Margin] at the same time. (p.65 "Mixed Size Original", p.68 "Booklet", p.69 "Stamp", p.77 "Add Cover", p.78 "Binding Margin")

[OFF], [Red], [Blue], [Green], [Yellow], [Black]
Thickness of the border line (manual entry)

1 Touch [Page Border].

The [Page Border] screen is displayed.

2 Select a border line color.

3 Touch [▼] or [▲] to specify the thickness of the border line.

You can also enter the number using the numeric keys.

4 Touch [OK].

Image Quality

Specify the resolution for scanning originals.

[Standard (300x300 dpi)]

Select this when the original has mostly text.

[Fine (300x600 dpi)]

Select this when the original has photos. The original is printed at a speed lower than when selecting [Standard (300x300 dpi)], but it is scanned with higher resolution.

1 Touch [Image Quality].

The [Image Quality] screen is displayed.

2 Select a resolution.

3 Touch [OK].



- When [Color Mode] is set to [Black], [Image Quality] is grayed out and cannot be selected. The resolution is set to [Standard (600x600 dpi)].
- The resolution for black is always set to 600x600 dpi regardless of whether you select [Standard (300x300 dpi)] or [Fine (300x600 dpi)].

Original Type

Select the original type so that the appropriate image processing is performed before printing the scanned data.

[Line/Photo]

Select this when the original has both text and photos.

[Line]

Select this when the original has text or illustrations.

[Photo]

Select this when the original has photos.

[Map/Pencil]

Select this for originals with a lot of subtle colors or fine lines, such as a map, or for originals with pencil drawings.

[Dot Process]

[Auto]: Gradation is automatically expressed through the density of dots. The higher the density, the darker the gradation. The lower the density, the lighter the gradation.

[70 lpi]: Photos are reproduced with a printing resolution of 70 lpi.

[100 lpi]: Photos are reproduced with a printing resolution of 100 lpi.

1 Touch [Original Type].

The [Original Type] screen is displayed.

2 Select the original type.

3 If [Line/Photo], [Photo], or [Map/Pencil] is selected, set [Dot Process].

4 Touch [OK].

Gamma Correction

This function adjusts the color balance (CMYK) of the scanned data.



- When [Color Mode] is set to [Black], [Cyan], or [Magenta], the gamma value can only be adjusted for black (K). (p.61 "Color Mode")

[C] - [R]

[1], [2], [3], [4], [5], [6], [7]

The lower the value (lowest being [1]), the stronger the cyan (C) is in the image. The higher the value (highest being [7]), the stronger the red (R) is in the image.

[M] - [G]

[1], [2], [3], [4], [5], [6], [7]

The lower the value (lowest being [1]), the stronger the magenta (M) is in the image. The higher the value (highest being [7]), the stronger the green (G) is in the image.

[Y] - [B]

[1], [2], [3], [4], [5], [6], [7]

The lower the value (lowest being [1]), the stronger the yellow (Y) is in the image. The higher the value (highest being [7]), the stronger the blue (B) is in the image.

[K]

[1], [2], [3], [4], [5], [6], [7]

The higher the value (highest being [7]), the stronger the black (K) is in the image.

1 Touch [Gamma Correction].

The [Gamma Correction] screen is displayed.

2 Select the balance for each color.

[Output Image] displays a preview of the image with the adjusted color balance.

3 Touch [OK].

Image Control

Specify the appropriate image processing settings for the scanned data.

[Auto]

The values are automatically configured based on the [Color Mode] and [Original Type] settings. (p.61 "Color Mode", p.71 "Original Type")

[Line/Photo Level]

[1], [2], [3], [4], [5], [6], [7]

The higher the value (highest being [7]), the higher the text recognition level applied is (even text with unclear outlines is recognized as text).

[Edge Enhancement]

[1], [2], [3], [4], [5], [6], [7]

The higher the value (highest being [7]), the greater the edge emphasis is for parts recognized as text.

[Moire Elimination]

[1], [2], [3], [4], [5], [6], [7]

The higher the value (highest being [7]), the greater the reduction of moire is for parts recognized as a photo.

1 Touch [Image Control].

The [Image Control] screen is displayed.

2 Configure the details for image processing.

3 Touch [OK].

Base Color Level

This function makes the background color (base color) lighter so that the text is easier to read when copying text originals with a background color or originals printed on colored paper.

[1], [2], [3], [4], [5], [6], [7]

The higher the value, the more the background color level is reduced.

[Auto]

The density of the background color is set automatically.

1 Touch [Base Color Level].

The [Base Color Level] screen is displayed.

2 Configure the base color level settings.

3 Touch [OK].

Image Position

Adjust the printing position of images.

[Front Side], [Back Side]

Select which side to adjust the image position for.

[Reset]

Select this option to return the adjusted value for the selected side (front or back side) to 0 mm.

[▲]/[▼]/[◀]/[▶]

Use these keys to move the position of images.

1 Touch [Image Position].

The [Image Position] screen is displayed.

2 In the case of duplex printing, select the side to adjust the image position for ([Front Side] or [Back Side]).

3 Touch [▲], [▼], [◀], and/or [▶] to adjust the image position.

4 Touch [OK].



- You can adjust the printing position a maximum of ± 20 mm (25/32") up, down, left, or right, in increments of 0.5 mm (1/64").
- When performing duplex printing, the front and back sides can be adjusted separately.

Overlay

Make copies upon layering an image that has been saved on the storage.



- [Overlay] cannot be used together with the following functions:
 - Reproduction Size (p.61)
 - Mixed Size Original (p.65)
 - Combine (p.68)
 - Image Repeat (p.68)

- Booklet (p.68)
- Program (p.74)
- Add Cover (p.77)
- Auto Image Rotation (p.79)
- Processing Speed Priority (Image Quality) (p.121)
- If you are using the optional stacking tray or multifunction finisher, set the output destination to [Auto] or [Face Down Tray].

[OFF], [ON]

[Folder Name]

The name of the folder where the image specified with [Image selection] is displayed here.

[Document Name]

The name of the file for the image specified with [Image selection] is displayed here.

[Image selection]

Specify the image to overlay.

[Target Page(s)]

Configure which pages of the image file are to be targeted.

[Repetition]

Configure whether to repeatedly use the applicable page of the image file.

[Priority Layer]

Configure whether to overlay the original or the overlay image on top.

Preview Area

Use this area to check the applicable pages of the overlay image, repetition of the image, and the settings for the preferred layer.

1 Touch [Overlay].

The [Overlay] screen is displayed.

2 Touch [ON].

3 Touch [Image selection].

The [Overlay Image Selection] screen is displayed.

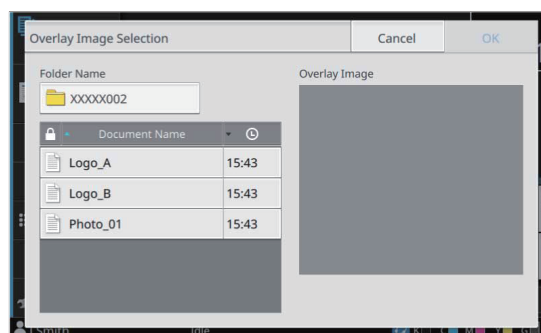

In order to change the folder, touch the text box for [Folder Name]. Select the folder in the [Select Folder] screen and touch [OK].
From the list of documents, select the file to use as the overlay image and touch [OK]. You will be returned to the [Overlay] screen.



- When a document is selected from the list, a preview will be displayed in [Overlay Image]. Touch [◀] / [▶] to switch between pages.
- Touch [Details] to display the [Details] screen and check the details of the document.

4 Configure the target pages.

When there are multiple pages in the file to use as the overlay image, select which page will be applicable.

[All pages]: All pages will be used as the overlay image. The image will be layered over the original in order from the first page.

[First page]: The image on the first page only will be used as the overlay image.



- It is not possible to specify a specific page other than the first page.

5 Configure the repetition.

[ON]: The overlay image will be repeatedly layered over the original.

[OFF]: The image will not be repeated. The image on the specified page in the specified file will be used just once in order over the original. The image will not be layered over the rest of the pages of the original.

6 Configure the Priority Layer.

[Original]: The original will be layered on top of the overlay image.

[Overlay Image]: The overlay image will be layered on top of the original.

7 Touch [OK].



- Use an overlay image (image saved in the storage) that is the same size as the original. The image cannot be enlarged or reduced for layering.
- The overlay image is to be saved in the storage with the setting for simplex printing.

- When the resolution of the original differs from the resolution of the overlay image, the printout may become coarse. Make copies upon matching the [Image Quality] settings for the original and the overlay image.
- Even when the overlay image is a color image, if the copy is set to black and white, the image will also be copied in black and white.
- If the size or orientation of the paper differs between the original and overlay image, the overlay function will be unavailable.
- Documents are saved in the storage in the form of data that includes setting details. When printing a document, be sure to do so with the same type of paper as that which was configured when the document was saved in the storage. When you change the paper type, the printing result changes.
- If the original and the overlay image overlap on the portions having the same color, it might be difficult to distinguish the image of the assimilated portions.

Program

When you want to distribute the different number of copies by group (such as classes or corporate division), you can quickly print the necessary number of copies with a single copy job.

For example, to distribute a leaflet to the parents of all first-grade students in school, you can print by dividing copies by class.



- You need to register a program for the number of copies and sets, sorting, slip sheets, and other options for each group beforehand.
- [Program] cannot be used together with [Sort], [Overlay], or [Separation]. (p.64 "Sort", p.73 "Overlay", p.77 "Separation")

■ Entering the Number of Copies and Sets

Group [01] - [60]

Set a program in which one group is combined with both the numbers of copies and sets. You can configure up to 60 groups.

[Copies]

Enter the number of copies to be copied. You can configure up to 9,999 copies.

[Sets]

Specify how many sets you need to copy based on the number of copies entered in [Copies] as one set.

You can configure up to 99 sets.

<Setting Example>

The following describes how to configure the settings when printing by dividing copies by the number of students in each class.

Class	1-A	1-B	1-C
No. of students	30	32	30
Necessary number of copies	30	32	30

Divide groups into class units and specify the numbers in [Copies] and [Sets] respectively for each group. Enter the number of students in [Copies].

To print one set of copies specified, enter 1 in [Sets].

Class	Settings on the operation panel		
	Group	Copies	Sets
1-A	01	30	1
1-B	02	32	1
1-C	03	30	1

In addition, when multiple groups have the same necessary number of copies, you can group them together as one group by increasing the number of sets. In this case, both Classes 1-A and 1-C have the same number of copies, so that you can configure the settings as follows to print by dividing copies by class.

Class	Settings on the operation panel		
	Group	Copies	Sets
1-A, 1-C	01	30	2
1-B	02	32	1

■ About the Separation Settings

[Sort]

[Auto]: The copies are sorted in sets when you load the original in the ADF and sorted by page when you load the original on the platen glass.

[Collated]: Copies are made in sets.

Set the [Sort] option to [Uncollated] to copy by page.

[Slip Sheet]

[OFF]: Slip sheets are not inserted.

When this option is set to [Between Sets], a slip sheet is inserted between each set.

When this option is set to [Between Groups], a slip sheet is inserted between each group.

[Paper]

Specify the paper tray in which slip sheets are loaded.

[Number Printing]

[ON]: Numbers will be printed.

The group number and set number are printed when [Slip Sheet] is set to [Between Sets], and only the group number is printed when [Slip Sheet] is set to [Between Groups].

Saving a Program

You can register up to 12 programs and call them whenever necessary.

1 Touch [Program].

The [Program] screen is displayed.

2 Touch [No Entry], and then touch [Edit].

The program edit screen is displayed.

3 Enter the number of copies and sets using the numeric keys.

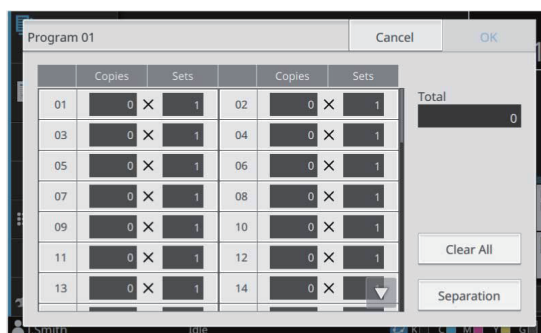

4 Touch [Separation].

The [Separation] screen is displayed.

5 Set the sort and slip sheet options.

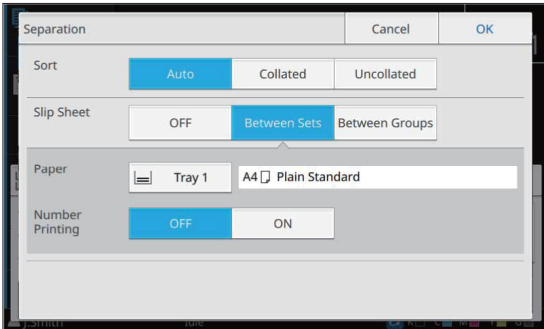

Set the [Paper] and [Number Printing] options as well if necessary.



- If you are using the optional face down finisher, high capacity stacker, or multifunction finisher, you can configure [Offset Output]. For more information, see the following:
 - When using the face down finisher (p.183 "Offset Output ([Program])")
 - When using the high capacity stacker (p.200 "Offset Output ([Program])")
 - When using the multifunction finisher (p.214 "Offset Output ([Program])")

6 Touch [OK].

The [Confirm] screen is displayed.

7 Select [Overwrite] or [Register As].

To save by giving it a name, enter a program name and touch [OK].
The registration is now complete.
In the [Confirm] screen, touch [Close].



- If [Do not register] is selected, the detailed settings that have been specified are canceled and the display returns to the program edit screen.

8 Touch [OK].

Retrieving a Program

You can call a saved program.

1 Touch [Program].

The [Program] screen is displayed.

2 Select the program to call.

The registered number of copies and sets are displayed in a list.

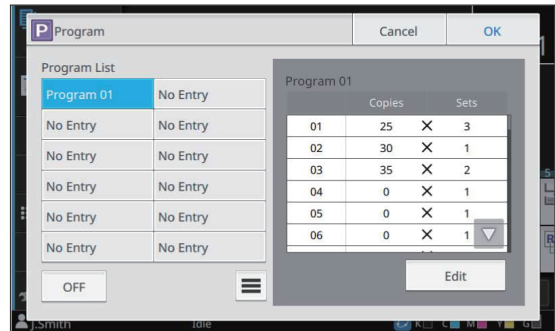

3 Touch [OK].

Changing the Program Settings

You can change a saved program.

1 Touch [Program].

The [Program] screen is displayed.

2 Select a program.

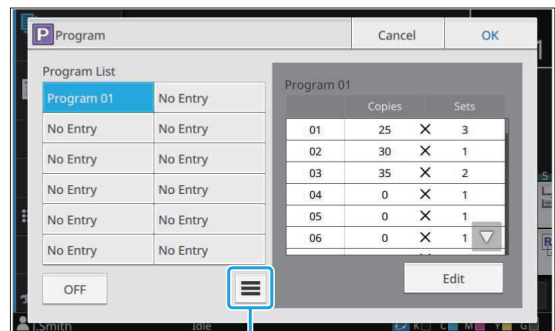

Sub menu

The following setting can be configured from the sub menu:

- Rename
- Delete

Follow the on-screen instructions to change the settings.

3 Touch [Edit].

For specific instructions on subsequent operations, see steps 3 through 8 in "Saving a Program" (p.75).

Add Cover

You can load printed paper or colored paper into a paper tray to add to the front and back of the printed document as a cover.



- You cannot use paper of a different size from that of the copy paper.
- You cannot use [Add Cover] with [Mixed Size Original], [Page Border], or [Overlay] at the same time. (p.65 "Mixed Size Original", p.71 "Page Border", p.73 "Overlay")

[Binding Edge]

Specify the binding edge.

[Front Cover]

Set this option to [ON] to add a cover to the front of each printout.

[Back Cover]

Set this option to [ON] to add a cover to the back of each printout.

[Paper Tray]

Specify the feed tray that is loaded with cover paper.

1 Touch [Add Cover].

The [Add Cover] screen is displayed.

2 Select the binding side.

3 Configure the cover settings.

Select [OFF] or [ON] for the front and back covers.

4 Touch the paper tray.

The [Select Tray] screen is displayed.

5 Select a paper tray and touch [OK].

6 Touch [OK].

7 Load the cover paper.



- The side in which the paper is loaded varies depending on the tray.
[Front Cover]
Standard tray / Optional additional tray:
Load the paper with the first page facing up.
Feed tray: Load the paper with the first page facing down.

[Back Cover]

Standard tray / Optional additional tray:
Load the paper with the first page facing down.

Feed tray: Load the paper with the first page facing up.

For more information, see "Loading the Paper" (p.46).

- Change the [Paper Selection] settings according to the loaded paper. (p.61 "Paper Selection")

Separation

Insert a slip sheet between pages or sets, or to separate jobs.



- When loading special paper to be used as slip sheets, it is recommended that [Auto Selection] be set to [OFF] for the paper tray for slip sheets. (p.62 "Changing the Paper Tray Setting")
- You cannot use the [Separation] function with the [Program] function at the same time. (p.74 "Program")

[Slip Sheet]

[OFF]: Slip sheets are not inserted.

[Between Sorts]: A slip sheet is inserted for each unit specified in [Sort].

[After a Job]: A slip sheet is inserted after every printed job.

[Paper]

Specify the paper tray in which slip sheets are loaded.

[Number Printing]

[OFF]: Numbers are not printed.

[1 2 3 ...]: Numbers are stamped on slip sheets in numerical order (1, 2, 3...).

[A B C...]: Letters are stamped on slip sheets in alphabetical order (A, B, C... Z, AA, AB...). (Up to ZZZ)

The text is printed at the bottom (within approx. 5 mm (7/32") of the edge) or top (within approx. 5 mm (7/32") of the edge) of the sheet.

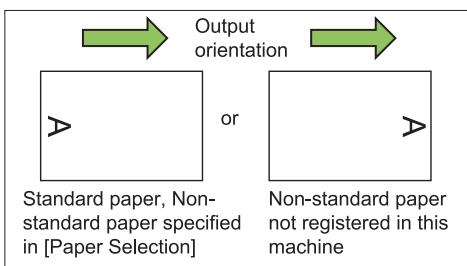

- 1 **Touch [Separation].**
The [Separation] screen is displayed.
- 2 **Select the position where slip sheets are to be inserted.**
- 3 **Touch the paper tray.**
The [Select Tray] screen is displayed.
- 4 **Select the paper tray for slip sheets and touch [OK].**
- 5 **Configure the [Number Printing] setting.**
- 6 **Touch [OK].**



- If you are using the optional face down finisher, high capacity stacker, or multifunction finisher, you can configure [Offset Output]. For more information, see the following:
 - When using the face down finisher (p.183 "Offset Output ([Separation])")
 - When using the high capacity stacker (p.200 "Offset Output ([Separation])")
 - When using the multifunction finisher (p.214 "Offset Output ([Separation])")

Binding Margin

Specify the binding margin.



- You cannot use the [Binding Margin] function with the [Booklet] or [Page Border] function. (p.68 "Booklet", p.71 "Page Border")

[Binding Edge]

Specify the binding edge.

Width

Enter the width using [▲], [▼], or the numeric keys.

[Auto Reduction]

Set this option to [ON] to automatically reduce the image size to fit the image on the paper in order to prevent the edges from not being printed even when a margin width is specified.

- 1 **Touch [Binding Margin].**
The [Binding Margin] screen is displayed.
- 2 **Specify the binding margin.**
 - Select [Binding Edge].
 - Use [▲], [▼], or the numeric keys to enter the width.
 - Turn [Auto Reduction] to [ON] in order to prevent the edges from not being printed even when a margin width is specified.
- 3 **Touch [OK].**

Staple / Punch

If you are using the optional face down finisher or multifunction finisher, the staple function is available at the specified position. The binding margin can also be configured. If you are using the optional multifunction finisher with the punch unit, you can also configure the punch setting. For more information, see the following:

- When using the face down finisher (p.184 "Staple")
- When using the multifunction finisher (p.214 "Staple / Punch")

Fold

When using the optional multifunction finisher, you can configure how the paper is folded. For more information, see "Fold" (p.215) in "Optional Equipment".

Slow Printing

You can slow down the printing speed. This also reduces the amount of noise produced by the machine when printing jobs.

[OFF], [ON]

- 1 **Touch [Slow Printing].**
The [Slow Printing] screen is displayed.
- 2 **Touch [ON].**
- 3 **Touch [OK].**

Output Tray

If you are using the optional stacking tray, high capacity stacker, or multifunction finisher, you can select the trays for output of the printed materials. For more information, see the following:

- When using the stacking tray (p.194 "Output Tray")
- When using the high capacity stacker (p.201 "Output Tray")
- When using the multifunction finisher (p.217 "Output Tray")

Face Up/Down

If you are using the optional stacking tray, high capacity stacker, or multifunction finisher, you can configure whether to output the printouts face up or face down.

For more information, see the following:

- When using the stacking tray (p.194 "Face Up/Down")
- When using the high capacity stacker (p.201 "Face Up/Down")

- When using the multifunction finisher (p.217 "Face Up/Down")

Output Tray Relay

When using the auto-control stacking tray, high capacity stacker, or multifunction finisher, the output tray switches automatically when the tray that is being used becomes full.

For more information, see the following:

- When using the auto-control stacking tray (p.194 "Output Tray Relay")
- When using the high capacity stacker (p.201 "Output Tray Relay")
- When using the multifunction finisher (p.217 "Output Tray Relay")

Paper Tray Relay

Use this option to automatically feed paper from a different tray with the same paper size and paper type when the selected tray runs out of paper.

[OFF], [ON]

- 1 **Touch [Paper Tray Relay].**
The [Paper Tray Relay] screen is displayed.
- 2 **Touch [ON].**
- 3 **Touch [OK].**

Auto Image Rotation

This rotates the image 90 degrees automatically when the orientations of the original and paper do not match, even if the paper size loaded in the tray matches the size of the loaded original. Normally, this setting is set to [ON].



- [Auto Image Rotation] cannot be used together with [Overlay]. (p.73 "Overlay")

Scan Job Build

You can collectively copy multiple originals scanned with different settings as one job. This option is convenient when the originals vary in type and image quality.



- The [Scan Job Build] and [ADF Scan & Pause] functions cannot be used at the same time. (p.65 "ADF Scan & Pause")

[OFF], [ON]

1 Touch [Scan Job Build].

The [Scan Job Build] screen is displayed.

2 Touch [ON].

3 Touch [OK].

4 Load the original and press the [Start] key.

Scanning of the original starts, and when it is completed, the [Confirm] screen is displayed.

5 Touch [Change Setting].

The [Copy] screen is displayed.

6 Change the copy settings as needed.



- You can change only the following copy settings when scanning from the second time.
[Color Mode], [Reproduction Size], [Original Orientation], [Scanning Level], [Book Shadow Erasure], [Page Border], [Original Type], [Gamma Correction], [Image Control], [Base Color Level]

7 Load the next original and press the [Start] key.

Scanning of the original starts, and when it is completed, the [Confirm] screen is displayed.

8 Repeat steps 5 to 7 as needed.

If you do not have to change the settings, follow the displayed messages for operation.

9 Touch [Scanned] on the [Confirm] screen.

The scanned data is printed.

Interrupt Copy

This function allows you to pause the job being printed to copy another document.



- The following functions are not available for interrupt copy:
[Program], [Slip Sheet], [Add Cover], [ADF Scan & Pause], [Scan Job Build]
- An interrupt copy cannot be made while a job using the staple function or offset output function is being processed with the face down finisher. The interrupt copy function is available when any one of the optional stacking trays, high capacity stacker, or multifunction finisher is connected.
- When performing an interrupt copy with a job being output to the multifunction finisher, the following settings are unavailable:
[Staple / Punch], [Fold], [Binding], [Output Tray], [Face Up/Down], [Output Tray Relay]

1 Press the [Interrupt] key.

The interruption screen is displayed.

2 Load the original and press the [Start] key.

- You can continue with the interrupt copy operation while the [Ready to copy. (Interrupting)] message is displayed.

3 After copying is completed, press the [Interrupt] key to cancel interrupt copy.

Printing of the paused job resumes.

- Interrupt copy is also canceled when the machine has not been operated for 60 seconds.

Copy Mode Function Buttons

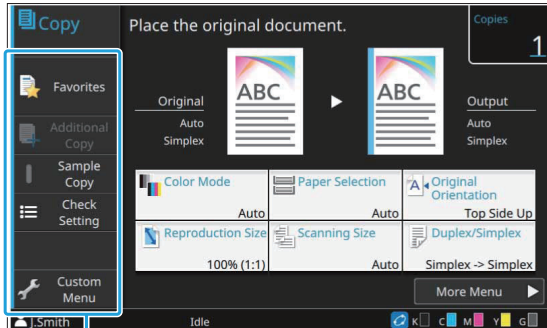

Function buttons

Favorites

Settings can be called whenever necessary. The recommended settings are pre-registered as favorites. Registering frequently used settings can be useful. For more information, see "Adding to Favorites" (p.82).

1 Touch [Favorites].
The [Favorites] screen is displayed.

2 Select one of the favorites.
Set values are shown in a list on the screen. The following settings can be configured from the sub menu:

- Rename
- Delete

3 Touch [OK].



• You cannot rename or delete favorites that are registered as factory settings.

Additional Copy

This function prints out a copy of the original that was copied last. The original does not need to be scanned again.



• Additional Copy cannot be made in the following cases:

- When the administrator has not permitted the use of the additional copy function
- When auto reset has been executed after copying the original
- When the user is logged out

1 Touch [Additional Copy] after the copy job is finished.

The [Additional Copy] screen is displayed.

2 Use the numeric keys to specify the number of copies.

3 Touch [OK].
Printing of additional copies starts.

Sample Copy

The printing stops after one copy has been printed. This function allows you to check the output before making a large number of printouts.



• If you set [Sort] to [Collated], you can use this function to make one copy as a sample. (p.64 "Sort")

1 Touch [Sample Copy].
The [Sample Copy] screen is displayed.

2 Touch [ON].

3 Touch [OK].

4 Press the [Start] key.
The [Making sample copies] screen is displayed, and copying of the original starts. The current status is displayed on the screen.

- The copying can be paused with the [Stop] key. (p.57 "Canceling Copying")

- Touch [Slow Printing] to slow down the printing speed. This also reduces the amount of noise produced by the machine when printing jobs.
- The [Confirm] screen appears after a sample copy is printed.
- You can change the following settings:
- [Change Setting] (p.58 "Changing Settings During Copying")
 - [Maintenance] (p.58 "Performing Maintenance During Copying")

Check Setting

Use this option to check the current settings.

1 Touch [Check Setting].

- The [Check Setting] screen is displayed. Check the current settings.
- The following setting can be configured from the sub menu:
- Add to Favorites
 - Save as Default
 - Setting Confirmation Print

2 Touch [Back].

Custom Menu

You can register favorites and default settings, and edit the button order.

Adding to Favorites

Register the settings and the number of copies for a setting button as a favorite. You can register up to 30 favorites.

Perform the operation while the details you wish to register are configured.

1 Touch [Custom Menu].

The [Custom Menu] screen is displayed.

2 Touch [Favorites Create/Edit].

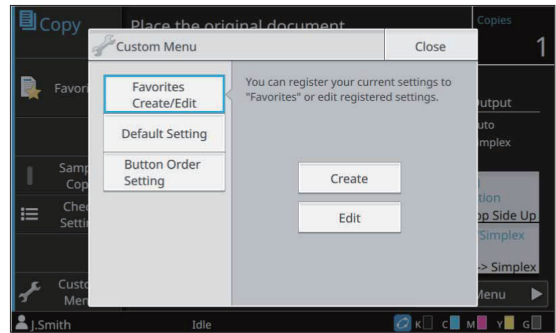

3 Touch [Create].

The [Add to Favorites] screen is displayed. Check the current settings.

4 Touch [OK].

5 Enter the registration name and touch [OK].

The settings are registered as a favorite.

6 Touch [Close].



- The following setting cannot be registered as favorites:
 - [Paper Selection]

Editing Favorites

You can change the display order of favorites.

1 Touch [Custom Menu].

The [Custom Menu] screen is displayed.

2 Touch [Favorites Create/Edit].

3 Touch [Edit].

The [Edit Favorites] screen is displayed.

4 Select one of the favorites.

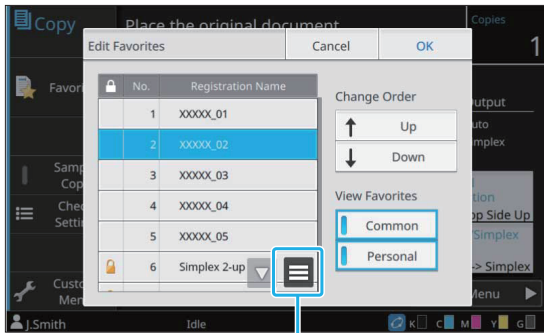

Sub menu

Favorites with a lock icon cannot be edited. The following settings can be configured from the sub menu:

- Check Setting
- Rename
- Delete

5 Touch [Up] or [Down] to set up the order.

6 Configure the [View Favorites] setting.

- When you select [Common], the favorites registered by the administrator and the favorites registered as factory settings are displayed.
- When you select [Personal], the favorites registered by the users currently logged in are displayed.
- You can also select both [Common] and [Personal].



- [View Favorites] may not be displayed depending on the configuration by the administrator. In this case, the favorites registered by the administrator and the favorites registered as factory settings are displayed.

7 Touch [OK].

8 Touch [Close].

Saving as Default

You can register the values and the number of copies set using the setting buttons as default settings. Perform the operation while the details you wish to register are configured.

1 Touch [Custom Menu].

The [Custom Menu] screen is displayed.

2 Touch [Default Setting].

3 Touch [Entry].

The [Save as Default] screen is displayed. Check the current settings.

4 Touch [OK].

The settings are registered as default settings.

5 Touch [Close].

Clearing Defaults

Clear a default value registered by an individual and return the value to the common default value.

1 Touch [Custom Menu].

The [Custom Menu] screen is displayed.

2 Touch [Default Setting].

3 Touch [Clear].

The [Initialize] screen is displayed.

4 Touch [OK].

The default values are cleared.

5 Touch [Close].



- The administrator privilege is required in order to clear a common default value. Contact your administrator for details.

Editing Button Order

This function changes the arrangement of setting buttons.

- 1 Touch [Custom Menu].**
The [Custom Menu] screen is displayed.
- 2 Touch [Button Order Setting].**
The [Button Order Setting] screen is displayed.
- 3 Select one of the setting buttons.**

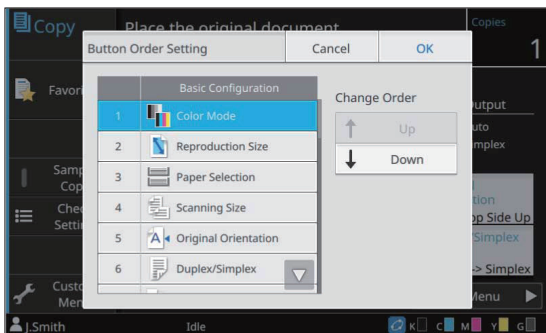

- 4 Touch [Up] or [Down] to set up the order.**
- 5 Touch [OK].**
The arrangement of the setting buttons is completed.
- 6 Touch [Close].**



- The administrator privilege is required in order to configure the common button order. Contact your administrator for details.

Scanning

You can scan a paper original and save this as data.

Select a folder to save the data in to suit the intended purpose.

Data that has been scanned can be saved on a computer on the network, sent as an e-mail attachment, or saved on the internal solid state drive (SSD) of this machine and downloaded from the RISO console.

Overview of Scan Operations

p.86

1. Load the original.



2. Touch [Scan] on the [Home1] screen.



3. Specify an address or destination.



4. Change the settings.



5. Check the preview display.



6. Press the [Start] key.

Scan Settings

p.90

This section explains each scan setting in detail.

Scan Mode Function Buttons

p.95

This section explains the functions available in the Scan mode.



Overview of Scan Operations

This section explains the basic scan operations.

Procedure

1 Load the original.

For more information on the types of originals that can be used, see "Originals" (p.22).



- The machine cannot scan the area within 1 mm (3/64") of the edge of the paper. (Any part of the image within this area will be lost.)

■ In the ADF

1) Load the original in the ADF.

Align the originals and place them face up.

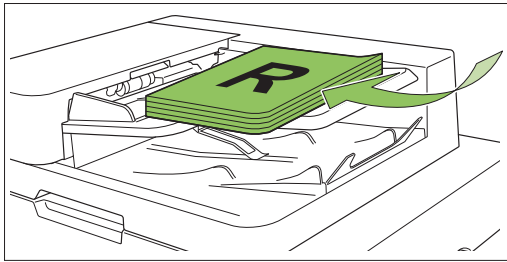

2) Slide the original guides to match the width of the originals.

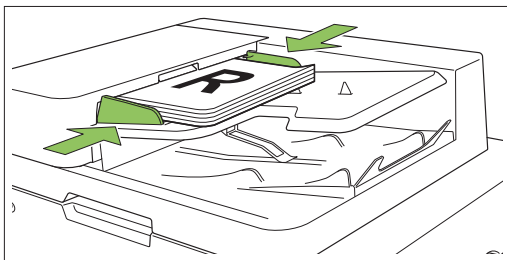

■ On the Platen Glass

1) Open the original cover.

2) Load the originals.

Load the original face down on the glass. Align the corner of the original with the upper-left corner of the glass.

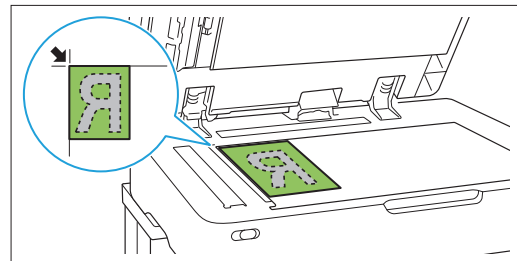

3) Close the original cover.



- Open and close the original cover gently.

2 Touch [Scan] on the [Home1] screen.

Select [Mail], [PC], or [Console].

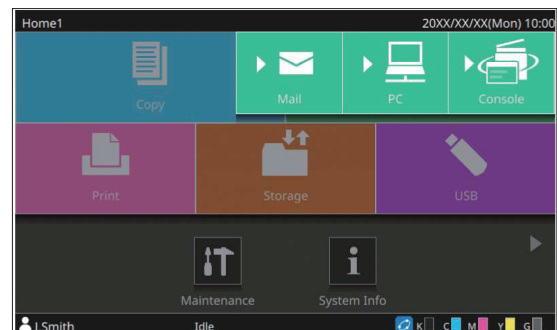

3 Specify an address or destination.

If you select [Mail] or [PC], specify the address/destination for the scanned data.



- If you select [Console], you do not need to specify the destination. The scanned data is saved to the internal SSD of the machine.

■ When you have selected [Mail]

You can attach the scanned data to e-mail messages and send them.

1) Touch [Address].

The [Address] screen is displayed.

2) Select an address from [Mail Address Book].

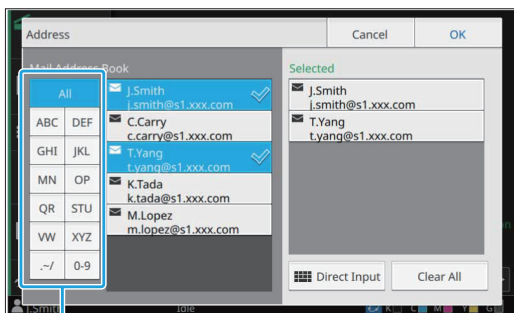

Index

The selected address appears in [Selected].



- You can touch the index to narrow down the list of addresses registered in the address book.
- If you are using an authentication server or external system link, the e-mail address obtained from the LDAP server or the external print server is displayed in [Selected].

3) Touch [OK].



- To send to an address that is not displayed in [Mail Address Book], touch [Direct Input] to register a new address.
- To remove an address from [Selected], you can either clear all addresses by touching [Clear All] or select the address to remove and touch [Clear].
- Touch [Sender] to display the [Sender] screen and enter the sender's name.

■ When you have selected [PC]

The scanned data is saved on a computer on the network.

1) Touch [Destination].

The [Destination] screen is displayed.

2) Select a destination from [PC Address Book].

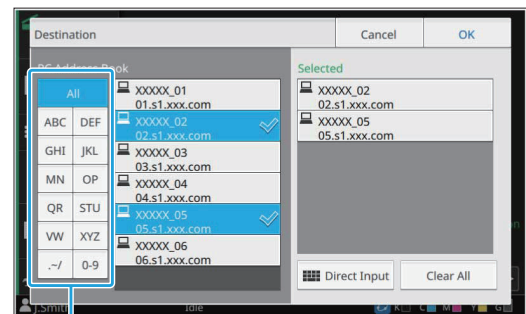

Index

The selected destination appears in [Selected].



- You can touch the index to narrow down the list of destinations registered in the address book.

3) Touch [OK].



- To save data to a computer not listed in [PC Address Book], contact your administrator.
- To remove a destination from [Selected], you can either clear all destinations by touching [Clear All] or select the destination to remove and touch [Clear].
- Touch [Direct Input] to register a new destination. For more information on the destination server, contact your administrator.

4 Change the settings.

Specify the detailed settings for scanning. For more information on the functions that can be configured, see "List of Settings" (p.89).

5 Check the preview display.

1) Touch [Preview before sending].

By touching [Continue] in the [Confirm] screen, the scanning of the original starts and the preview is displayed.

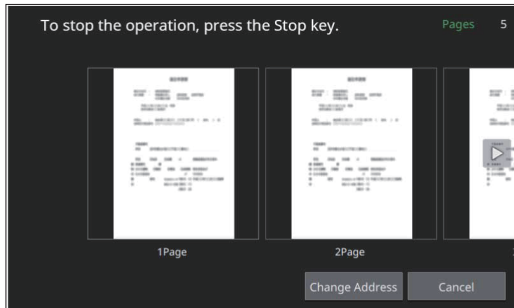

To switch pages, touch [◀] or [▶].

To change the address or destination, touch [Change Address] or [Storage Directory].

6 Press the [Start] key.

The [Scanning] screen is displayed, and scanning of the original starts. The current status is displayed on the screen.

- After the [Confirm] screen is displayed, touch [Close].
The original is scanned and saved.

■ To cancel scanning

1 Press the [Stop] key.

Scanning is stopped and the Scan screen is displayed.



- When you select [Console] to scan data, the scanned data is saved to the internal SSD of the machine.
The saved data can be downloaded to a user's computer using the RISO Console.
See "[Scan] Menu Screen" (p.162) in "RISO Console".
- The storage period for the scanned data is configured by the administrator.



- **RISO KAGAKU CORPORATION is not responsible for the loss of any data on the machine's internal SSD that may occur during the use of the machine. For data protection, it is recommended to back up data in advance.**

List of Settings

The following is a list of settings available in Scan mode.

Setting item	Use this item to:	See
Document Name	View and specify the document name when saving the scanned data.	p.90
Color Mode	Specify the color mode of the data to be scanned.	p.90
Scanning Size	Specify the scanning size for originals to be scanned.	p.91
File Format	Specify the file format for saving the scanned data.	p.91
Duplex/Simplex	Specify the sides of the original to be scanned.	p.91
Scanning Level	Adjust the scanning level.	p.92
Original Orientation	Specify the orientation of the original.	p.92
Resolution	Specify the resolution for scanning originals.	p.92
Mixed Size Original	Scan the original containing the different paper sizes.	p.92
Page Size	Specify the size for saving the scanned data.	p.92
Book Shadow Erasure	Remove shadows that appear in the center of images when an open book is scanned.	p.92
Page Split	Scan double-spread pages and split them into two parts (right and left).	p.93
PIN Code	Assign PIN codes when saving scanned jobs on the internal SSD of the machine.	p.93
Original Type	Select the original type to perform the appropriate image processing and save the scanned data.	p.93
Gamma Correction	Adjust the color balance (CMYK) of the scanned data.	p.93
Image Control	Specify the image processing appropriate for the original.	p.93
Base Color Level	Make the background color (base color) lighter so that the text is easier to read.	p.93
Reproduction Size	Enlarge or shrink the scanned data.	p.94
Scan Job Build	You can scan multiple originals with different settings and combine the jobs into a one job.	p.94
Favorites	Call frequently used settings.	p.95
Check Setting	Check the current settings.	p.95
Preview before sending	Scan and display the original before sending or saving.	p.95
Custom Menu	Register favorites and default settings, and edit the button order. You can register and edit the address books as well.	p.96

Scan Settings

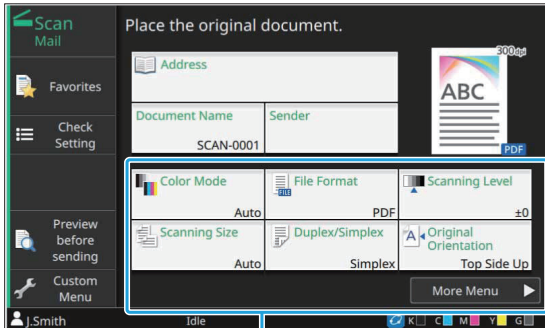

Setting buttons

Document Name

You can view the document name to be used when saving the scanned data.

Touch [Document Name] to set the document name.

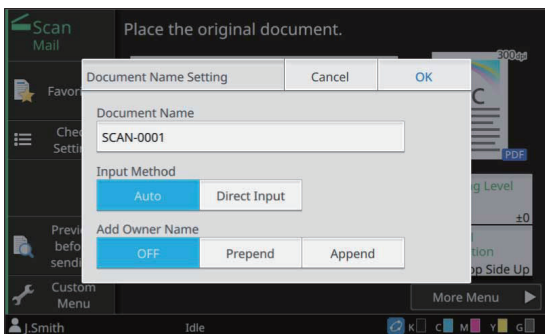

[Document Name]

Among the information specified in [Input Method] and [Add Owner Name], the [Document Name] and [Owner] information is displayed.

[Input Method]

Select [Auto] to set the document name automatically.

Select [Direct Input] to enter a document name of your choice.

If you select [Auto], the document is assigned a name beginning with "SCAN-" and followed by a serial number (0001 to 9999).

[Add Owner Name]

Specify whether to add the owner's name to the document names set up in [Input Method].

Select [OFF] not to add the owner's name. Select [Prepend] to add the owner's name before document names and name them using the following format:

Owner's name - Document name - Page number_Serial number.extension

Example: J.Smith-SCAN-0001-0001_0001.tif

Select [Append] to add the owner's name after document names and name them using the following format:

Document name - Owner's name - Page number_Serial number.extension

Example: SCAN-0001-J.Smith-0001_0001.tif



- The serial number is added only when duplication of a file name occurs.

1 Touch [Document Name].

The [Document Name Setting] screen is displayed.

2 Select an option for [Input Method].

When [Direct Input] is selected, enter a document name and touch [OK].

3 Select whether to add the owner's name.

4 Touch [OK].



- For more information on text input, see "Entering Text" (p.43).
- For [Direct Input], you can use uppercase and lowercase letters.

Color Mode

Select the color mode of the data to be scanned.

[Auto]

The machine automatically determines if the original is in color or black and white. If it is determined that the original is in color, it is converted to RGB data and saved. If it is determined that the original is in black and white, it is converted to black data and saved.

[Full Color]

Originals are converted to RGB data and saved.

[Grayscale]

Color originals and color photos are converted to grayscale data and saved.

[Black]

Originals are saved as black and white (binary) data.

1 Touch [Color Mode].

The [Color Mode] screen is displayed.

2 Select the color mode.

3 Touch [OK].

Scanning Size

Specify the size of the original to be scanned. For more information, see "Scanning Size" (p.63) in "Copying".

File Format

Specify the file format for saving the scanned data. **[PDF], [TIFF], [JPEG], [PDF/A]**

File format	Setting item
[PDF]	<ul style="list-style-type: none"> • [Image Quality] • [Details] <ul style="list-style-type: none"> - [Single Page] - [ZIP] • [Password Setting] <ul style="list-style-type: none"> - [User Password] - [Owner Password]
[TIFF]	<ul style="list-style-type: none"> • [Details] <ul style="list-style-type: none"> - [ZIP]
[JPEG]	<ul style="list-style-type: none"> • [Image Quality] • [Details] <ul style="list-style-type: none"> - [ZIP]
[PDF/A]	<ul style="list-style-type: none"> • [Image Quality]

[Image Quality]

[1: Low], [2], [3], [4], [5: High]

[PDF Password]

Set the user password and owner password.

[Single Page]

Select [ON] to save the scanned data in single pages.

[ZIP]

This option appears when sending the scanned data via e-mail or sending the scanned data to a computer on the network. Select [ON] to compress multiple files of scanned data into a zip file.



- [ZIP] is not displayed when [Console] is selected as the save destination of scanned data. Multiple files of scanned data are always compressed into a zip file and saved to the internal SSD of the machine.

1 Touch [File Format].

The [File Format] screen is displayed.

2 Select the file format to use for saving the scanned data.

3 Change the settings as needed.

4 Touch [OK].



- If [File Format] is set to [PDF], the [ZIP] option will become available when [Single Page] is set to [ON].
- [User Password] that can be entered when [PDF] is selected as the file format is necessary to open the documents later. [Owner Password] is necessary to set the access rights to documents, specifically, the permission to print and edit. The [PIN code] (p.93) for this machine is different from the passwords mentioned above; the PIN code serves the purpose of protecting the scan jobs to be saved in the internal SSD and the print jobs sent from a computer.

Duplex/Simplex

Specify the sides of the original to be scanned.



- [Duplex/Simplex] and [Book Shadow Erasure] cannot be used together. (p.92 "Book Shadow Erasure")

**[Single-sided], [Double-sided]
[Paging Direction]**

Specify whether pages are opened right/left or top/bottom.

[Original Orientation] (p.92 "Original Orientation")

1 Touch [Duplex/Simplex].

The [Duplex/Simplex] screen is displayed.

2 Touch [Original Orientation].

Select [Top Side Up] or [Top Side Left].

3 Specify the sides of the original to scan.

If you have selected [Double-sided], specify the paging direction.

4 Touch [OK].

Scanning Level

Adjust the scanning level.

For more information, see "Scanning Level" (p.65) in "Copying".

Original Orientation

Specify the orientation of the original.

For more information, see "Original Orientation" (p.64) in "Copying".

Resolution

Specify the resolution for scanning originals.

[200 dpi], [300 dpi], [400 dpi], [600 dpi]

1 Touch [Resolution].

The [Resolution] screen is displayed.

2 Specify the resolution.

3 Touch [OK].

Mixed Size Original

Use this option when multiple different original sizes are used in the original. The sizes that can co-exist are "A4-LEF and A3", "B5-LEF and B4", and "Letter-LEF and Ledger".

For more information, see step 2 and subsequent steps under "Mixed Size Original" (p.65) in "Copying".

Page Size

Specify the size for saving the scanned data.

[Auto]

Automatically sets the page size based on the settings for the [Scanning Size] and [Reproduction Size].

[Standard]

Saves the data in the selected standard size.

[Custom]

Saves as a non-standard page sizes registered by the administrator in advance.

[Manual]

Specify the non-standard page size that is not registered and save as this size.

1 Touch [Page Size].

The [Page Size] screen is displayed.

2 Select the page size.

3 Touch [OK].

Book Shadow Erasure

Remove shadows that appear in the center of images when an open book is scanned.

For more information, see "Book Shadow Erasure" (p.66) in "Copying".



- [Book Shadow Erasure] and [Duplex/Simplex] cannot be used together. (p.91 "Duplex/Simplex")

Page Split

Use this option to scan double-spread pages and split them into two parts (right and left).

For more information, see "Page Split" (p.67) in "Copying".

PIN Code

Assign PIN codes when saving scanned jobs on the internal SSD of the machine. The PIN code set here is required when using the RISO Console to download to a computer.

[OFF], [ON]

Enter value (up to 8 characters)

- 1 **Touch [PIN code].**
The [PIN code] screen is displayed.
- 2 **Touch [ON].**
- 3 **Use the numeric keys to enter the PIN code.**
- 4 **Touch [OK].**

Original Type

Select the type of original to perform the appropriate image processing for saving the scanned data.

[Line/Photo]

Select this when the original has both text and photos.

[Line]

Select this when the original has text or illustrations.

[Photo]

Select this when the original has photos.

- 1 **Touch [Original Type].**
The [Original Type] screen is displayed.
- 2 **Select the original type.**

3 Touch [OK].

Gamma Correction

Adjust the color balance of the scanned data. For more information, see "Gamma Correction" (p.72) in "Copying".



- When [Color Mode] has been set to [Grayscale] or [Black], the gamma value can only be adjusted for K. The gamma value cannot be corrected for C-R, M-G, or Y-B. (p.90 "Color Mode")

Image Control

Specify the image processing appropriate for the original.

For more information, see "Image Control" (p.72) in "Copying".

Base Color Level

This function makes the background color (base color) lighter so that the text is easier to read when scanning text originals with a background color or originals printed on colored paper.

For more information, see "Base Color Level" (p.72) in "Copying".

Reproduction Size

Enlarge or shrink the scanned data.

[100% (1:1)]

The data will not be enlarged or shrunk.

[Auto]

Automatically sets the reproduction size based on the settings for the [Scanning Size] and [Page Size].

[Reduce], [Enlarge]

The data is enlarged or shrunk with the selected reproduction size.

Manual

The data is enlarged or shrunk with the user-defined reproduction size.

1 Touch [Reproduction Size].

The [Reproduction Size] screen is displayed.

2 Specify the reproduction size.

To use a user-defined reproduction size, touch [▼] or [▲] to specify the size. You can also enter the number using the numeric keys.

3 Touch [OK].

Scan Job Build

You can scan multiple originals with different settings and combine the jobs into a one job. The scanned data is saved as one document file.

[OFF], [ON]

1 Touch [Scan Job Build].

The [Scan Job Build] screen is displayed.

2 Touch [ON].

3 Touch [OK].

4 Load the original and press the [Start] key.

Scanning of the original starts, and when it is completed, the [Confirm] screen is displayed.

5 Touch [Change Setting].

The scan setting screen is displayed.

6 Change the scan settings as needed.



- You can change only the following scan settings when scanning from the second time.

[Color Mode], [Duplex/Simplex], [Scanning Level], [Original Orientation], [Book Shadow Erasure], [Original Type], [Gamma Correction], [Image Control], [Base Color Level]

7 Load the next original and press the [Start] key.

Scanning of the original starts, and when it is completed, the [Confirm] screen is displayed.

8 Repeat steps 5 to 7 as needed.

If you do not have to change the settings, follow the displayed messages for operation.

9 Touch [Scanned] on the [Confirm] screen.

The scanned data is saved as one document file.

Scan Mode Function Buttons

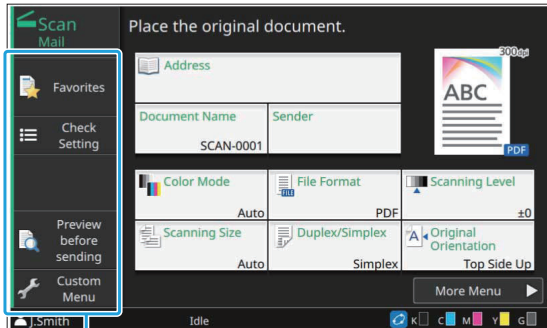

Function buttons

Favorites

Settings can be called whenever necessary. The recommended settings are pre-registered as favorites. Registering frequently used settings can be useful. For more information, see "Favorites" (p.81) in "Copying".

Check Setting

Use this option to check the current settings.

1 Touch [Check Setting].

The [Check Setting] screen is displayed. Check the current settings.

The following setting can be configured from the sub menu:

- Add to Favorites
- Save as Default
- Setting Confirmation Print

2 Touch [Back].

Preview before sending

You can scan and display the original before sending or saving.

1 Touch [Preview before sending].

The [Confirm] screen is displayed.

2 Touch [Continue] to start the scan.

The preview screen is displayed. Check the scan results.

3 Press the [Start] key.

The data is sent or saved.



- You can change the e-mail address with [Change Address] or change the destination where the scanned data will be saved with [Storage Directory].
- When the scanned data contains multiple pages, flick the screen to move between different pages. You can also move between pages by touching [◀] or [▶].

Custom Menu

You can register favorites and default settings, and edit the button order. You can register and edit the address books as well.

Adding to Favorites / Editing Favorites

Use this function to register the settings configured with setting buttons as a favorite. You can register up to 30 favorites. For more information, see "Adding to Favorites" (p.82) and "Editing Favorites" (p.82) in "Copying".



- The following settings cannot be registered as favorites:
 - [Document Name], [PDF Password] in [File Format], [PIN code]

Adding to the Address Book

You can register addresses and destinations in address books.

■ When you have selected [Mail]

1 Touch [Custom Menu].

The [Custom Menu] screen is displayed.

2 Touch [Address Book Add/Edit].

The [Edit Address Book] screen is displayed.

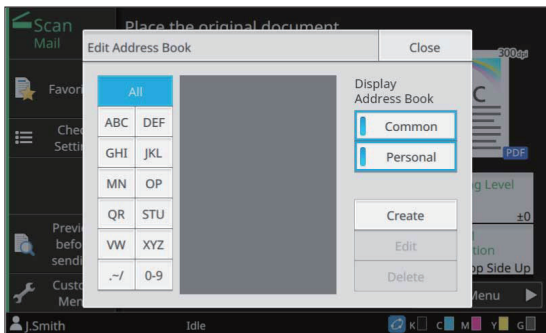

3 Touch [Create].

The [Create] screen is displayed.

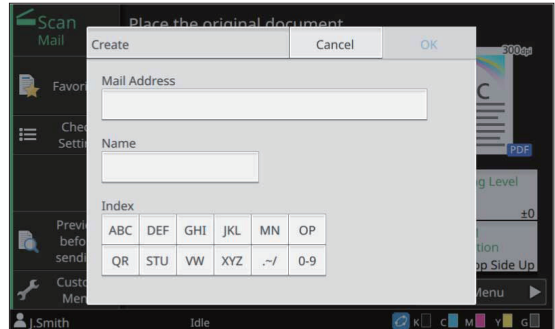

4 Enter an e-mail address.

5 Enter the name of the recipient.

6 Specify the index.

7 Touch [OK].

The address is registered in the address book.

8 Set the [Display Address Book] option.

Specify whether to show a common recipient or an individual recipient on the address book.

9 Touch [Close].

■ When you have selected [PC]

Register a computer as a scanned data destination.

For more information, see "Scan Data Directory" in the "Administrator's Guide".

Editing the Address Book

You can edit the personal addresses and destinations registered in the address books.

■ When you have selected [Mail]

1 Touch [Custom Menu].

The [Custom Menu] screen is displayed.

2 Touch [Address Book Add/Edit].

The [Edit Address Book] screen is displayed.

3 Select an address and touch [Edit].

The [Edit] screen is displayed.

4 Change the settings.**5 Touch [OK].**

The address settings are changed.

6 Touch [Close].**■ When you have selected [PC]**

Change the settings registered as a scanned data destination.

For more information, see "Scan Data Directory" in the "Administrator's Guide".

Deleting an Address or a Destination

You can delete personal addresses and destinations from address books.

■ When you have selected [Mail]**1 Touch [Custom Menu].**

The [Custom Menu] screen is displayed.

2 Touch [Address Book Add/Edit].

The [Edit Address Book] screen is displayed.

3 Select an address and touch [Delete].

The [Confirm] screen is displayed.

4 Touch [OK].

The address is deleted from the address book.

5 Touch [Close].**■ When you have selected [PC]**

Delete the destination that you registered as a scanned data destination.

For more information, see "Scan Data Directory" in the "Administrator's Guide".

Saving / Clearing Defaults

You can register the values entered using the setting buttons as default settings.

For more information, see "Saving as Default" (p.83) and "Clearing Defaults" (p.83) in "Copying".



• The following settings cannot be registered as default settings:

- [Document Name], [PDF Password] in [File Format], [PIN code]

Editing Button Order

This function changes the arrangement of setting buttons.

For more information, see "Editing Button Order" (p.84) in "Copying".

Printing

Connect this machine and a computer to the network to use this machine as a printer.
By using the printer driver, you can send the print data to this machine from a computer.

Overview of Print Operations (Printer Driver) p.100

1. Open the printer driver screen.



2. Change the settings.



3. Click [OK].



4. Click [Print] or [OK].

Overview of Print Operations (Print Mode) p.100

1. Touch [Print] on the [Home1] screen.



2. Select a job.



3. Press the [Start] key.

Printer Driver Settings p.107

This section explains each printer driver setting in detail.

Print Mode Function Buttons p.131

This section explains the functions available in Print mode.



3



Printing

Overview of Print Operations

This chapter describes the basic operations to use this machine as a printer.

Procedure From the Printer Driver

1 Open the printer driver screen.

- 1) Select the print option in the application on the computer.

The print dialog box is displayed.

- 2) Check the printer name and click **[Properties]** or **[Preferences]**.

The button names are different depending on the application.

2 Change the settings.

For more information on the settings that can be configured, see "List of Settings" (p.104).

- To restore all settings on the printer driver screen to their default values, click [Restore Default].
- To restore all settings on the printer driver screen to the values pre-registered by users, click [Restore user settings].



• The **[Original Type]** and **[Paper Type]** settings of the printer driver greatly affect the print quality. Change the settings according to use conditions.

3 Click [OK].

The print dialog box is displayed.



• If the [Collate] check box in the print dialog box is selected, remove the check mark. To print by collating copies, set [Sort] in the [Basic] tab to [Collated].

4 Click [Print] or [OK].

The print data is sent to this machine.



• When using the external system link function, touch [External System Link] on the [Home1] screen and you can print jobs saved on an external system.

For more information, see "External System Link" (p.132).

Procedure From Print Mode



• Depending on the settings configured by the administrator, printing may be performed simply by logging in.

1 Touch [Print] on the [Home1] screen.

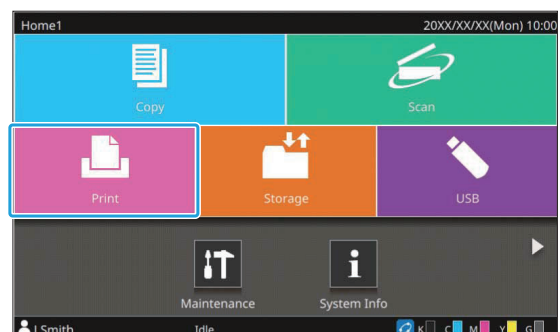

2 Select the job.

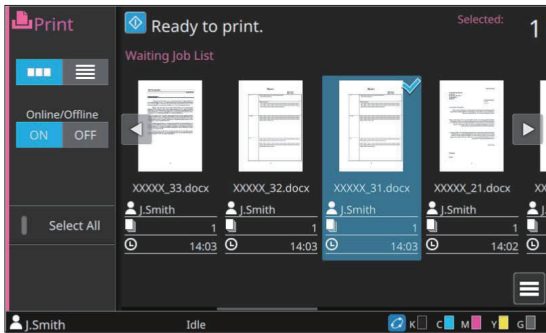

Icons displayed on thumbnails

- : Job with a PIN code
- : Broken job (Broken data or data with problems)
- None** : All other jobs sent from computers

The following setting can be configured from the sub menu:

- Details
- Change Setting
- Delete



- When a job name exceeds the character limit, the part of the job name is omitted and displayed as "...".
- In the following cases, the job name is displayed as "*****".
 - Jobs with the [Hide Job Name] check box selected on the printer driver (p.125 "PIN Code")

3 Press the [Start] key.

The selected job is printed.

■ When printing a job with a PIN code

The PIN code entry screen is displayed. Enter the PIN code using the numeric keys, and touch [Continue].

Changing Settings During Printing

1 Press the [Stop] key.

The [Suspending] screen is displayed.

2 Touch [Change Setting].

The [Change Setting] screen is displayed.

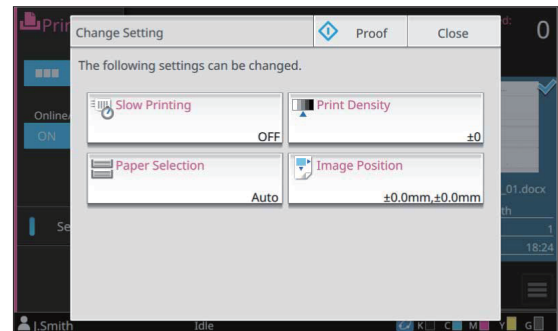

3 Change Settings.

You can change the following settings:

- Slow Printing (p.79 "Slow Printing")
- Print Density (p.65 "Print Density")
- Paper Selection (p.61 "Paper Selection")
- Image Position (p.73 "Image Position")



- If you touch [Proof], only one copy of the page that was being processed when the [Stop] key is pressed is printed.

4 Touch [Close].

5 Touch [Continue].

The print job is resumed with the changed settings applied.

3

Performing Maintenance During Printing

1 Press the [Stop] key.

The [Suspending] screen is displayed.

2 Touch [Maintenance].

The [Maintenance] screen is displayed.

3 Change Settings.

You can change the following settings:

- Print Head Cleaning
- Front Cover Release
- Paper Guide Control
- Online/Offline



- Touch [Online/Offline] to display the [Online/Offline] screen. When this setting is set to [OFF], the machine will not receive jobs from network devices such as computers. This option is convenient when you want to use the machine exclusively without being interrupted by other job.
- For more information on [Print Head Cleaning] and [Front Cover Release], see "Maintenance" (p.240) in the "Appendix".
- If you touch [Proof], only one copy of the page that was being processed when the [Stop] key is pressed is printed.
- If you are using the optional auto-control stacking tray or high capacity stacker, you can adjust the position of the stacking tray with [Paper Guide Control]. For more information, see "Maintenance" (p.240) in the "Appendix".

4 Touch [Close].

5 Touch [Continue].

The print job is resumed with the adjustment applied.

Printer Driver Screen

Settings can be configured from the printer driver screen.

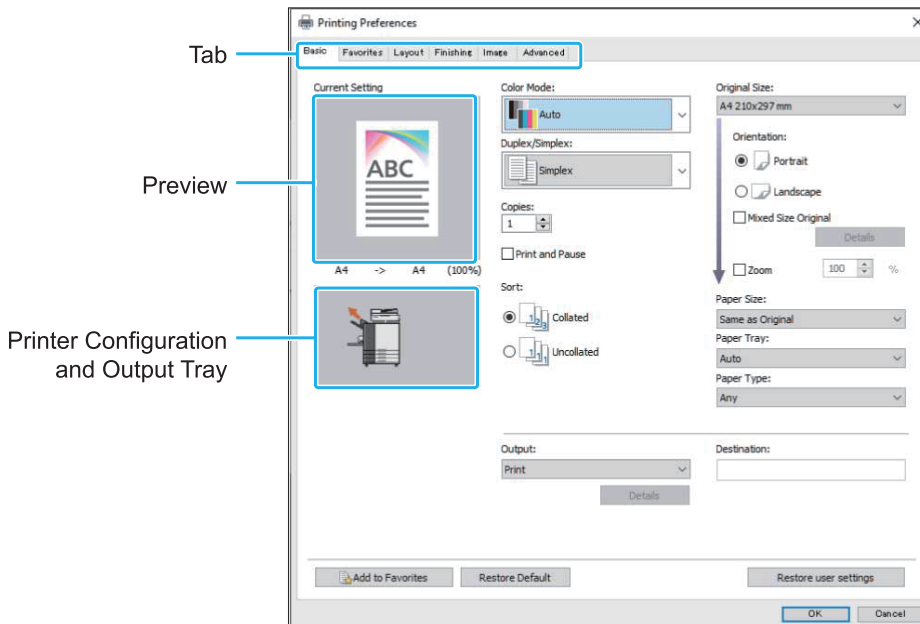

- Tab: Click a tab to switch the screen.
- Preview: Displays a preview image of the document to be printed. The original size, paper size, and enlarge/reduce percentage are displayed under the image.
- Printer configuration and output tray: The connected optional components are displayed as an illustration. The output tray is shown with an arrow.



- Clicking [Add to Favorites] registers the current settings in the Favorites tab.
- Clicking [Restore Default] restores all settings on the printer driver screen to their default values.
- Clicking [Restore user settings] restores all the settings on the printer driver screen to the values pre-registered by users. If the values are not registered, all the settings are restored to their default values. (p.107 "Restore user settings")
- When optional equipment is connected, first configure the settings in [Printer Configuration] under the [Environment] tab to use certain functions. The unavailable functions are grayed out. (p.127 "[Environment] Tab")

List of Settings

List of Printer Driver Settings

The following is a list of the settings that can be configured via the printer driver.

Setting item	Use this item to:	See
Add to Favorites	Register the current settings in the Favorites tab.	p.107
Restore Default	Restore all settings on the printer driver screen to their default values.	p.107
Restore user settings	Restore all settings on the printer driver screen to user setting values.	p.107
[Basic] Tab		
Color Mode	Select a color mode.	p.108
Duplex/Simplex	Specify the sides of the paper that are printed on.	p.108
Copies	Enter the number of copies to print.	p.108
Print and Pause	Stop the machine after printing one set, to check the printing result.	p.109
Sort	Specify the paper output method when printing multiple copies.	p.109
Original Size	Specify the paper size and orientation of the original.	p.109
Mixed Size Original	Print the data containing pages of the different page sizes.	p.109
Zoom	Specify enlargement or reduction of original images before printing, if needed.	p.110
Paper Size	Specify the size of paper for printing.	p.110
Paper Tray	Specify the tray where paper for printing is loaded.	p.110
Paper Type	Specify the type of printing paper.	p.111
Output and Destination	Select the output for the document data sent from a computer. If other than [Print] is selected for [Output], specify the destination by pressing [Details].	p.111
[Favorites] Tab		
List	Check the settings registered as favorites.	p.112
Edit Favorites	Edit the registered favorites.	p.112
Open File	Open a saved favorites file.	p.113
Save in File	Save a favorite as a dedicated file format with the extension ".uds".	p.113
[Layout] Tab		
Combine	Impose multiple pages onto one sheet for printing.	p.113
Image Repeat	Print the same page multiple times on one sheet.	p.114
Booklet	Specify the imposition for middle-binding booklets.	p.114
Poster	Enlarge one page of data and print it onto multiple sheets of paper.	p.115
Watermark	Specify the background watermark to be added to document pages.	p.115
Stamp	Stamp the page number, date, or text in the header or footer.	p.116
Image Position	Specify this when adjusting the print position.	p.117
Rotation	Specify the print orientation.	p.117

Setting item	Use this item to:	See
[Finishing] Tab		
Binding Edge	Print with a binding margin for the pages. Specify the binding edge and the value for the binding margin.	p.118
Staple	Specify the stapling position.	
	When using the optional face down finisher	p.180
	When using the optional multifunction finisher	p.206
Punch	Specify the punch position. (When using the optional multifunction finisher with the punch unit)	p.208
Fold	Configure the paper folding settings. (When using the optional multifunction finisher with the folder unit)	p.208
Booklet Binding	Specify the binding method. (When using the optional multifunction finisher)	p.210
Offset Output	Specify the timing to offset output.	
	When using the optional face down finisher	p.183
	When using the optional high capacity stacker	p.199
	When using the optional multifunction finisher	p.212
Slip Sheet	Specify where to insert slip sheets between printouts.	p.119
Add Cover	Add front and back covers to the printout.	p.119
Output Tray	Select the output tray for printouts.	
	When using the optional auto-control stacking tray or wide stacking tray	p.193
	When using the optional high capacity stacker	p.200
	When using the optional multifunction finisher	p.212
Output Tray Relay	Switch the output tray automatically when the output tray becomes full.	
	When using the optional auto-control stacking tray	p.193
	When using the optional high capacity stacker	p.200
	When using the optional multifunction finisher	p.212
Mail Making	Create enveloped mail with mail form paper and printed materials. (When using the optional Wrapping Envelope Finisher)	p.120
Perfect Binding	Configure the settings for creating booklets with the Perfect Binder. (When using the optional Perfect Binder)	p.120
[Image] Tab		
Original Type	Select which quality setting is given priority for printing according to the original type.	p.120
Print Density	Specify the print density.	p.121
Image Quality	Specify the optimum image processing according to your purpose.	p.121
Line Smoothing	Smooth the outline of text or illustrations.	p.121
Screening	Specify the halftone processing method.	p.122
Gamma Correction	Use this function to adjust the lightness, chroma, contrast, and gamma value of red, green, and blue.	p.122
Barcode Area Definition	Specify the barcode area to make the barcode suitable for reading.	p.122
Envelope Imaging	Specify the image processing for envelope printing.	p.124

Setting item	Use this item to:	See
[Advanced] Tab		
Owner	Specify an owner name of your choice.	p.124
Job Name	Specify a desired job name.	p.125
PIN Code	Add a PIN code to data.	p.125
Job Comment	Add a comment to a job.	p.125
Program	Specify the number of copies by group (such as corporate division or class). You can quickly print exactly the number of copies of the number of sets you need.	p.125
Slow Printing	Decrease the printing speed. This also reduces the amount of noise produced by the machine when printing jobs.	p.126
Blank Page Detection	Suppress printing of any blank pages included in the document.	p.126
Multi-part Paper Printing	Configure this item when printing multiple types of paper such as with a carbon-copying form or slip.	p.127
Version	You can view the printer driver version.	p.127
[Environment] Tab		
Via Shared Printer	Select this option to share the printer driver of the print server to use this machine.	p.127
SNMP Community Name	Specify the community name for SNMP communication.	p.127
Wake On LAN	Specify whether to send a Wake On LAN signal when sending a print job.	p.128
Printer Configuration	Manually specify the information of the optional configuration to the printer driver.	p.128
Custom Paper Entry	Register paper of a size of your choice to the printer driver.	p.128
Folder Entry	Register the destination folder of printing data to the printer driver.	p.130
Get Printer Info	Obtain the information of the optional configuration and automatically configure this to the printer driver.	p.130

List of Print Mode Function Buttons

The function buttons available in Print mode are listed below.

Setting item	Use this item to:	See
View Selection	Select whether to view items as thumbnails or as a list.	p.131
Online/Offline	Switch the network connection status (online/offline) of this machine.	p.131
Select All	Select all of the pending documents that are displayed.	p.131
Details	Use this option to check the current settings.	p.131
Change Setting	Use this option to change job settings.	p.131
External System Link	It appears when [External System Link] is set up by the administrator. You can print or delete jobs, or check amounts.	p.132

Printer Driver Settings

This section describes how to configure the basic settings of the printer driver, such as for color mode, duplex/simplex printing, and paper type.

Common Buttons

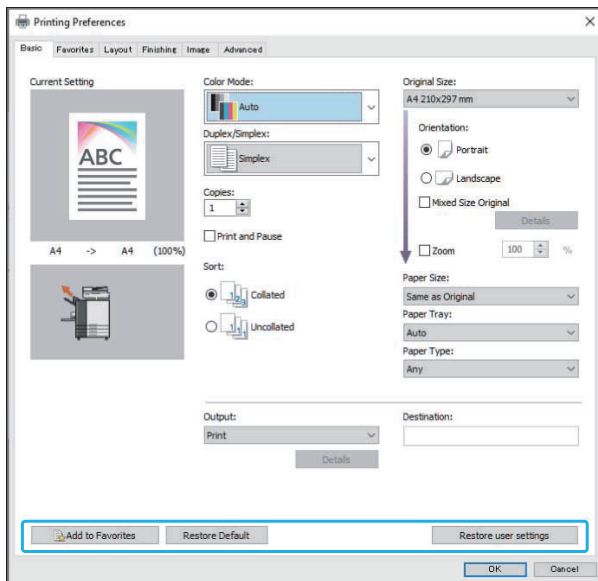

The common buttons are displayed in each tab on the [Printing Preferences] screen.

Add to Favorites

The current settings on the printer driver screen can be saved to retrieve later as needed. Up to 30 groups of settings can be saved.



- You need to have administrative authority for your computer to use the [Add to Favorites] function.

1 Configure the necessary settings on the printer driver screen.

2 Click [Add to Favorites].

The [Add to Favorites] dialog box is displayed.

3 Enter a name.

Enter a name with 1 to 20 characters.

4 Click [Entry].

The settings are saved and displayed in the [Favorites] tab.

Restore Default

Restore all settings on the printer driver screen to their default values.

Restore user settings

Restore all settings on the printer driver screen to user setting values.

Specify the user settings values as follows. Windows 10 is used here as an example.

1 Select the GL series printer from [Start] - [Settings] - [Devices] - [Printers & scanners].

2 Click [Manage] - [Printer properties] screen.

3 Select [Preferences] on the printer driver properties screen.

The [Printing Preferences] screen is displayed.

4 Change the settings as needed.



- The detailed settings specified here are saved to the printer driver. From the next time, you can call up the values preregistered by users just by clicking [Restore user settings].
- The detailed settings from [Properties] or [Preferences] are temporary settings, which are specified by selecting the print option in the application on the computer. The settings are not saved.

- When clicking [Restore user settings] in a state where the user setting values are not set yet after the printer driver is installed, all settings on the printer driver screen are restored to their default values, such as when clicking [Restore Default].

[Basic] Tab

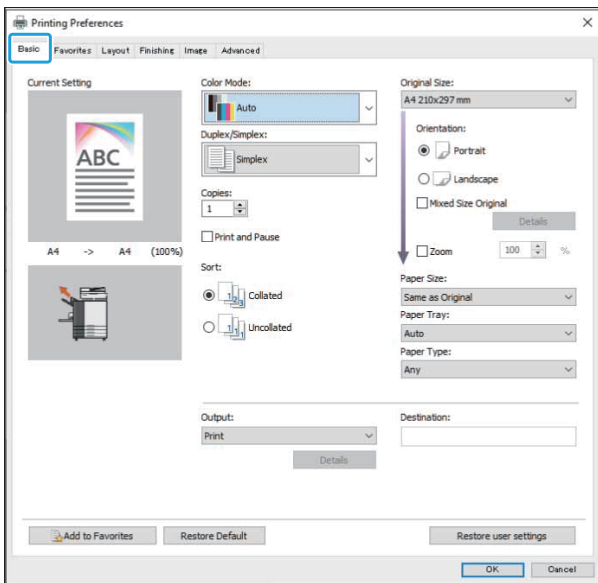

Color Mode

Select a color mode.

[Auto]

The machine automatically reads the color of the document and prints in full color (cyan, magenta, yellow, gray, and black) or black accordingly.

[Full Color]

Select this option to print using five colors (cyan, magenta, yellow, gray, and black).

[Black]

Select this option to print in one color (black) regardless of the colors used in the document.

[Cyan]

Select this option to print in one color (cyan) regardless of the colors used in the document.

[Magenta]

Select this option to print in one color (magenta) regardless of the colors used in the document.

Duplex/Simplex

Specify the sides of the paper that are printed on.

[Simplex]

Data is printed on one side of the paper.

[Duplex (Long Edge)]

Data is printed on both sides of the paper with the long edge as the binding position.

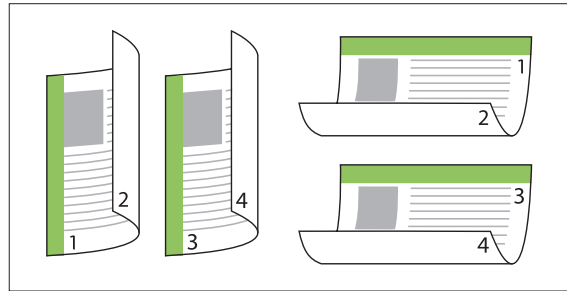

[Duplex (Short Edge)]

Data is printed on both sides of the paper with the short edge as the binding position.

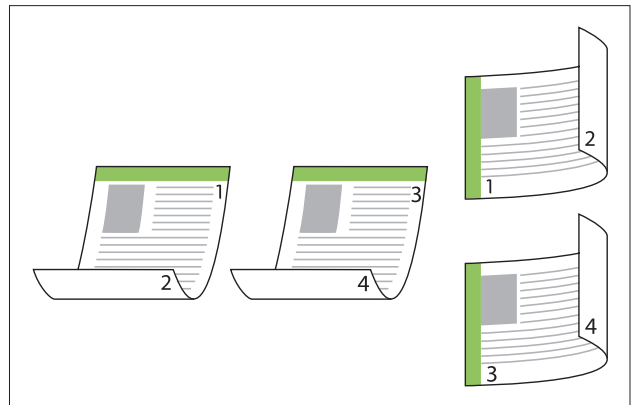

- To print on both sides of the paper with mixed-size documents, specify the binding orientation in the [Mixed Size Original] dialog box.

Copies

Enter the number of copies (1 to 9999) to print.



- When program has been configured, you cannot enter the number of copies.

Print and Pause

When printing a document with a large number of pages or sheets, a page or a set is printed (this page or set is not included in the number of pages specified) for you to check before starting the actual printing. After you check the printout, press the [Start] key on the printer to continue printing. Select the check box to enable this option.



- A printout of your check is output according to the printing method ([Uncollated] or [Collated]) which is selected under [Sort].
- After checking the printout, you can change the settings on the operation panel of the printer. (p.101 "Changing Settings During Printing")

Sort

Specify the paper output method when printing multiple copies.

[Collated], [Uncollated]



- If [Collated] is selected, remove the check mark from [Collate] in the Print dialog box of the application. Documents may not be properly printed if this check box is selected.

Original Size

Specify the paper size and orientation of the document data.

[Orientation]

[Portrait], [Landscape]



- When printing on envelopes, it is recommended that you connect the optional stacking tray and envelope feed kit.
- The list shows the sizes registered in [Custom Paper Entry] in the [Environment] tab. (p.128 "Custom Paper Entry")

■ Specifying a Custom Size

When the document is a non-standard size, select [Custom].

1 Select [Custom] for [Original Size].

The [Custom] dialog box is displayed.

2 Enter the document size.

3 Click [OK].



- The size entered here is only valid when configuring the document size. Registering frequently-used document sizes can be useful. (p.128 "Custom Paper Entry")

Mixed Size Original

Use this option when multiple different original sizes are used in the original data.

If [Mixed Size Original] is enabled, the paper tray that suits the document size will be automatically selected.



- You cannot use the [Mixed Size Original] option with the [Paper Size], [Combine], [Image Repeat], [Booklet], [Binding Edge], [Add Cover], [Poster], [Blank Page Detection], [Form Overlay], or [Multi-part Paper Printing] function. (p.110 "Paper Size", p.113 "Combine", p.114 "Image Repeat", p.114 "Booklet", p.118 "Binding Edge", p.119 "Add Cover", p.115 "Poster", p.126 "Blank Page Detection", p.228 "Form Overlay", p.127 "Multi-part Paper Printing")
- When using this function with duplex printing, duplex printing is only applied when the size of the front and back of the document is the same. (If the size is not the same, the back of the page is left blank.)
- When printing the mixed-size document data after [Mixed Size Original] is disabled, all pages are printed in the size of the first page.

■ Using This Function with Duplex Printing

When using this function with duplex printing, you can set the binding position for each paper size. Select the [Mixed Size Original] check box and click [Details] to display the [Mixed Size Original] dialog box. Select the binding position for each size.



- For setting [Mixed Size Original] in [USB] - [Load], select the document on the [USB] - [Load] screen on the operation panel, and then touch [Print Setting] in the sub menu - [More Menu] - [Mixed Size Original] - [ON]. (p.147 "Printing a Document Saved on a USB Flash Drive")

[Larger Page]

[Long Edge], [Short Edge]

[Smaller Page]

[Long Edge], [Short Edge]

[Rotate Larger Page 180 Degrees]

Rotates the larger pages 180 degrees.



- [Larger Page] means A3, B4 (Ledger, Legal), and Tabloid; [Smaller Page] means other sizes.
- Some applications do not allow you to rotate the larger pages to the desired orientation. In this case, select the check box to rotate the print orientation 180 degrees.

Zoom

Specify the enlarge/reduce ratio of the original. Select the [Zoom] check box and enter the enlarge/reduce ratio in the range of 50% to 200%. If you do not select [Zoom], the enlarge/reduce ratio is automatically selected based on the [Original Size], [Paper Size] and page imposition settings.

Paper Size

Specify the size of paper for printing.



- You cannot use [Paper Size] and [Mixed Size Original] at the same time. (p.109 "Mixed Size Original")
- When printing on envelopes, it is recommended that you connect the optional stacking tray and envelope feed kit.
- The list shows the sizes registered in [Custom Paper Entry] in the [Environment] tab. (p.128 "Custom Paper Entry")

■ Specifying a Custom Paper Size

When the paper is a non-standard size, select [Custom].

1 Select [Custom] for [Paper Size].

The [Custom] dialog box is displayed.

2 Enter the size of the paper.

3 Click [OK].



- The size entered here is only valid when configuring the document size. Registering frequently-used paper sizes can be useful. (p.128 "Custom Paper Entry")

Paper Tray

Specify the input tray to use for printing.



- When you use the [Multi-part Paper Printing] function, [Paper Tray] is set to [Auto]. (p.127 "Multi-part Paper Printing")

[Auto]

The paper tray is selected automatically according to the [Paper Type] and [Paper Size] settings.

[Standard Tray]

The paper loaded in the standard tray is used for printing.

[Feed Tray 1], [Feed Tray 2], [Feed Tray 3], [Additional Tray]

The paper loaded in the specified tray is used for printing.



- If [Auto] is selected, but the actual paper loaded in the tray does not match the [Paper Size] and [Paper Type] settings (or the same paper is loaded but the tray selection setting is not set to [Auto Selection]), an error occurs and the job is not printed. Select [Any] in [Paper Type]. (p.111 "Paper Type")
- You can use the RISO Console to confirm the paper size and paper type loaded in the printer paper tray. See "[Consumables] Screen" (p.159) in "RISO Console".
- When using the optional high capacity feeder, [High Capacity Feeder] is displayed in place of [Standard Tray].
- [Additional Tray] is displayed when using the optional additional tray.

Paper Type

Select the type of printing paper.
You can print the document data with adjustments, such as coloration and amount of ink, as well as image processing to suit the selected paper type.

[Any]

Select this option to enable automatic selection of paper type according to printer settings.

[Plain]

[IJ Paper], [Matt Coated]

Select one of these when using IJ paper or similar paper.

[High-quality]

[Card-IJ]

This item can be configured when selecting [Standard Tray] or [High Capacity Feeder] with [Paper Tray].



- The machine selects the color profile that is most suitable for your paper type. To print with the appropriate color balance, match the printer paper settings with the loaded paper.
- If [Any] is selected, the paper type and image processing may not be compatible when communication with the printer is not established or the printer's paper settings are changed after sending a print job.

■ What is the Color Profile?

Colors on a monitor or other display are expressed in terms of the three primary colors of light (RGB: red, green, and blue), while colors printed with ink are expressed in terms of the three primary colors (CMY: cyan, magenta, and yellow).

Because CMY, which is used to express the colors printed on paper, has fewer colors than RGB, which is used to express colors displayed on a computer monitor, the printer cannot print the colors exactly as seen on the monitor. For this reason, it is necessary to use a special method to convert RGB colors to CMY colors so as to reproduce nearly the same colors or natural colors. This method is called "color management", and the conversion table is called a "color profile".

With color management, the printer automatically selects several types of color profiles to obtain the optimal color according to the combination of the original image and paper being used.



- This machine uses color profiles created and edited based on the ColorSet technology licensed from Monotype Imaging K.K.

Output and Destination

Specify whether to print the data sent from a computer or save it to a folder on the printer. You can also save the data to a USB flash drive as a PRN file, or create a file to use in the Barcode Area Definition Software.

[Print]

Prints the data.

[Storage]

You can save the document data to a folder on the machine as a PRN file.

[Print & Storage]

Saves the original data in a folder on the machine and prints it.

[Save to USB Drive]

You can save the document data to a USB flash drive as a PRN file. Even if you do not have a network environment, you can print by connecting a USB flash drive to the machine.

[Save as a File]

A PRN file is created to be used in the Barcode Area Definition Software.



- **Do not remove the USB flash drive until saving is finished. During data saving, a printer icon appears in the taskbar shown on the computer. When saving is completed, the printer icon disappears. Make sure that the icon has disappeared before removing the USB flash drive.**



- The data saved in a folder on this machine can be printed from the [Storage] - [Load] screen (p.135), or from "[Storage] Menu" (p.164) on "RISO Console".
- The data saved on a USB flash drive can be printed from the [USB] - [Load] screen by connecting the USB flash drive to the machine. You can also save the data to this machine by copying it to a folder on the machine. (p.153 "Copy to Folder")
- PRN files are output by the printer driver in a format that was developed exclusively for RISO KAGAKU CORPORATION. PRN files cannot be opened using printers or applications by other manufacturers.
- The computer user name is added, as the owner, to the data saved to a folder on the machine.

■ Destination Folder Settings

The folders registered in [Folder Entry] on the [Environment] tab are displayed in [Destination]. (p.127 "[Environment] Tab")

1 In [Output], select [Print & Storage], [Storage], or [Save to USB Drive].

2 Click [Details].
The [Output] dialog box is displayed.

3 In the [Destination] pull-down menu, select the directory of the original data.

The available folders are displayed in the [Destination] list.

4 Click [OK].
The selected folder name is displayed in the [Destination] field.

[Favorites] Tab

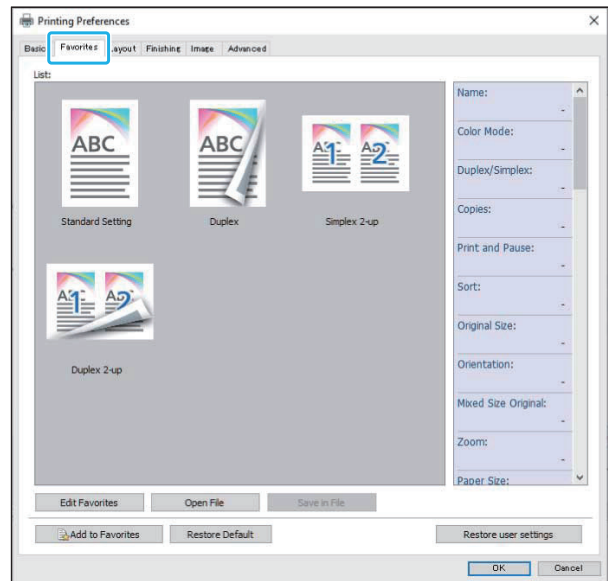

List

The printer driver settings registered as favorites are displayed in a list. The recommended settings are pre-registered as favorites. Click a favorite to display the details of the selected favorite settings in a list. The print settings are changed according to the selected favorite settings.

Edit Favorites

Edit the registered favorites.

[Current Setting]

The selected favorite settings are displayed.

[List]

The registered favorites are displayed.

[Up], [Down]

You can change the display order for the favorites in [List] using these keys.

[Rename]

You can change the registered name of a favorite. Enter a new name with 1 to 20 characters.

[Delete]

You can delete a favorite.

Open File

You can call and use printer driver settings saved in a computer.

- 1 **Click [Open File].**
The [Open] dialog box is displayed.
- 2 **Select a file on the computer.**
- 3 **Click [Open].**
The loaded settings are displayed in [List].

Save in File

You can save the settings that are registered as a favorite to a computer. It is useful to save settings to a computer when, for example, you want to share the settings among multiple users or reinstall the printer driver.

- 1 **Select the settings in [List] that you want to save to a computer.**
- 2 **Click [Save in File].**
The [Save As] dialog box is displayed.
- 3 **Specify the destination folder and file name.**
- 4 **Click [Save].**
The selected settings are saved.

[Layout] Tab

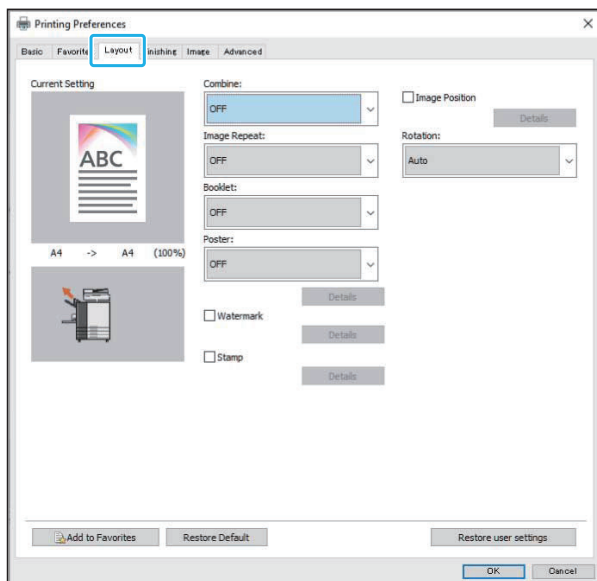

Combine

This function imposes continuous pages onto one sheet for printing.



- You cannot use the [Combine] function with the [Mixed Size Original], [Image Repeat], [Booklet], [Poster], or [Blank Page Detection] function. (p.109 "Mixed Size Original", p.114 "Image Repeat", p.114 "Booklet", p.115 "Poster", p.126 "Blank Page Detection")

[OFF],
 [2 Pages: Left to Right], [2 Pages: Right to Left],
 [2 Pages: Top to Bottom], [2 Pages: Bottom to Top],
 [4 Pages: Left Top to Right], [4 Pages: Left Top to Bottom],
 [4 Pages: Right Top to Left], [4 Pages: Right Top to Bottom],
 [8 Pages: Left Top to Right], [8 Pages: Left Top to Bottom],
 [8 Pages: Right Top to Left], [8 Pages: Right Top to Bottom]

Select the number of pages per sheet and the order in which they are laid out.

Example: If [4 Pages: Left Top to Bottom] is selected

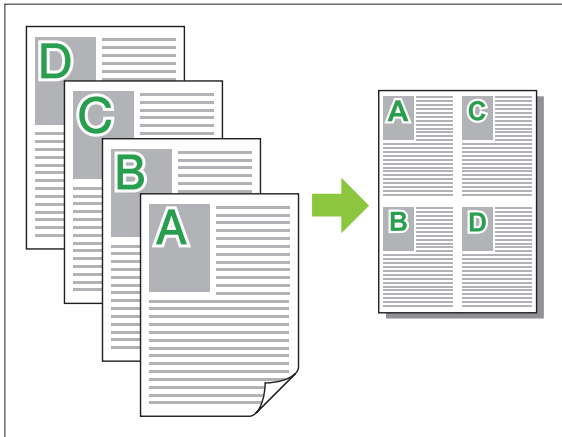

Image Repeat

The same page is printed multiple times on one sheet.



- You cannot use the [Image Repeat] function with [Mixed Size Original], [Combine], [Booklet], or [Poster] function. (p.109 "Mixed Size Original", p.113 "Combine", p.114 "Image Repeat", p.118 "Binding Edge", p.126 "Blank Page Detection", p.115 "Poster")

[OFF], [2 Pages], [4 Pages], [8 Pages]
Select the number of pages per sheet.

Example: If [4 Pages] is selected

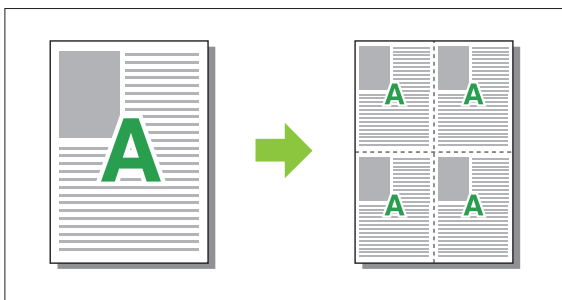

Booklet

Continuous multiple pages are imposed and printed to create a middle-binding booklet after duplex printing.



- You cannot use the [Booklet] function with the [Mixed Size Original], [Combine], [Image Repeat], [Binding Edge], [Blank Page Detection], or [Poster] function. (p.109 "Mixed Size Original", p.113 "Combine", p.114 "Image Repeat", p.118 "Binding Edge", p.126 "Blank Page Detection", p.115 "Poster")
- When using the optional multifunction finisher, you can configure [Booklet Binding] (fold/center binding with staple) in the [Finishing] tab.
For more information, see "Booklet Binding" (p.210) in "Optional Equipment".

[OFF], [Left to Right], [Right to Left], [Top/Bottom]

Specify the layout order. The [Left to Right] and [Right to Left] options appear when [Portrait] is selected for [Original Size].

The [Top/Bottom] option appears when [Landscape] is selected for [Orientation] under [Original Size].

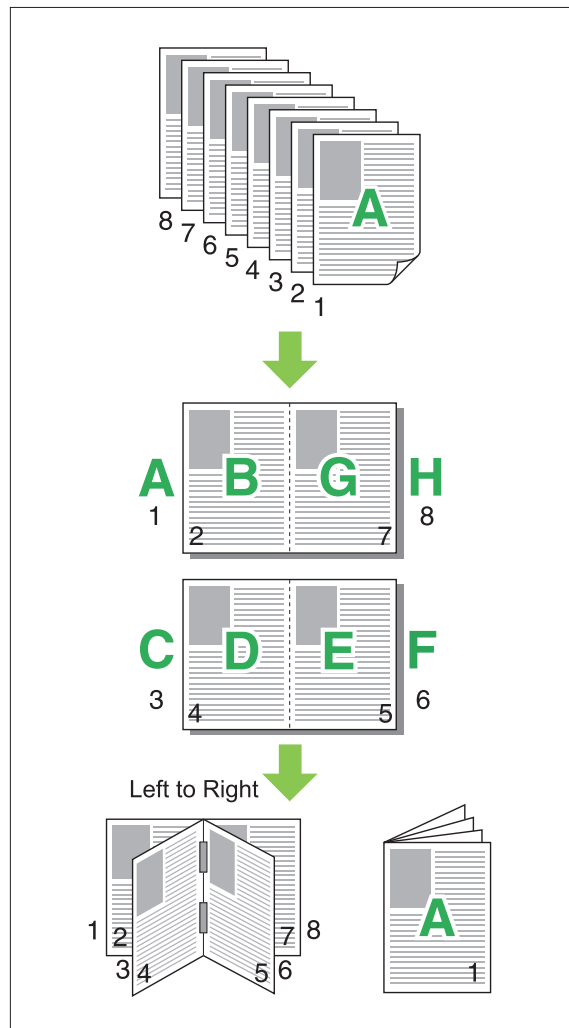

Poster

Enlarge one page of image data and divide it onto multiple sheets of paper for printing.



- The areas not to be printed are added on the four sides of the paper printed with Poster function. When sticking the sheets of printed paper together to form a poster, paste them over these areas so that the joint areas become inconspicuous.
- You cannot use the [Poster] function with the [Mixed Size Original], [Combine], [Image Repeat], [Booklet], [Watermark], [Stamp] or [Image Position] function.
(p.109 "Mixed Size Original", p.113 "Combine", p.114 "Image Repeat", p.114 "Booklet", p.115 "Watermark", p.116 "Stamp")

**[2 divisions (1x2)], [4 divisions (2x2)],
[9 divisions (3x3)], [16 divisions (4x4)]**

Specify the number of sheets of paper onto which you want to divide the original.

Click [Details] to display [Poster] dialog box.

The selected settings are immediately applied to the preview image.

[Print range]

[All], [Specified page]

Select the print range. You can also specify the page to be printed in [Specified page]. The page to be printed is highlighted in blue color in the preview image.

[Center alignment]

When the check box is selected, the image is formed at the center when the printed sheets of paper are stuck together.

When the check box is not selected, the image is formed at the top left corner when the printed sheets of paper are stuck together.

[Print the cutting line]

When the check box is selected, the cutting lines are printed on the four corners of each page.

[Margin]

You can specify the margin between 0 mm and 20 mm (25/32").



- Printing without margins cannot be performed. Margins are always added around the edges of the paper.
- Depending on the margin setting value, a blank page may be printed out and the part of the image may be omitted.
- The image quality may be rough-grained when enlarging the image data. Be sure to select [Fine] for [Image Quality] and [High] for [Line Smoothing]. For more information, see "Image Quality" (p.121) and "Line Smoothing" (p.121).

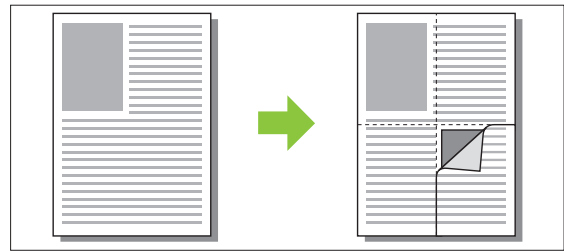

Watermark

Add a watermark of the desired size and in the desired position on printouts.

Select the [Watermark] check box and click [Details] to display the [Watermark] dialog box.

Select a character string from the character string list and configure the necessary settings.

The selected settings are immediately applied to the preview image.



- You need to have administrative authority for your computer to add or delete a watermark character string.

■ Text

[Select Text]

**[Confidential], [Important], [Circulation],
[Reference], [Urgent], [Copying Prohibited]**

[Add]

You can also add a character string of up to 63 characters long.

Click [Add] under the character string list, and enter the character string in the [Add] dialog box.

[Delete]

Select the character string to delete from the list, and click [Delete].

You cannot delete the default character strings (Confidential, Important, Circulation, etc.).

[Input Text]

[Apply]

You can also print a character string of up to 63 characters long. However, this cannot be registered with the list of character strings. You will need to enter the string of characters each time. Click [Apply] to apply the entered character string to the preview image.

■ Preview

The image according to the settings is displayed. You can also use the mouse pointer to adjust the position in the preview image.

■ Apply Page

[All Pages], [First Page]

■ Text Decoration

[Font]

Select a font and style.

[Size]

Specify the character string size.

[Color]

Specify the color of the character string. Click [Others] to select a color from the color palette of the operating system.

[Transparency]

Specify the transparency of the character string. A higher transparency means that the print data will be more visible in the background of the watermark character string.

[Frame]

[Not Installed], [Circle], [Rectangle], [Double Rectangle]

Select a frame for the watermark.

■ Print Position

[Text Angle]

[Horizontal (0 deg)], [Vertical (90 deg)], [Vertical (270 deg)], [Oblique (45 deg)], [Oblique (315 deg)], [Custom] (0-360 deg)

Select the angle of the text. You can also enter the numerical angle of the text.

[Print Position]

[Center], [Top Left], [Top Center], [Top Right], [Center Right], [Bottom Right], [Bottom Center], [Bottom Left], [Center Left], [Custom]

Select the print position of the watermark. You can also enter the values for the positions in the vertical and horizontal directions.

Stamp

Stamp the page number, date, or text in the header or footer.

Select the [Stamp] check box and click [Details] to display the [Stamp] dialog box. Use the tab screens to configure the settings.

[Page], [Date], [Text]



- You cannot print different types of stamps in the same position.
- When using this function with [Combine] or [Image Repeat], the page number and date are stamped on each page of the copy paper, not per page of the original document. When using this function with [Booklet], the page number and date are stamped on each booklet page.

■ Page

To print the page stamp, select [ON] on the [Page] tab screen.

[Top Left], [Top Center], [Top Right], [Bottom Left], [Bottom Center], [Bottom Right]

Select the page stamping position.

[Transparency]

Select the [Transparency] check box to have the date stamped on top when the stamp area and images overlap.

Remove the check mark to create a white space by removing images in the stamp area, and then stamp the date in that white space.

[Start Number]

Enter the start number for the page stamp.

[Stamp Start Page]

Enter which page to start the page stamps. To print no page stamp on the cover, set [Stamp Start Page] to "2" (For duplex printing, set this to "3" depending on the case).

[Font]

Select a font and style.

[Size]

Specify the size of the text for the page stamp.

■ Date

To print the date stamp, select [ON] on the [Date] tab screen.

[Top Left], [Top Center], [Top Right], [Bottom Left], [Bottom Center], [Bottom Right]

Select the date stamping position.

[Transparency]

Select the [Transparency] check box to have the date stamped on top when the stamp area and images overlap.

Remove the check mark to create a white space by removing images in the stamp area, and then stamp the date in that white space.

[Apply Page]

Specify the first page on which to print the date stamp.

[All Pages]: The date will be printed on all pages.

[First Page]: The text will be printed on the first page only.

[Stamp Date]

Configure the date to use for the date stamp.

[Today]: The date set on the computer is printed.

[Specify Date]: The date specified in the text box is printed.

[Font]

Select a font and style.

[Size]

Specify the size of the text for the date stamp.

■ Text

To print a text stamp, select [ON] on the [Text] tab screen.

[Top Left], [Top Center], [Top Right], [Bottom Left], [Bottom Center], [Bottom Right]

Select the text stamping position.

[Transparency]

Select the [Transparency] check box to have the date stamped on top when the stamp area and images overlap.

Remove the check mark to create a white space by removing images in the stamp area, and then stamp the date in that white space.

[Apply Page]

Specify the pages on which to print the text stamp.

[All Pages]: The text will be printed on all pages.

[First Page]: The text will be printed on the first page only.

[Text]

The text specified in the text box is printed.

[Font]

Select a font and style.

[Size]

Specify the size of the text for the text stamp.

Image Position

Adjust the printing position of images.



- You can move the image position up to 20 mm (25/32") in all directions (up, down, left, right).
- When performing duplex printing, the front and back sides can be adjusted separately.

Select the [Image Position] check box and click [Details] to display the [Image Position] dialog box. Enter a value in the data entry field of the direction that you want to adjust.

[Front Side], [Back Side]

Enter a value for [Horizontal] or [Vertical].

[Reset]

All values are reset to zero.

Rotation

Specify the print orientation.

[Auto], [0 deg], [90 deg], [180 deg], [270 deg]

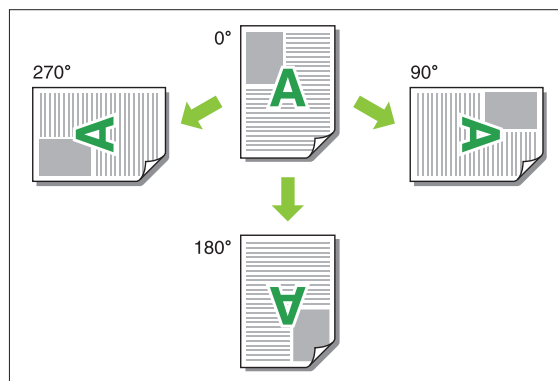

When [Auto] is selected, the print orientation is set automatically according to the orientation of the document data and the orientation of the paper loaded in the paper tray. For normal use, select [Auto].



- To align the print orientation with an envelope or other paper with a fixed feeding direction, specify the angle of rotation.
- [Auto] may be the only option available depending on the document size, the size and orientation of the paper loaded in the tray, and other settings.

[Finishing] tab

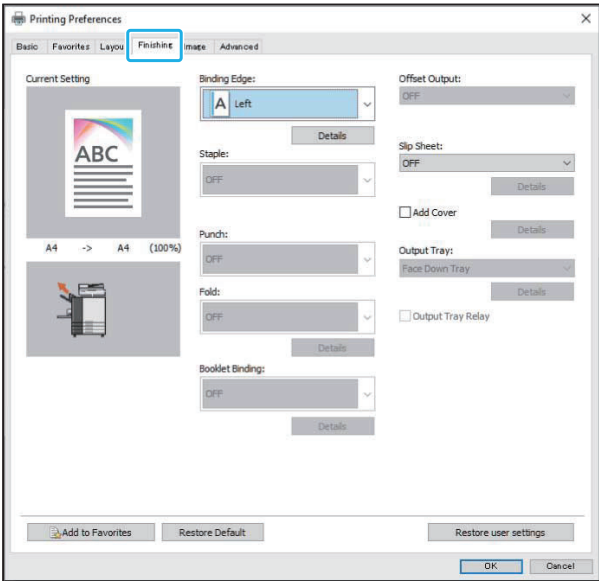

Binding Edge

Specify the binding margin.



- You cannot use the [Binding Edge] function with the [Mixed Size Original] or [Booklet] function. (p.109 "Mixed Size Original", p.114 "Booklet")

[Left], [Right], [Top]

■ Binding Margin Settings

Select the binding edge and click [Details] to display the [Binding Edge] dialog box. Specify the margin width. Select the [Auto Reduction] check box to automatically reduce the printed image to fit the paper in cases where the margin width does not allow for the original-scale printed image to fit into the paper.

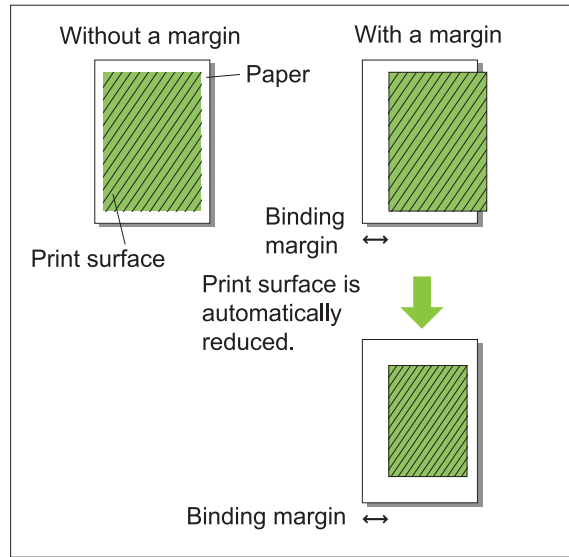

Staple

If you are using the optional face down finisher or multifunction finisher, the staple function is available at the specified position.

For more information, see the following:

- When using the face down finisher (p.180 "Staple")
- When using the multifunction finisher (p.206 "Staple")

Punch

If you are using the optional multifunction finisher with the punch unit, you can configure holes to punch.

For more information, see "Punch" (p.208) in "Optional Equipment".

Fold

When using the optional multifunction finisher, you can configure how the paper is folded.

For more information, see "Fold" (p.208) in "Optional Equipment".

Booklet Binding

When using the optional multifunction finisher, you can configure the binding method. For more information, see "Booklet Binding" (p.210) in "Optional Equipment".

Offset Output

If you are using the optional face down finisher, high capacity stacker, or multifunction finisher, you can configure how the output position is offset. For more information, see the following:

- When using the face down finisher (p.183 "Offset Output")
- When using the high capacity stacker (p.199 "Offset Output")
- When using the multifunction finisher (p.212 "Offset Output")

Slip Sheet

Use this function to insert a slip sheet between print units when printing multiple copies. You can stamp a number or letter on slip sheets.

[OFF]
Slip sheets are not inserted.

[Between Sorts]
A slip sheet is inserted between sets, based on the unit specified in [Sort].

[Between Jobs]
A slip sheet is inserted between print jobs.

Select whether to insert a slip sheet between sorts or between jobs, and click [Details] to display the [Slip Sheet] dialog box. Select the tray for slip sheets and specify the text to stamp.

Slip Sheet Tray Selection

[Standard Tray], [Feed Tray 1], [Feed Tray 2], [Feed Tray 3], [Additional Tray]

- When using the optional high capacity feeder, [High Capacity Feeder] is displayed in place of [Standard Tray].
- [Additional Tray] is displayed when using the optional additional tray.

Number on Slip Sheet

The text is printed at the bottom (within approx. 5 mm (7/32") of the edge) or top (within approx. 5 mm (7/32") of the edge) of the sheet.

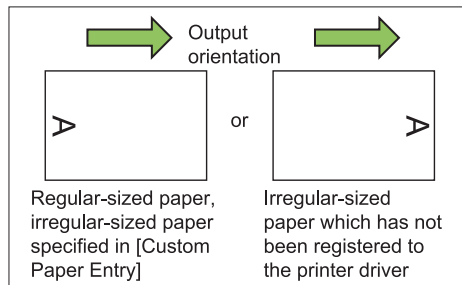

[OFF]
Nothing is stamped.

[1 2 3 ...]
Numbers are stamped on slip sheets in numerical order (1, 2, 3...). (Up to 9999)

[A B C...]
Letters are stamped on slip sheets in alphabetical order (A, B, C...Z, AA, AB, AC...). (Up to ZZZ)

Add Cover

Specify this option to add a front and/or back cover. Paper is added from a specified tray before or after the data to be printed. Specify this option to use colored paper or paper that differs from the pages to be printed.



- You cannot use [Add Cover] and [Mixed Size Original] at the same time. (p.109 "Mixed Size Original")

Select the [Add Cover] check box and click [Details] to display the [Add Cover] dialog box. Select [Add Front Cover] or [Add Back Cover], or both check boxes, and specify the tray for the selected cover.

[Add Front Cover]
This option inserts a cover sheet before the first page.

[Add Back Cover]
This option inserts a cover sheet after the last page.

[Select Front Cover Tray], [Select Back Cover Tray]
[Standard Tray], [Feed Tray 1], [Feed Tray 2], [Feed Tray 3], [Additional Tray]



- Specify the trays loaded with paper to be used for the covers.
- The side in which the paper is loaded varies depending on the tray.
[Select Front Cover Tray]
Standard tray / Optional additional tray: Load the paper with the first page facing up. Feed tray: Load the paper with the first page facing down.
[Select Back Cover Tray]
Standard tray / Optional additional tray: Load the paper with the first page facing down. Feed tray: Load the paper with the first page facing up.
- When loading preprinted paper, it is recommended that one set be printed to check that the orientation matches that of the other pages to be printed.
- When using the optional high capacity feeder, with [Select Front Cover Tray] and [Select Back Cover Tray], [High Capacity Feeder] is displayed in place of [Standard Tray].
- [Additional Tray] is displayed when using the optional additional tray.

Output Tray

If you are using the optional stacking tray, high capacity stacker, or multifunction finisher, you can select the trays for output of the printed materials. For more information, see the following:

- When using the stacking tray (p.193 "Output Tray")
- When using the high capacity stacker (p.200 "Output Tray")
- When using the multifunction finisher (p.212 "Output Tray")

Output Tray Relay

When using the auto-control stacking tray, high capacity stacker, or multifunction finisher, the output tray switches automatically when the tray that is being used becomes full.

For more information, see the following:

- When using the auto-control stacking tray (p.193 "Output Tray Relay")
- When using the high capacity stacker (p.200 "Output Tray Relay")
- When using the multifunction finisher (p.212 "Output Tray Relay")

Mail Making

When using the optional Wrapping Envelope Finisher, you can create enveloped documents with mail form paper and printed materials. For more information, see the user's guide for the Wrapping Envelope Finisher.

Perfect Binding

When using the optional Perfect Binder, you can configure the setting for creating booklets with perfect binding. For more information, see the user's guide for the Perfect Binder.

[Image] Tab

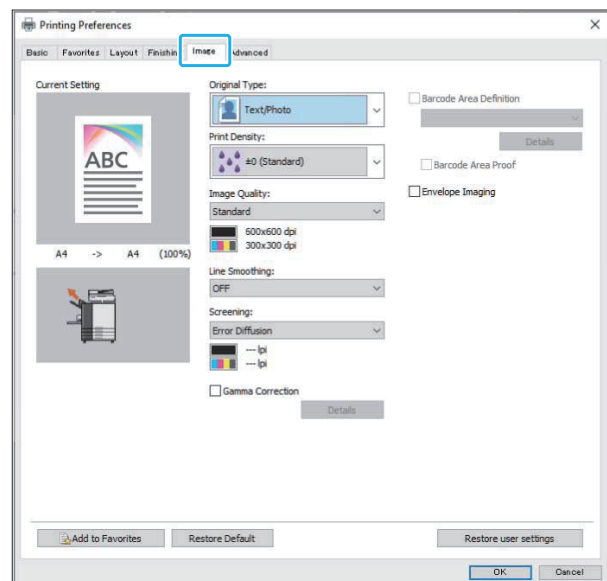

Original Type

Select which quality setting is given priority for printing according to the original type.

[Text/Photo]

This option processes text with sharp rendering and image data with more natural colors.

[Text/Illustration]

This option processes text with sharp rendering and illustrations with vivid colors.

[Fine Text/Lines]

This option processes fine text and lines with sharp rendering.



- When the [Color Mode] is [Black], [Cyan], or [Magenta], [Text/Illustration] cannot be selected.

Print Density

Specify the print density.

[-3] (light), **[-2]**, **[-1]**, **[±0 (Standard)]**, **[+1]**, **[+2]**, **[+3] (dark)**

Image Quality

Specify the optimum image processing according to your purpose.

[Standard]

Suitable for documents and other originals with text.

[High Chromogenic]

Use this option to print with vivid colors.

[Fine]

This option is suitable for printing photo and text in high quality.

[CMY Print]

The printout is made without using gray ink and black ink. This improves the fixing property of the printout and prevents ink from rubbing off onto other materials.

[Processing Speed Priority]

The printout is made at 300 x 300 dpi resolution without using gray ink. This option reduces the image processing load.

[Draft]

This option reduces ink consumption during printing. When less ink is used, print density is reduced and the neutral colors become uneven.



- Printing will take longer if you select [Fine].
- [Envelope Imaging] cannot be configured when [Draft] is set. (p.124 "Envelope Imaging")

Line Smoothing

This function supplements the intermediate colors of drawing and background colors in outline sections of text or illustrations (line drawing) to make the outlines smoother.

You can select either of two different image processing types.

[OFF]

Select this option if you do not want to perform line smoothing.

[Low]

Select this option to make outlines smoother.

This option is appropriate for printing the data that do not need fine processing.

[High]

Select this option to make outlines smoother and make fine characters and lines clearer.

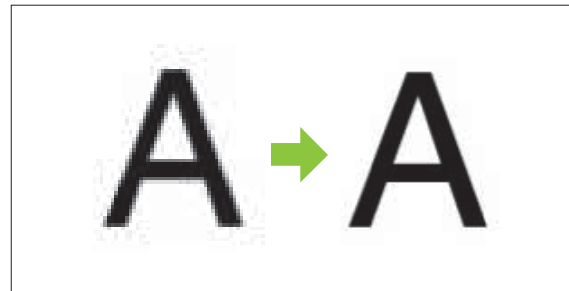

(Image)



- The line smoothing function's image processing is inversely proportional to processing speed (print speed). The higher the image quality, the lower the print speed.

Screening

Specify the halftone processing method. Halftone is a processing method that varies the density and size of ink dots printed on paper to give the appearance of continuous color gradation when only using a limited number of inks.

[Error Diffusion]

This function expresses gradation by changing the density of dots. The higher the density, the darker the gradation. The lower the density, the lighter the gradation.



[Dot Process (140 lpi)], [Dot Process (200 lpi)]
(When [Color Mode] is set to [Black])

[Dot Process (70 lpi)], [Dot Process (100 lpi)]
(When [Color Mode] is set to other than [Black])
This function expresses gradation by changing the size of the dots. The larger the dots, the darker the gradation. The smaller the dots, the lighter the gradation.

A dot process of 100 lines per inch provides more detailed images than of 70 lines per inch.

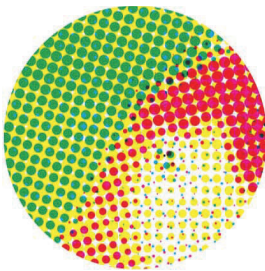

70 lines per inch

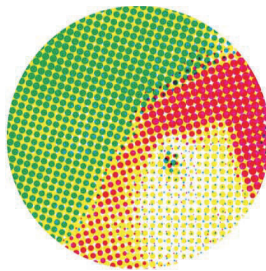

100 lines per inch

(Enlarged image)

Gamma Correction

Use this function to adjust the lightness, chroma, contrast, and gamma value of red, green, and blue.



- [Gamma Correction] and [Blank Page Detection] cannot be used together. (p.126 "Blank Page Detection")

Select the [Gamma Correction] check box and click [Details] to display the [Gamma Correction] dialog box. Enter a value between -25 and +25 for each item.

[Lightness]

The smaller the value, the darker (blackish) the color. The larger the value, the brighter (whitish) the color.

[Chroma]

The smaller the value, the more washed-out the color. The larger the value, the more vivid the color.

[Contrast]

Adjusts the ratio of brightness to darkness. The smaller the value, the lower the contrast. The larger the value, the higher the contrast.

[Red], [Green], [Blue]

Corrects the gamma value of each color. The smaller the value, the weaker the color. The larger the value, the stronger the color.



- When printouts are yellowish, lower the values of red and green. To adjust other colors, consult with the administrator for configuration.

Barcode Area Definition

This function makes the print density of the specified barcode area suitable for reading.

[Barcode Area Definition]

Select the check box, and select an area definition file to print from the pull-down menu.

[Details]

Click [Details] to display the [Barcode Area Definition] dialog box.

[Density Correction]

You can adjust the print density of the specified barcode area.

[-3] (light), [-2], [-1], [Standard], [+1], [+2], [+3] (dark)



- [-3] (light), [+1], [+2], [+3] can be selected when [Image Quality] is set to [Processing Speed Priority]. (p.121 "Image Quality")

[Barcode Area Proof]

On printouts with shaded barcode areas, you can check whether the barcode area definition is out of alignment, and whether letters or illustrations overlap the 1 mm (3/64") margin around the barcode.



- When [Barcode Area Definition] is specified, [Draft] and [CMY Print] in [Image Quality] cannot be configured. (p.121 "Image Quality")

■ Creating a Barcode Area Definition File

To use the [Barcode Area Definition] function, use the Barcode Area Definition Software beforehand to create a CSV file that specifies the barcode print area for registering in the printer.

For more information on installing the Barcode Area Definition Software, specifying the barcode area, and registering the definition file in the printer, see "Overview of the Barcode Area Definition Software" (p.168).

■ Checking the Barcode Area Definition

Select the [Barcode Area Proof] check box and click [OK] to output a printout for checking. Check whether the specified area is out of alignment. If the specified area is not printed in the desired position, use the Barcode Area Definition Software again to re-configure the barcode area.

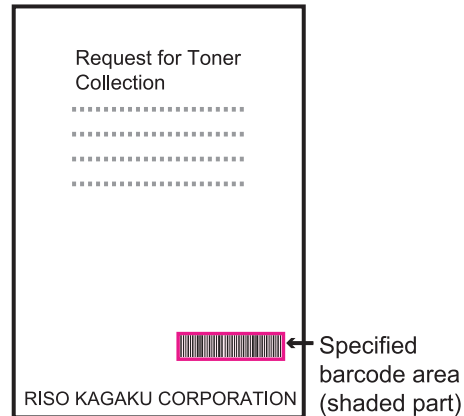

Correct Specification

- Surround the barcode with a margin of 1 mm (0.04") or more.



- The specified area cannot be smaller than the barcode.



- The specified area must be aligned with the barcode.



- Do not include another object with the barcode.
Any non-black image inside the specified area is printed out white (disappears).



- With [Barcode Area Proof], the barcode in the specified area is printed with magenta when the [Color Mode] is [Full Color] or with the configured color when a different color mode is selected.
- The type of targeted barcodes is one-dimensional. If the barcodes are two-dimensional (e.g., QR code), you do not need to perform this setting.

- If you print using different resolutions for the application that created the original and the printer, barcodes may not be able to be read correctly even using this function.

Barcode printing barcode originals

Once the barcode area is correctly defined, print the document.



- In the area specified as the barcode area, regardless of the color of the original, the base color is white, and the barcode color is black.

- 1 Open the printer driver from the Print menu on the document application screen.
- 2 On the [Image] tab screen, select the [Barcode Area Definition] check box.
- 3 Select the barcode area definition file from the pull-down menu.
- 4 Click [OK].
The print density of the barcode area is appropriately configured before printing.



- Follow the procedure below to set the settings of frequently used barcode originals as the default settings. This will enable you to print barcodes without performing necessary settings each time, making barcode printing easy.

How to Register to the Default

- 1 Select the printer that you use from [Start] - [Settings] - [Devices] - [Printers & scanners].
- 2 Click [Manage] - [Printing Preferences] to open the printer driver screen and display the [Image] tab screen.

3 Configure the settings necessary for barcode printing, and click [Apply].

The "barcode area definition" file is registered as the default settings. From now on, you can perform barcode printing just by selecting the printer driver.

Envelope Imaging

Prevent blur and small stains during envelope printing. Select the [Envelope Imaging] check box.



- [Envelope Imaging] cannot be configured when [Draft] is set for [Image Quality]. (p.121 "Image Quality")

[Advanced] Tab

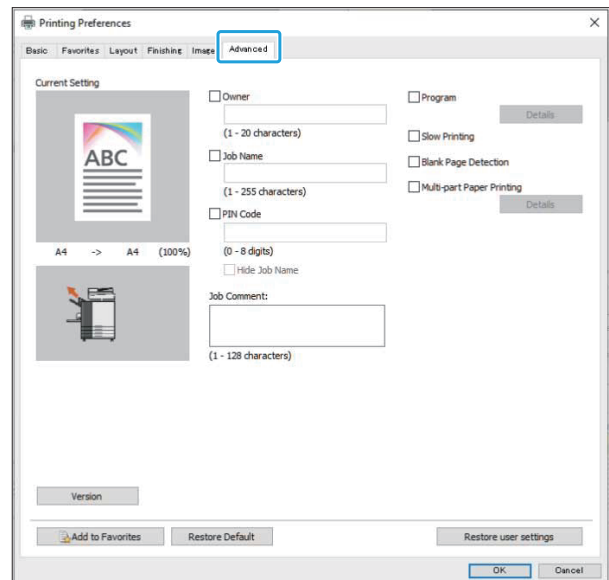

Owner

You can enter an owner's name of your choice. Select the [Owner] check box to enter the owner's name.

Job Name

You can enter a job name of your choice. Select the [Job Name] check box to enter the job name.

PIN Code

You can set a PIN code when printing a document you do not want others to view. A PIN code-protected job will not be printed unless you enter the PIN code using the operation panel on the printer. Select the [PIN Code] check box and enter a PIN code. When [Hide Job Name] is selected, the job name is displayed as "*****" on the operation panel of the printer and on the RISO Console.



- Manage the PIN code so as not to forget it. **Users without administrative authority cannot delete jobs from a list for which the PIN code is unknown. Contact the administrator to delete these jobs.**

Job Comment

You can enter a comment for printer users. You can display job comments using the operation panel of the printer or the RISO Console.

Program

When you want to distribute the different number of copies by group (such as corporate division or classes), you can quickly print the necessary number of copies by only one operation. For example, to distribute a document to each division in an office, you can print the number of copies per division. Select the [Program] check box and click [Details] to display the [Program] dialog box. Specify the number of copies and sets for each group.



- [Program] and [Multi-part Paper Printing] cannot be used at the same time. (p.127 "Multi-part Paper Printing")

■ Entering the Number of Copies and Sets

Group [01G] - [60G]

Set a program in which one group is combined with both the numbers of copies and sets. You can configure up to 60 groups.

[Copies]

Enter the number of copies to print. You can configure up to 9,999 copies.

[Sets]

Specify how many sets you need to print based on the number of one set of copies entered in. You can configure up to 99 sets.

<Setting Example>

The following describes how to configure the settings when printing by dividing copies by the number of employees per division.

Division	General Affairs	Accounting	Management
No. of employees	10	6	10
Necessary number of copies	10	6	10

Divide groups into division units and specify the numbers in [Copies] and [Sets] respectively for each group. Enter the number of employees in [Copies]. To print one set of copies specified, enter 1 in [Sets].

Division	Printer Driver Settings		
	Group	Copies	Sets
General Affairs	01G	10	1
Accounting	02G	6	1
Management	03G	10	1

In addition, when multiple groups have the same necessary number of copies, you can group them together as one group by increasing the number of sets. In this case, both the general affairs and management divisions have the same number of copies, so that you can configure the settings as follows to print by dividing copies by corporate division.

Division	Printer Driver Settings		
	Group	Copies	Sets
General Affairs, Management	01G	10	2
Accounting	02G	6	1

■ Sort

Specify whether to print page by page or in sets. **[Uncollated]**, **[Collated]**

■ Slip Sheet (Program)

Insert a slip sheet to separate printouts into specified units.

[OFF]

Slip sheets are not inserted.

[Between Sets]

Slip sheets are inserted between sets.

[Between Groups]

Slip sheets are inserted between groups.

■ Slip Sheet Tray

[Standard Tray], **[Feed Tray 1]**, **[Feed Tray 2]**, **[Feed Tray 3]**, **[Additional Tray]**



- When using the optional high capacity feeder, [High Capacity Feeder] is displayed in place of [Standard Tray].
- [Additional Tray] is displayed when using the optional additional tray.

■ Number on Slip Sheet

When this check box is selected, numbers are stamped on the slip sheets.

If [Between Sets] is selected, the group number and set number are stamped.

If [Between Groups] is selected, the group number is stamped.

■ Offset Output (Program)

If you are using the optional face down finisher, high capacity stacker, or multifunction finisher, you can configure this item. For more information, see the following:

- When using the face down finisher (p.183 "Offset Output (Program)")
- When using the high capacity stacker (p.200 "Offset Output (Program)")
- When using the multifunction finisher (p.212 "Offset Output (Program)")

Slow Printing

You can slow down the printing speed. This also reduces the amount of noise produced by the machine when printing jobs.

Blank Page Detection

The print data is printed excluding the blank pages.



- "Blank pages" means pages that are normally output without anything printed on them. Pages are printed even if they have only a header or footer but no main text.
- You cannot use the [Blank Page Detection] function with the [Mixed Size Original], [Combine], [Booklet], or [Gamma Correction] function. (p.109 "Mixed Size Original", p.113 "Combine", p.114 "Booklet", p.122 "Gamma Correction")

Multi-part Paper Printing

Configure this item when printing multiple types of paper such as with a carbon-copying form or slip. Select the [Multi-part Paper Printing] check box and click [Details] button to display the [Multi-part Paper Printing] dialog box. Under [Feed Trays], select the tray to use and add this to the [Feed Tray Order] list. As printouts are made by feeding paper in order from the tray at the top of the [Feed Tray Order] list with the [Multi-part Paper Printing] function, use the [Up] and [Down] buttons to change the order of the paper trays in the priority list.



- You cannot use the [Multi-part Paper Printing] function with the [Mixed Size Original] or [Program] function at the same time. (p.109 "Mixed Size Original", p.125 "Program")
- When [Multi-part Paper Printing] is selected, [Paper Tray] is set to [Auto]. (p.110 "Paper Tray")
- If you are using the optional face down finisher or multifunction finisher and have configured [Staple]/[Punch], the [Multi-part Paper Printing] function will not be possible unless the size and direction of the paper is the same in all trays specified with [Feed Tray Order].

Version

Check the version and color profile of the printer driver, as well as the model name of the printer.

[Environment] Tab

When using the printer driver for the first time or adding optional equipment to the machine, you must configure the environment settings on the [Environment] tab under printer properties.

To display the [Environment] tab, go to [Device] - [Printers & scanners] from the [Start] menu, select the printer that you use, and right-click [Manage] - [Printer properties].

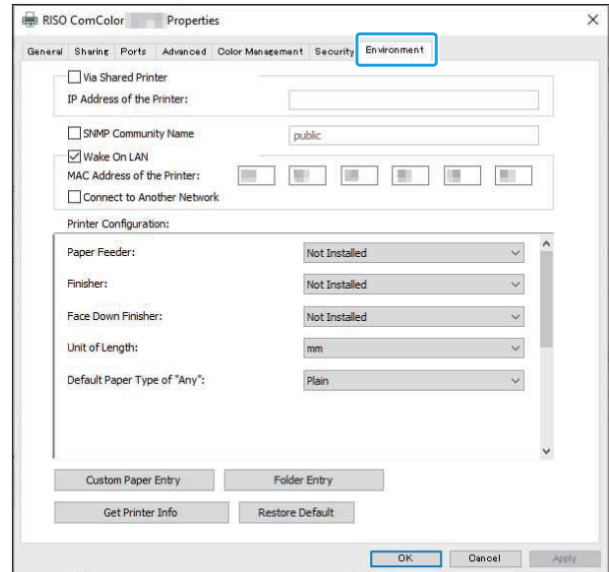

- Clicking [Restore Default] restores all settings on the tab to their default values.

Via Shared Printer

Select this option to share the printer driver of the server computer to use this machine. Place a check in [Via Shared Printer] and under [IP Address of the Printer], enter the IP address of this machine configured to be shared with the print server by using up to 39 characters. You can check the IP address of the machine on the [System Info] - [Machine Info] screen on the operation panel.

SNMP Community Name

Specify the community name required for obtaining the machine's information from the computers with SNMP communication. Place a check in [SNMP Community Name] and use the text box to enter 1 to 32 characters as the community name for SNMP communication.



- If a check is not placed in [SNMP Community Name], the community name for SNMP communication will be set to "public".

- Alphanumeric characters (uppercase/lowercase) and the following symbols can be entered in the text box for [SNMP Community Name]:
., / : ; @ [\] ^ _
- It will not be possible to obtain information from the machine if the SNMP community names are different between the machine and the printer driver. If you have made changes to the SNMP community name with the machine, you must make sure to also apply the change to the printer driver.

Wake On LAN

Specify the Wake On LAN setting to be used for waking up the machine via LAN.
If you try to print in a network environment where Wake On LAN communication is not enabled, the printer does not wake up automatically. Select [Get Printer Info] and click [Apply] to obtain the MAC address and display it in [MAC Address of the Printer].
To enter the MAC address manually, select the [Wake On LAN] check box and enter the MAC address in [MAC Address of the Printer] and select [Connect to Another Network].
[Connect to Another Network]
Normally, leave this check box unselected. Select this option when the printer's and computer's network segments are different.



- Despite configuring [Wake On LAN], depending on the network settings it may not be possible to start the printer. Contact your network administrator for details.

Printer Configuration

Normally, the optional equipment configuration information is automatically obtained from the printer when installing the printer driver. The information obtained from the machine is displayed in [Printer Configuration]. The obtained information can also be changed manually.



- The information displayed on the screen varies depending on the optional equipment connected.
[Default Paper Type of "Any"], [External System Link], and [End-User-Defined Characters (EUDC) Printing] are not configured automatically.

■ Configuring the Printer Configuration Manually

You can change the optional equipment configuration that you obtain from the printer. Specify the following settings manually:

[Paper Feeder]

Select the type of feeder that is connected to this machine.

[Finisher]

Select the type of finisher that is connected to this machine.

[Face Down Finisher]

Select whether there is a face down finisher.

[Unit of Length]

Select whether to display the length in [mm] or [inch].

[Default Paper Type of "Any"]

Select the paper type to use when [Paper Type] under the [Basic] tab on the printer driver screen is set to [Any].

[External System Link]

Set this option to [ON] to enable and [OFF] to disable external system link.

[End-User-Defined Characters (EUDC) Printing]

Set this option to enable or disable the print processing for end-user-defined characters (EUDC).



- The machine changes the color profile according to the paper type. (p.111 "Paper Type") Even when the paper is not specified, in order to print with an appropriate color profile, it is necessary to configure the type of paper with [Default Paper Type of "Any"]. Make your selection based on the administrator's recommendation.

Custom Paper Entry

Register up to 99 non-standard paper sizes. The sizes registered here are displayed in [Original Size] and [Paper Size].

■ Configuring the Paper Size Automatically

You can use this option when the paper size is already registered in the printer.

- 1 **Click [Custom Paper Entry].**
The [Custom Paper Entry] dialog box is displayed.
- 2 **Click [Get Printer Info].**
The information of the paper size registered in the printer is displayed.
- 3 **Click [Close].**
The paper size information is saved.

■ Configuring the Paper Size Manually

- 1 **Click [Custom Paper Entry].**
The [Custom Paper Entry] dialog box is displayed.
- 2 **Enter the paper width and length.**

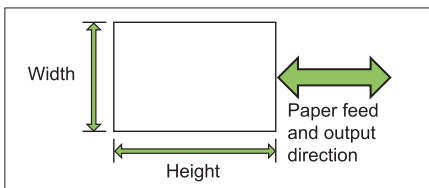

When the multifunction finisher is connected, see "Multifunction Finisher FG20 (Optional)" (p.249) in the "Appendix".

- 3 **Enter a name for the paper size.**
Enter a name with 1 to 30 characters.
- 4 **Click [Add] to register the paper size.**
- 5 **Click [Close].**
The paper size information is saved.

■ Saving the Paper Size to a Computer

You can save the registered paper size to a computer.
It is useful to save settings to a computer when, for example, you want to share the registered paper size among multiple users or reinstall the printer driver.

- 1 **Click [Custom Paper Entry].**
The [Custom Paper Entry] dialog box is displayed.
- 2 **Select the paper size to save from the list box.**
- 3 **Click [Save in File].**
- 4 **Specify the destination folder and file name.**
- 5 **Click [Save].**
The selected paper size is saved.

■ Reading a Paper Size from a Computer

You can read and use a paper size saved to a computer.

- 1 **Click [Custom Paper Entry].**
The [Custom Paper Entry] dialog box is displayed.
- 2 **Click [Open File].**
- 3 **Select the file with the paper size setting on the computer.**
When the computer is configured to display the file extension, the file for the paper size will have an extension of .udp displayed.
- 4 **Click [Open].**
The read paper sizes are displayed in the list on the [Custom Paper Entry] dialog box.

■ Deleting a Paper Size

- 1 **Click [Custom Paper Entry].**
The [Custom Paper Entry] dialog box is displayed.
- 2 **Select the paper size to delete from the list box.**

3 Click [Delete].

The selected paper size is deleted.

Folder Entry

You can register in the printer driver the folders to save the print data to. The shared folders and personal folders registered here are displayed as print data destination folders in [Output] under the [Basic] tab on the printer driver screen. (p.111 "Output and Destination")



- If folder information cannot be obtained from the printer, the shared folders are displayed as "Shared folder 1" to "Shared folder 30".

■ Configuring a Folder Entry

1 Click [Folder Entry].

The [Folder Entry] dialog box is displayed.

2 Click [Get Printer Info].

The information of shared folders registered in the printer is displayed in [Shared Folder in the Printer].

3 Select the folder to add to [Registered Folder] and click [Add ->].

4 Set the personal folder.

For personal folders, by selecting the [Use Personal Folder] check box, personal folders will be displayed under [Destination] on the [Basic] tab.

5 Click [OK].

6 Click [OK].

Get Printer Info

Obtain the information of the optional configuration of the printer and automatically configure this to the printer driver. For more information, see "Printer Configuration" (p.128).

Print Mode Function Buttons

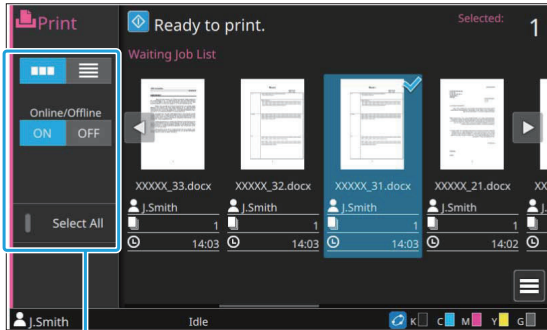

Function buttons

View Selection

You can select whether to view the waiting jobs as thumbnails or as a list.

[☰]: View as thumbnails

[☰]: View as list

Online/Offline

You can switch the network connection status (online/offline). When this setting is set to [OFF], the machine does not accept print orders from computers.

Specify this setting when you want to use the machine exclusively without being interrupted by other job.

[OFF], [ON]



- When this setting is set to [OFF], [✖] is displayed. (p.32 "[Home1] Screen")
- If the user does not return [Online/Offline] to [ON] after printing their job, the setting automatically returns to [ON] in the following cases:
 - When auto reset is executed (The auto reset timing is set by the administrator.)
 - When you log out

Select All

Touch this to select all pending jobs.
Touch this again to cancel the selection.

Details

Select the job in [Waiting Job List] and touch [Details] in the sub-menu. Click this button to view the setting values for the selected job.

Change Setting

To check job settings, select the job and touch [Change Setting] in the sub menu.

Paper Selection

Select a paper tray.

You can also change the tray settings (paper size, paper type, double-feed check, and auto selection).

For more information, see "Paper Selection" (p.61) in "Copying".

Slow Printing

You can slow down the printing speed. This also reduces the amount of noise produced by the machine when printing jobs.

For more information, see "Slow Printing" (p.79) in "Copying".

Print Density

You can adjust the print density.

For more information, see "Print Density" (p.65) in "Copying".

Image Position

Adjust the printing position of images.
For more information, see "Image Position" (p.73) in "Copying".

Check Setting

1 Touch [Check Setting].

The [Check Setting] screen is displayed. Check the current settings.

The following setting can be configured from the sub menu:

- Setting Confirmation Print

2 Touch [Back].

External System Link

When using an external system link, you can print jobs saved on an external system.



- Depending on the settings of the administrator, the [External System Link] button may be displayed with a different name on the [Home1] screen.
- The operating procedures may differ depending on the external system being used. Contact your administrator for details.

1 Touch [External System Link] on the [Home1] screen.

When connected to an external system, a list of the documents saved on the external system will be displayed.

2 Select a document and press the [Start] key.

You can save the scanned data in folders for printing as necessary.

Overview of Storage Operations (Save) p.134

1. Load the original.



2. Select [Storage] - [Save] on the [Home1] screen.



3. Select a folder to save the data to.



4. Touch [Save Document] to change the settings.



5. Press the [Start] key.

Overview of Storage Operations (Load) p.135

1. Select [Storage] - [Load] on the [Home1] screen.



2. Select a folder.



3. Select a document.



4. Enter the number of copies using the numeric keys.



5. Press the [Start] key.

Storage Mode Function Buttons p.140

This section explains the functions available in Storage mode.



4



Storage

Overview of Storage Operations

This section explains the basic operations of the storage mode.

Saving the Data to a Folder

You can save the scanned data to a folder.

1 Load the original.

For more information on the types of originals that can be used, see "Originals" (p.22).

■ In the ADF

1) Load the original in the ADF.

Align the originals and place them face up.

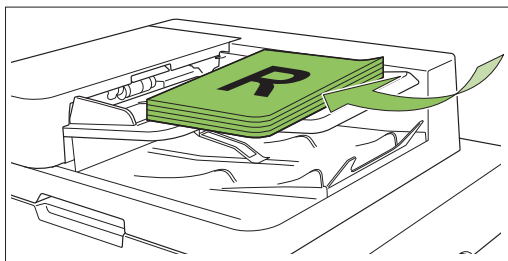

2) Slide the original guides to match the width of the originals.

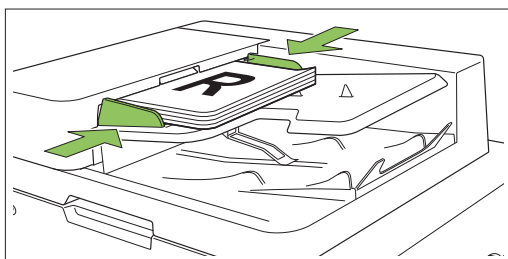

■ On the Platen Glass

1) Open the original cover.

2) Load the originals.

Load the original face down on the glass. Align the corner of the original with the upper-left corner of the glass.

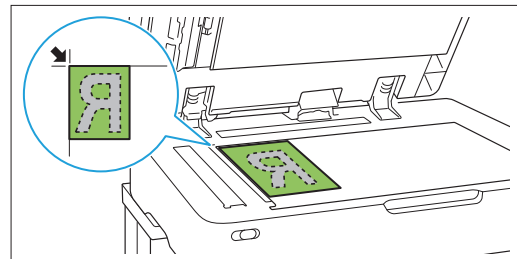

3) Close the original cover.



• Open and close the original cover gently.

2 Select [Storage] - [Save] on the [Home1] screen.

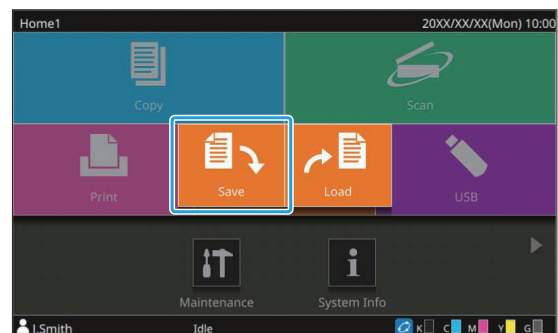

3 Select a folder to save the data to.

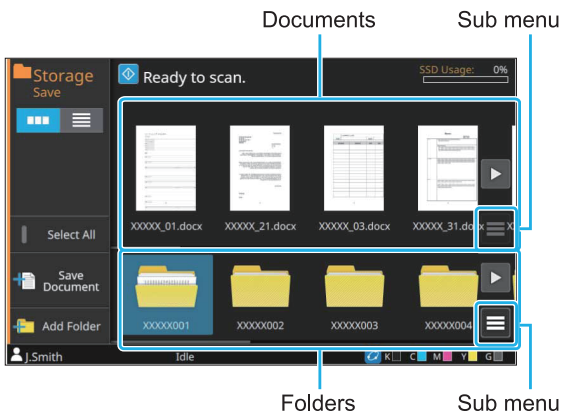

The list of folders shows the personal folder and the shared folders for which use is allowed by the administrator.

The following settings can be configured from the sub menu:

- Change Color
- Rename

The list of documents shows the documents that are saved in the selected folder.

The following settings can be configured from the sub menu:

- Details
- Rename
- Delete

4 Touch [Save Document].

Specify the detailed settings for saving the document.

For more information on the functions that can be configured, see "List of Settings in [Storage] - [Save]" (p.137).

5 Press the [Start] key.

Printing a Document in a Folder

You can print documents that are saved in a folder.

1 Select [Storage] - [Load] on the [Home1] screen.

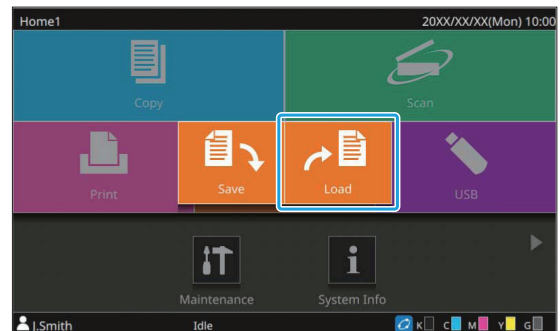

2 Select the folder you wish to use and select the document you wish to print.

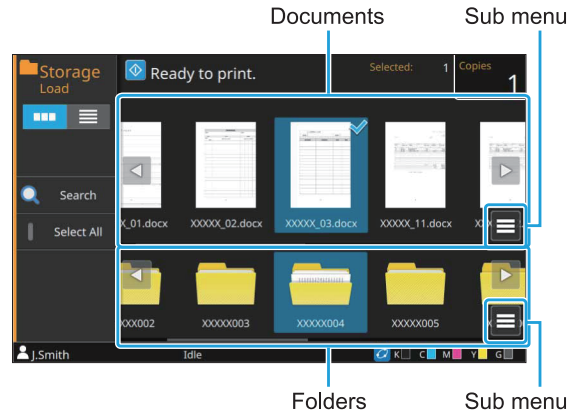

The list of folders shows the personal folder and the shared folders for which use is allowed by the administrator.

The following settings can be configured from the sub menu:

- Change Color
- Rename

The list of documents shows the documents that are saved in the selected folder.

The following settings can be configured from the sub menu:

- Details
- Change Setting
- Rename
- Delete
- Copy to USB Drive
- Copy to Folder

3 Enter the number of copies using the numeric keys.

4 Press the [Start] key.



• Documents are saved in a folder in the form of data that includes setting details. When printing these documents, use the same paper type as that used when saving the data in the folder.

List of Settings in [Storage] - [Save]

The following is a list of settings available in the [Storage] - [Save] mode.

Setting item	Use this item to:	Reference Page
View Selection	Select whether to view items as thumbnails or as a list.	p.140
Select All	Select all of the documents that are displayed.	p.140
Save Document	Displays the settings screen for saving the data of an original onto the storage.	p.140
Add Folder	Add a new folder.	p.141

Select the folder on the [Storage] - [Save] screen, and touch [Save Document] to display the screen listing the setting items.

The settings that can be configured on this screen are listed below.

Setting item	Use this item to:	Reference Page
Document Name	View the document name when saving the data in a folder.	p.90
Color Mode	Select color or monochrome printing.	p.61
Reproduction Size	Reduce or enlarge the copied image.	p.61
Paper Selection	Change the paper tray, paper type, and feed control settings according to the copying paper.	p.61
Scanning Size	Specify the scanning size for originals.	p.63
Original Orientation	Specify the orientation of the original.	p.64
Duplex/Simplex	Specify the sides of the original to be scanned and the sides of the paper to be printed on.	p.64
Sort	Specify the printing method for making multiple copies of the original.	p.64
Scanning Level	Adjust the scanning level.	p.65
Print Density	Specify the print density.	p.65
ADF Scan & Pause	Scan the original as one job even when having to load the original in multiple sets due to the large number of pages in the original.	p.65
Mixed Size Original	Scan the original containing pages of the different original sizes.	p.65
Book Shadow Erasure	Remove shadows that appear in the center of images when an open book is scanned.	p.66
Page Split	Scan double-spread pages and split them into two parts (right and left).	p.67
Combine	Impose continuous pages onto one sheet.	p.68
Image Repeat	Impose multiple copies of the same original onto one sheet.	p.68
Booklet	Specify the imposition setting when creating a booklet. You can also bi-fold the pages and bind them in the center when the optional multifunction finisher is connected.	p.68
PIN Code	Configure whether to set a PIN code for the job. If a PIN code is configured, you will need to enter this PIN code when printing or deleting a document.	p.93
Stamp	Stamp the page number, date, or text in the header or footer.	p.69

Setting item	Use this item to:	Reference Page
Page Border	This option adds a border line in the margins of the paper.	p.71
Image Quality	Specify the resolution for scanning originals.	p.71
Original Type	Select the original type so that the appropriate image processing is performed before printing the scanned data.	p.71
Gamma Correction	Adjust the color balance (CMYK) of the scanned data.	p.72
Image Control	Specify the image processing appropriate for the original.	p.72
Base Color Level	Make the background color (base color) lighter so that the text is easier to read.	p.72
Image Position	Adjust the print position.	p.73
Program	Specify the number of copies by group (such as corporate division or class). You can quickly print exactly the number of copies of the number of sets you need.	p.74
Add Cover	Add front and back covers to the printout.	p.77
Separation	Insert slip sheets. When the optional face down finisher, high capacity stacker, or multifunction finisher is connected, the offset output setting is also available.	p.77
Binding Margin	Print with a binding margin for the pages. Specify the binding edge and the value for the binding margin.	p.78
Staple / Punch	Specify the stapling position.	
	When using the optional face down finisher	p.184
	When using the optional multifunction finisher	p.214
	Specify the punch position. (When using the optional multifunction finisher with the punch unit)	p.214
Fold	Configure the paper folding settings. (When using the optional multifunction finisher with the folder unit)	p.215
Slow Printing	Decrease the printing speed. This also reduces the amount of noise produced by the machine when printing jobs.	p.79
Output Tray	Select the output tray for printouts.	
	When using the optional auto-control stacking tray / wide stacking tray	p.194
	When using the optional high capacity stacker	p.201
	When using the optional multifunction finisher	p.217
Face Up/Down	Specify whether to stack the pages face up or face down in the stacker.	
	When using the optional auto-control stacking tray / wide stacking tray	p.194
	When using the optional high capacity stacker	p.201
	When using the optional multifunction finisher	p.217
Output Tray Relay	Switch the output tray automatically when the tray that is being used becomes full.	
	When using the optional auto-control stacking tray	p.194
	When using the optional high capacity stacker	p.201
	When using the optional multifunction finisher	p.217
Paper Tray Relay	Feed paper automatically from a different tray with the same paper size and paper type when the selected tray runs out of paper.	p.79
Auto Image Rotation	Rotate the image 90 degrees automatically when the orientation of the original and paper do not match.	p.79

Setting item	Use this item to:	Reference Page
Favorites	Call frequently used settings.	p.140
Check Setting	Check the current settings.	p.140
Preview before saving	Scan and display the original before saving.	p.140
Custom Menu	Register favorites and default settings, and edit the button order.	p.141

List of Settings in [Storage] - [Load]

The following is a list of settings available in the [Storage] - [Load] mode.

Setting item	Use this item to:	Reference Page
View Selection	Select whether to view items as thumbnails or as a list.	p.141
Search	Search for documents within the folder.	p.142
Select All	Select all of the documents that are displayed.	p.142

When you select a document in the [Storage] - [Load] screen and touch [Change Setting] in the sub menu, the setting screen is displayed.

The settings that can be configured on this screen are listed below.

Setting item	Use this item to:	Reference Page
Paper Selection	Change the paper tray, paper type, and feed control settings according to the copying paper.	p.61
Print Density	Specify the print density.	p.65
Image Position	Adjust the print position.	p.73
Slow Printing	Decrease the printing speed. This also reduces the amount of noise produced by the machine when printing jobs.	p.79
Check Setting	Use this option to check the current settings.	p.142

Storage Mode Function Buttons

Function Buttons in [Storage] - [Save]

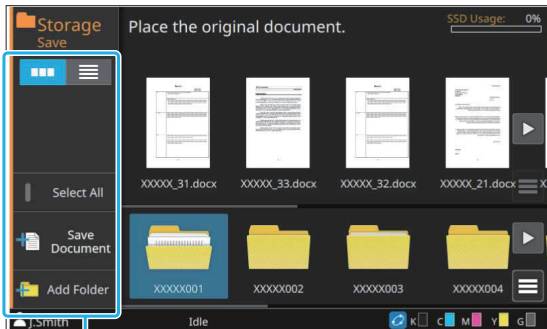

Function buttons

View Selection

You can select whether to view the folders and documents as thumbnails or as a list.

[]: View as thumbnails

[]: View as list

Select All

Touch this to select all documents that are saved in the selected folder. Touch this again to cancel the selection.

Save Document

Change the settings when saving the document in a folder.

For more information on the settings buttons, see "List of Settings in [Storage] - [Save]" (p.137).

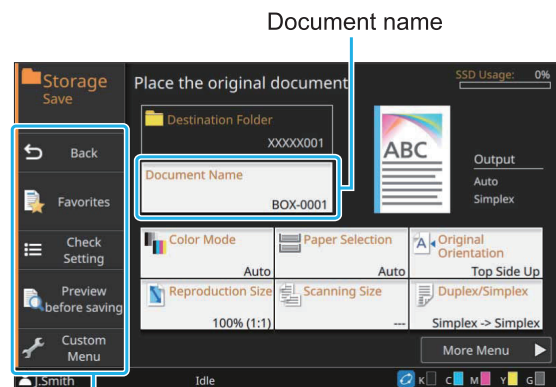

Function buttons

■ Back

Touch this button to display the folder/document list screen.

■ Favorites

Brings up settings that have been registered in advance.

For more information, see "Favorites" (p.81) in "Copying".

■ Check Setting

Check the settings of the document to save.

For more information, see "Check Setting" (p.82) in "Copying".

■ Preview before saving

You can scan and display the original before saving.

1 Touch [Preview before saving].

The [Confirm] screen is displayed.

2 Touch [Continue] to start the scan.

The preview screen is displayed. Check the scan results.

3 Press the [Start] key.

The data is saved.



- When the scanned data contains multiple pages, flick the screen to move between different pages. You can also move between pages by touching [◀] or [▶].

■ Custom Menu

You can register favorites and default settings, and edit the button order.

For more information, see "Custom Menu" (p.82) in "Copying".

■ Document Name

Touch [Document Name] to set the document name that will be used when the document is saved in a folder.

[Document Name]

Displays the document name with the details specified with [Input Method]. The file extension will not be displayed.

[Input Method]

[Auto]: Sets the document name automatically. In the default setting, documents are named as "BOX-" with a serial number (0001 to 9999) that follows.

[Direct Input]: Used to enter a document name of your choice.

1 Touch [Document Name].

The [Document Name Setting] screen is displayed.

2 Select an option for [Input Method].

When [Direct Input] is selected, enter a document name and touch [OK].

3 Touch [OK].



- For more information on text input, see "Entering Text" (p.43).
- For [Direct Input], you can use uppercase and lowercase letters.

Add Folder

Newly add a folder.

1 Touch [Add Folder].

The [Folder Name] input screen is displayed.

2 Enter a folder name and touch [OK].



- For more information on text input, see "Entering Text" (p.43) under "Touch Panel".
- You can use alphanumeric characters (uppercase/lowercase).
- If the entered folder name is already in use, a dialog will appear and it will not be possible to register the folder.

Function Buttons in [Storage] - [Load]

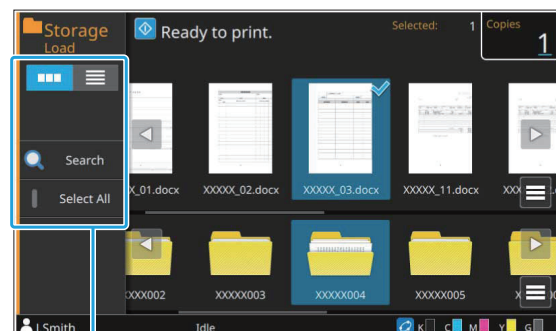

Function buttons

View Selection

You can select whether to view the documents as thumbnails or as a list.

[☰]: View as thumbnails

[☰]: View as list

Search

Search for documents within the folder.

1 Touch [Search].

The [Search] screen is displayed.

2 Enter the string of letters to search for and touch [OK].



- For more information on text input, see "Entering Text" (p.43).
- When a folder is selected in the list of folders/documents, the search will be performed within the selected folder.
- When a folder is not selected in the list of folders/documents, the search will be performed for all folders that the user who is logged in has access to.
- The following documents will not be subject to the search:
 - Documents with the [Hide Job Name] check box selected on the printer driver (p.125 "PIN Code")

Select All

Touch this to select all documents that are saved in the selected folder. Touch this again to cancel the selection.

Change Setting

When you select a document and touch [Change Setting] in the sub menu, the settings for printing the document can be changed.

For more information on the settings buttons, see "List of Settings in [Storage] - [Load]" (p.139).

■ Back

Touch this button to display the folder/document list screen.

■ Check Setting

Use this option to check the current settings of the change setting screen.

The following setting can be configured from the sub menu:

- Setting Confirmation Print

Copying to a USB Flash Drive or Another Folder

Documents saved in a folder can be copied to a USB flash drive or another folder.

Select a document and perform the operation through the sub-menu.

■ Copy to USB Drive

Documents saved in a folder can be copied to a USB flash drive.

1 Insert a USB flash drive into the USB slot.

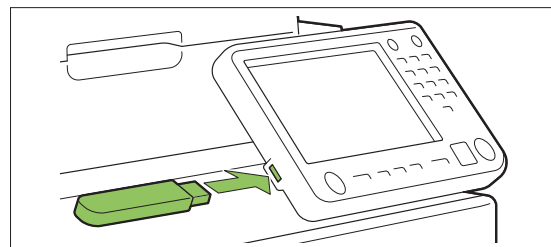

2 Display the sub-menu and touch [Copy to USB Drive].

3 Select the folder you wish to save the document in and touch [OK].

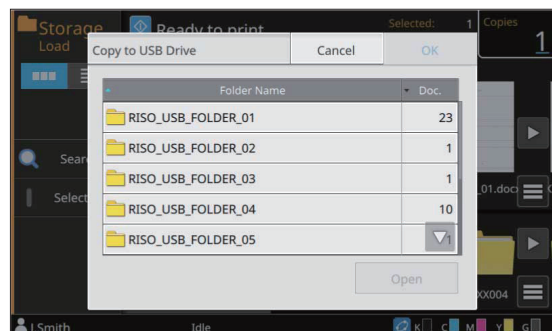



- By touching [OK] in a state where there are no folders on the USB flash drive, a folder will be automatically created and the document will be copied.
- Select a folder and touch [Open] to confirm a list of the documents inside the folder.

■ Copy to Folder

Documents saved in a folder can be copied to another folder.

- 1 Display the sub-menu and touch [Copy to Folder].
- 2 Select the folder you wish to save the document in and touch [OK].

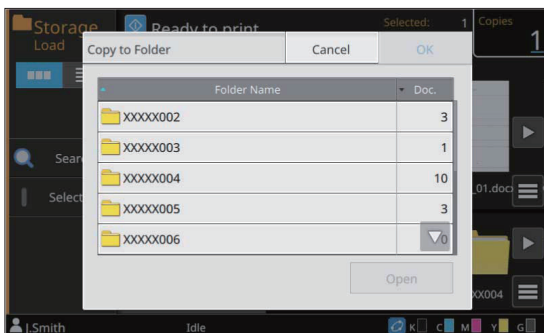

- Only the folders which can be used by the logged in user are displayed in the [Copy to Folder] screen.
- Select a folder and touch [Open] to confirm a list of the documents inside the folder.

You can save the scanned data to a USB flash drive connected to this machine.
You can also print documents that is saved on a USB flash drive from the printer driver.

Overview of USB Operations (Save) p.146

1. Insert a USB flash drive into the USB slot.
2. Load the original.
3. Select [USB] - [Save] on the [Home1] screen.
4. Select a folder to save the data to.
5. Touch [Save Document] to change the settings.
6. Press the [Start] key.

Overview of USB Operations (Load) p.147

1. Insert a USB flash drive into the USB slot.
2. Select [USB] - [Load] on the [Home1] screen.
3. Select a folder.
4. Select a document.
5. Enter the number of copies using the numeric keys.
6. Press the [Start] key.

USB Mode Function Buttons p.151

This section explains the functions available in USB mode.



5

USB

USB

Overview of USB Operations

This section explains the basic operations of the USB mode.

Saving the Scanned Data to a USB Flash Drive

Save the data scanned using this machine on a USB flash drive.

- 1) **Insert a USB flash drive into the USB slot.**

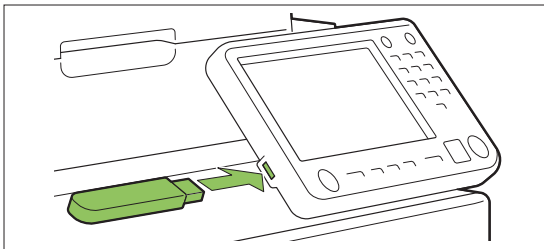

- 2) **Load the original.**

For more information on the types of originals that can be used, see "Originals" (p.22).

■ In the ADF

- 1) **Load the original in the ADF.**

Align the originals and place them face up.

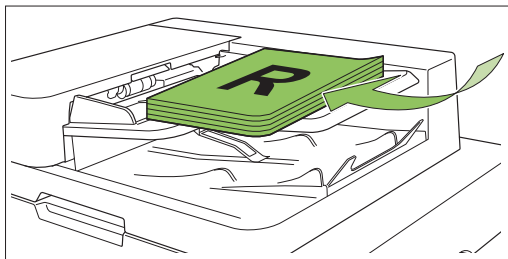

- 2) **Slide the original guides to match the width of the originals.**

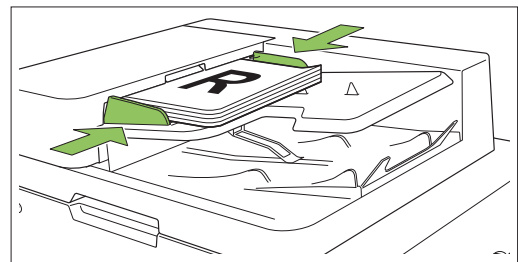

■ On the Platen Glass

- 1) **Open the original cover.**
- 2) **Load the originals.**

Load the original face down on the glass. Align the corner of the original with the upper-left corner of the glass.

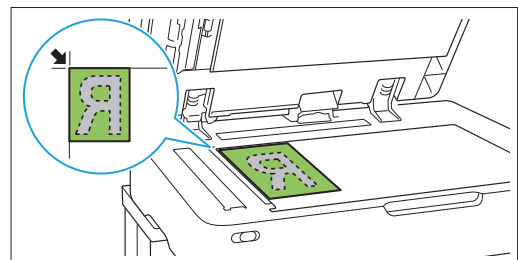

- 3) **Close the original cover.**



• Open and close the original cover gently.

3 Select [USB] - [Save] on the [Home1] screen.



4 Select a folder to save the data to.

5 Touch [Save Document].

Specify the detailed settings for saving the document.
For more information on the functions that can be configured, see "List of Settings in [USB] - [Save]" (p.149).

6 Press the [Start] key.

Printing a Document Saved on a USB Flash Drive

You can print documents that are saved on a USB flash drive.
For information on how to save documents on a USB flash drive, see "Output and Destination" (p.111) in "Printing".



- Files which can be printed are those in the PRN format only.
- PRN files are output by the printer driver in a format that was developed exclusively for RISO KAGAKU CORPORATION. PRN files cannot be opened using printers or applications by other manufacturers.
- If you are using the optional PS kit, you can also use PDF files. For more information, see "Printable Files in the USB Flash Drive" (p.232) in "Optional Equipment".

1 Insert a USB flash drive into the USB slot.

2 Select [USB] - [Load] on the [Home1] screen.

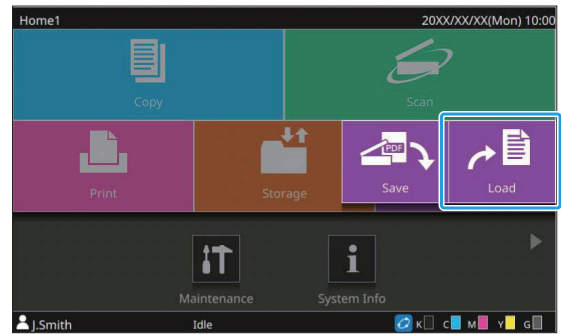

3 Select the folder you wish to use and touch [Open].

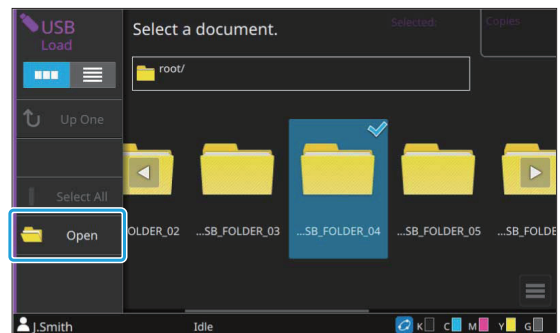

5

4 Select the document you wish to print.

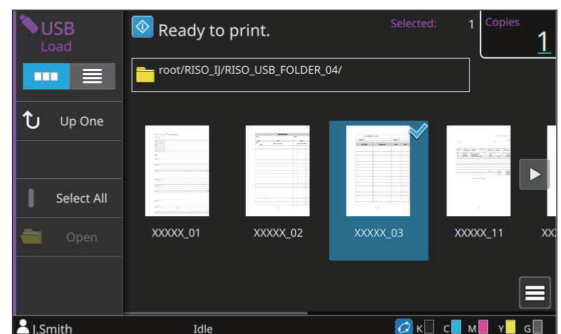

- If you want to change the print settings, touch [Change Setting] in the sub menu for files in the PRN format, or touch [Print Setting] for PDF files. For more information on the functions that can be configured, see the following:
 - For files in the PRN format (p.150 "List of Settings in [USB] - [Load]")
 - For files in the PDF format (p.234 "List of Settings in [USB] - [Load]")

5 Enter the number of copies using the numeric keys.

6 Press the [Start] key.

List of Settings in [USB] - [Save]

Select the folder on the [USB] - [Save] screen, and touch [Save Document] to display the screen listing the setting items. The settings that can be configured on this screen are listed below.

Setting item	Use this item to:	Reference Page
Document Name	View and specify the document name when saving the data on a USB flash drive.	p.90
Color Mode	Specify the color mode of the data to be scanned.	p.90
Scanning Size	Specify the scanning size for originals to be scanned.	p.91
File Format	Specify the file format for saving the scanned data.	p.91
Duplex/Simplex	Specify the sides of the original to be scanned.	p.91
Scanning Level	Adjust the scanning level.	p.65
Original Orientation	Specify the orientation of the original.	p.64
Resolution	Specify the resolution for scanning originals.	p.92
Mixed Size Original	Scan the original containing pages of the different original sizes.	p.65
Page Size	Specify the size for saving the scanned data.	p.92
Book Shadow Erasure	Remove shadows that appear in the center of images when an open book is scanned.	p.66
Page Split	Scan double-spread pages and split them into two parts (right and left).	p.67
Original Type	Select the original type to perform the appropriate image processing and save the scanned data.	p.93
Gamma Correction	Adjust the color balance (CMYK) of the scanned data.	p.93
Image Control	Specify the image processing appropriate for the original.	p.72
Base Color Level	Make the background color (base color) lighter so that the text is easier to read.	p.72
Reproduction Size	Reduce or enlarge the scanned data.	p.94
Favorites	Call frequently used settings.	p.151
Check Setting	Check the current settings.	p.151
Preview before saving	Scan and display the original before saving.	p.151
Custom Menu	Register favorites and default settings, and edit the button order.	p.151

List of Settings in [USB] - [Load]

Select the folder on the [USB] - [Load] screen, and touch [Open] to display a list of the documents inside the folder. When you select a document and touch [Change Setting] in the sub menu, the setting screen is displayed.

The settings that can be configured on this screen are listed below.

Setting item	Use this item to:	Reference Page
Paper Selection	Change the paper tray, paper type, and feed control settings according to the copying paper.	p.61
Print Density	Specify the print density.	p.65
Image Position	Adjust the print position.	p.73
Slow Printing	Decrease the printing speed. This also reduces the amount of noise produced by the machine when printing jobs.	p.79
Check Setting	Check the current settings.	p.152



- If the optional PS kit is installed, PDF files saved on a USB flash drive can also be used. In this case, you can change the settings for printing PDF files. For more information, see "Printable Files in the USB Flash Drive" (p.232) in "Optional Equipment".

USB Mode Function Buttons

Function Buttons in [USB] - [Save]

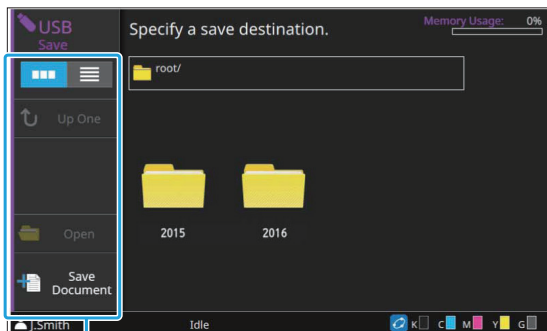

Function buttons

View Selection

You can select whether to view the documents as thumbnails or as a list.

[]: View as thumbnails

[]: View as list

Up One

Displays one higher tier.

Open

Opens the selected folder.

Save Document

Change the settings when saving the document on a USB flash drive.

For more information on the settings that can be configured, see "List of Settings in [USB] - [Save]" (p.149).

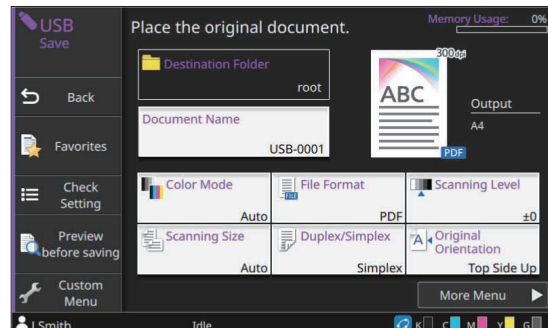

■ Back

Touch this button to display the document list screen.

■ Favorites

Brings up settings that have been registered in advance.

For more information, see "Favorites" (p.81) in "Copying".

■ Check Setting

Use this option to check the current settings. The following setting can be configured from the sub menu:

- Add to Favorites
- Save as Default
- Setting Confirmation Print

■ Preview before saving

You can scan and display the original before saving.

For more information, see "Preview before saving" (p.140) in "Storage".

■ Custom Menu

You can register favorites and default settings, and edit the button order.

For more information, see "Custom Menu" (p.82) in "Copying".

Document Name

View the document name when saving the data on a USB flash drive. Touch [Document Name] to set the document name. For more information, see "Document Name" (p.90) in "Scanning".



- If you select [Auto] for the [Input Method], a document is named with a serial number (0001 to 9999) given following "USB-" as the default setting.

Function Buttons in [USB] - [Load]

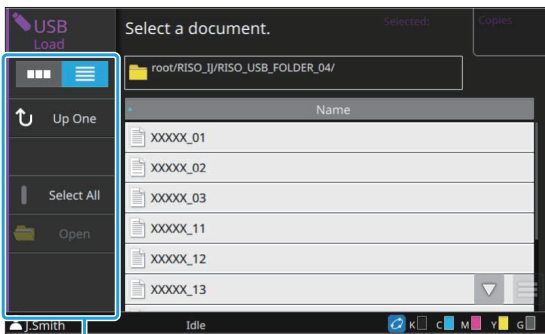

Function buttons

View Selection

You can select whether to view the documents as thumbnails or as a list.

[]: View as thumbnails

[]: View as list



- Touch categories such as [Name] or [Doc.] to switch the sorting order between ascending and descending for display in the list.

Up One

Displays one higher tier.

Select All

Touch this to select all documents that are saved in the selected folder. Touch this again to cancel the selection.

Open

Opens the selected folder.

Check Setting Values of Document

Select a document and touch [Details] in the sub-menu to check the setting values of the selected document.

Change Setting

When you select a document and touch [Change Setting] in the sub menu, the settings for printing the document can be changed.

For more information on the settings that can be configured, see "List of Settings in [USB] - [Load]" (p.150).

■ Back

Touch this button to display the document list screen.

■ Check Setting

Use this option to check the current settings.

The following settings can be configured from the sub menu:

- Setting Confirmation Print

Copy to Folder

Documents saved on a USB flash drive can be copied to a folder on the machine.

- 1 Select a document, display the sub-menu, and touch [Copy to Folder].**
- 2 Select the folder you wish to save the document in and touch [OK].**



- A document cannot be copied from one folder on the USB flash drive to another folder on the USB flash drive.
- Only the files which can be used by the logged in user are displayed in the [Copy to Folder] screen.
- Select a folder and touch [Open] to confirm a list of the documents inside the folder.

RISO Console

The RISO Console is software that uses a Web browser to remotely control this machine. With a computer connected to the printer via a network, you can check the printer status, change the settings of a job, and perform other operations.

Overview of the RISO Console

p.156

Starting the RISO Console



Common Button Operations

[System Info] Menu

p.159

This section explains the functions available on the [Consumables], [Machine Info], [User Info], and [License Info] screens.

[Scan] Menu

p.162

This section explains the functions available on the [Scan] menu.

[Print] Menu

p.163

This section explains the functions available on the [Print] menu.

[Storage] Menu

p.164

This section explains the functions available on the [Storage] menu.

[Job Status] Menu

p.165

This section explains the functions available on the [Job Status] menu.

[Maintenance] Menu

p.166

This section explains the functions available on the [Maintenance] menu.



Overview of the RISO Console

This section explains the functions of the RISO Console.

Top Screen



- Make sure the machine is connected to the network.

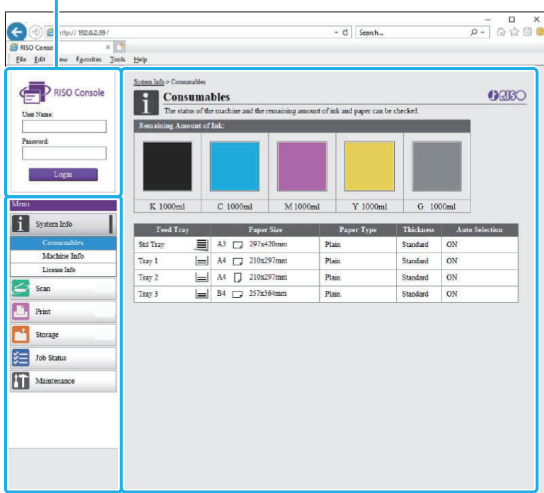

Status pane



Side menu

Content pane



- When an item on the side menu has the  icon, this indicates that you must log in before you can access that item. When an item is displayed with the  icon after logging in, the access to the mode is restricted.
- The  mark is displayed on the left side of the screen while information on the machine is being collected.
- The supported Web browsers are as follows.
 - Windows® Internet Explorer Ver11.0
 - Microsoft® Edge
 - Safari® (for Mac OS)
- The RISO Console screen is not displayed when using certain power saving settings. Contact your administrator for details.

- The side menu that is displayed will differ depending on the settings configured by the administrator.

Side Menu

The information and the functions that are available on the side menu of the RISO Console are as listed below.

System Info		
Consumables	View the status of the consumables, such as the remaining amount of ink or paper.	p.159
Machine Info	<ul style="list-style-type: none"> • View the status of the printer. • View the printer model, serial number, MAC address, and other system information. • Confirm the detailed count. 	p.159
User Info	View information about the user currently logged in.	p.161
License Info	View the license information of the system used in this product.	p.161
Scan		
	Search, view, delete, or download scan jobs that are saved on the internal SSD of the machine.	p.162
Print		
	View or delete jobs.	p.163
Storage		
Load	<ul style="list-style-type: none"> • Search documents in a folder. • Edit folders (add, change color, etc.) 	p.164

Form Data	Search, view, print, or delete jobs that are output via [Form] from the printer driver. (When the optional PS kit is installed)	p.232
Job Status		
Active / Idle	Search, view, or delete jobs that are being processed or waiting.	p.165
Finished	Search, view, delete, or re-print jobs that have finished.	p.165
Maintenance		
Head Cleaning	Clean the print head.	p.166
Glue Temperature	Preheat the glue unit. (when using the optional Perfect Binder)	p.166

Starting the RISO Console

Connect the computer to the network before starting the RISO Console. Connection to the Internet is not required.

- 1 Start your Web browser.**
- 2 Enter the IP address of the printer in the address box of your Web browser.**

To view the IP Address of the printer, select [Machine Info] in [System Info] on the operation panel of this machine.

<Example of how to enter the IP address "192.0.2.99">

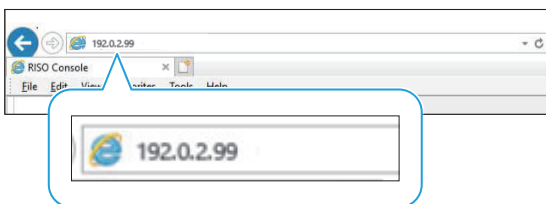

- 3 Press the [Enter] key.**
The [System Info] screen of the RISO Console is displayed.



- You can create a shortcut on the desktop to quickly bring up the RISO Console.
- If the RISO Console is not operated for 5 minutes or more, it will disconnect the connection with the printer. To reconnect with the printer, refresh the display of the Web browser.

Logging In

When an item on the side menu has the  icon, this indicates that you must log in before you can access that item.

- 1 Enter your user name and password in the status pane.**

Your password should consist of 0 to 16 characters (numbers and/or lowercase letters). The entered characters are displayed with asterisks (*).

- 2 Click [Login].**

The [System Info] - [Consumables] screen is displayed.

■ Logging Out

Click [Logout] in the status pane.



- If you forget your password, contact your administrator.
- You can change the user password on the [System Info] - [User Info] screen. (p.161 "[User Info] Screen")

Common Button Operations

The [Scan] menu screen, [Print] menu screen, [Storage] menu screen, and [Job Status] screen have common buttons that serve the same purposes.

The [Scan] menu screen is used here as an example to explain the respective functions.

Thumbnail Display

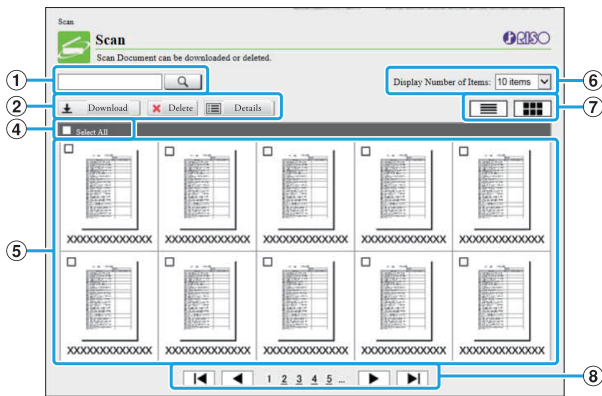

List Display

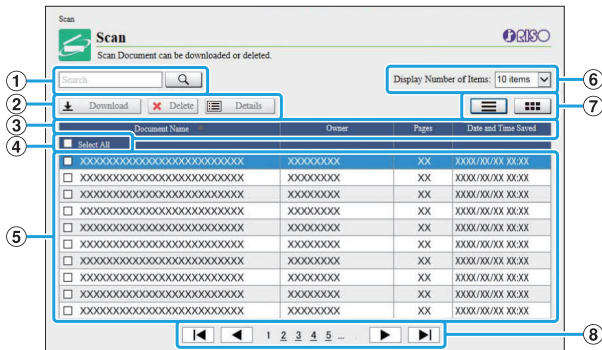

① Search

Use this function to search jobs.
You can use search strings up to 256 characters long.

② Menu

Select a job and click a menu option.
The menu options displayed depend on the screen.

③ Title bar (list display only)

You can sort jobs by clicking an item in the title bar ([Document Name], [Owner], [Pages], or [Date and Time Saved]).

④ Select All

Select this option if you want to select all jobs.

⑤ Jobs

To select a job, click the job name to add a check mark.

⑥ Number of jobs displayed on a page

Select the number of jobs to be displayed on a page.

⑦ Display switching ([Scan] screen and [Print] screen only)

Click or to switch between list and thumbnail display.

⑧ Page switching

or : Moves to the first or last page.
 or : Moves to the previous or next page.
1 2...: Moves to the specified page that you click.



- When you select a job with a PIN code assigned, the PIN code input screen is displayed if clicking [Download], [Delete], or [Details]. Enter the PIN code and click [OK].
- You can select more than one job.
- If the job name, owner, or folder name exceeds the maximum displayable number of characters, they are displayed with the first part of the name omitted and replaced with "...".

[System Info] Menu

[Consumables] Screen

This screen displays information on the ink and paper.

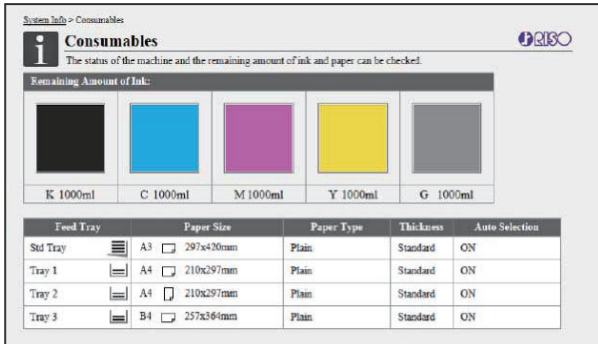

Remaining Amount of Ink

The remaining amount of ink is displayed in 10 levels for each ink cartridge.

The indicator starts flashing when the time to replace an ink cartridge comes close. Prepare a new ink cartridge for the color that flashes.



- The remaining amount of ink is indicated based on the bottle capacity.
- If you are not using RISO ink, the remaining amount of ink is not displayed.

Paper Status

The estimated remaining amount of paper, paper size, paper type, thickness, and whether [Auto Selection] is [ON] are all displayed for each tray. The remaining amount of ink is displayed as follows:

- Standard Tray: 51 - 100%, 31 - 50%, 11 - 30%, 1 - 10%, 0%
- Feed Trays 1 through 3: 51 - 100%, 1 - 50%, 0%
- Optional Additional Tray: 51 - 100%, 31 - 50%, 10 - 30%, 1 - 9%, 0%

When ↓ or ↓ is displayed, please be sure to reload paper.

For the paper settings, see "Changing the Paper Tray Setting" (p.62) in "Copying".

[Machine Info] Screen

This screen displays the status of this machine, the connection status of optional equipment, the serial number, used space on the internal SSD and other system-related information.

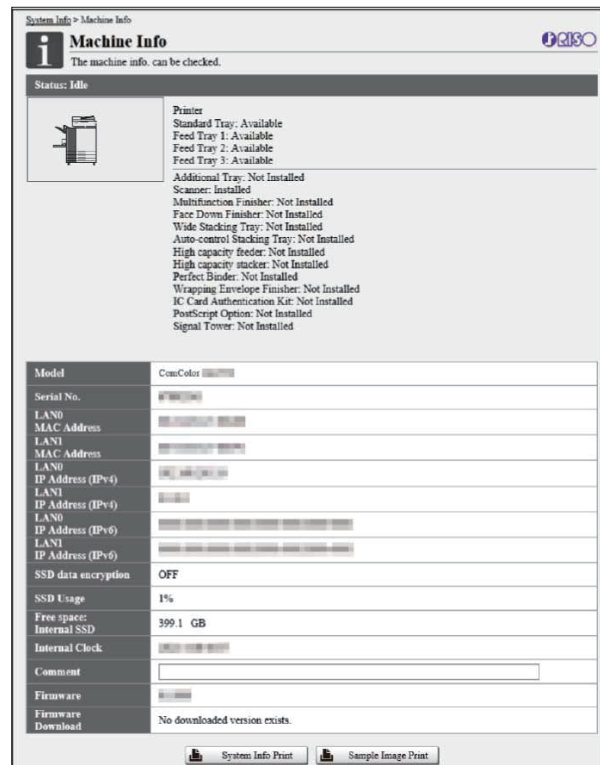

Machine Status

The status of this machine, availability of trays, and connection status of optional equipment are all displayed.

If an error occurs, the error message is displayed.

Machine Info

Model: Machine model.

Serial No.: Machine serial number.

MAC address (LAN0/LAN1): Machine MAC address.

IP address (IPv4/IPv6) (LAN0/LAN1): Machine IP address.

SSD data encryption: Displays the status (ON or OFF) of the data encryption setting of the internal SSD.

SSD Usage: Ratio of used internal SSD space.

Free space: Displays the available space of the internal SSD in [Internal SSD]. [External HDD] displays the available space on the external hard disk that is connected with the machine.
Comment: Comments entered by the administrator. Only a user with the administrator account can enter comments.
Firmware: Version of the firmware.
Firmware download: Displays the status of acquiring the firmware.



- The machine has two LAN ports including LAN0 and LAN1. Normally, use the LAN0 port. When connecting to the optional print controller, use the LAN1 port.
- [External HDD] is displayed when an external hard disk is connected with the machine.
- If the status of acquiring the firmware is updated in the [Machine Info] screen, the message for [Firmware download] will not be automatically updated as well. To confirm the latest status of the machine, refresh the display of the Web browser.

[System Info Print]

Click this button to print the system information.

[Sample Image Print]

Click this button to print a sample page so you can check the result of a printed image.

Checking the Detailed Count

The total count of prints and copies of this machine and the count for each paper size are displayed.

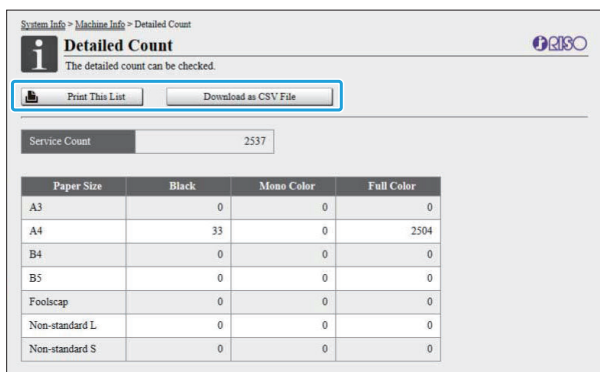

[Print This List]

Click this button to print the latest information.

[Download as CSV File]

Click this button to save the latest information to a computer as a CSV file.

[Service Count]

The total number of times of paper transport when printing and copying is displayed.

The number of times of paper transport is counted as 2 times per sheet when duplex printing is performed.

Detailed Count

The count for each paper size is displayed.



- When you click [Print This List] or [Download as CSV File], the latest information is obtained and may be different from the information displayed on the screen.

Checking the Charge Count

The charge count for each paper size division is displayed separately for monochrome and color.

[Print This List]

Click this to print the latest information.

[Download as CSV File]

Click this button to save the latest information to a computer as a CSV file.

[Meter Reading Report Setting]

The charge type is displayed.



- The [Meter Reading Report] screen is only displayed when using ComColor GL9730R/GL7430R.
- When you click [Print This List] or [Download as CSV File], the latest information is obtained and may be different from the information displayed on the screen.
- For more information on the charge counting, contact your dealer or authorized service representative.

[User Info] Screen

The information about the user currently logged in is displayed.

- If login is unnecessary, the [User Info] screen is not displayed.

	Print		Copy	
	Monochrome	Full Color	Monochrome	Full Color
Limit	10000	10000	10000	10000
Current	0	635	0	0
Remaining Count	10000	9365	10000	10000

[Change Password]

You can change the password.

User Info

This screen displays the user name and groups of the user logged in.

Limits

The printable and copyable limits established by the administrator and the current number of printouts and copies made by the user logged in are displayed.



- The information displayed is registered by the administrator. If the facts are different from the information displayed, contact your administrator.

Changing the Login Password

Users can change their own login passwords.

- 1 Click [Change Password].
- 2 Enter the new password in [New Password].
Your password should consist of 0 to 16 characters (numerals and/or lowercase letters). The entered characters are displayed with asterisks (*).
- 3 Enter the new password again for confirmation.

4 Click [OK].

The screen is displayed to indicate that the settings are sent.

5 Click [OK].

[License Info] Screen

The [License Info] screen displays information about the license of the open source software used in the machine.

[Scan] Menu

[Scan] Menu Screen

You can download the scanned data saved on the internal SSD of the machine to a computer.

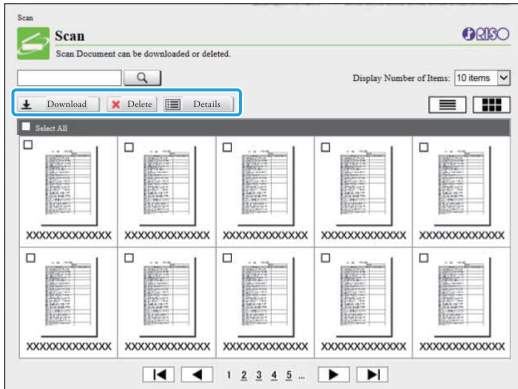

[Download]

Download the selected job.

[Delete]

Click this button to delete the selected jobs.

[Details]

You can view the settings, file capacity, and other information on the selected job.



- The storage period for scanned jobs is configured by the administrator with [Scan Document Save Setting]. When that period is reached, the job is deleted automatically.

Downloading Scanned Jobs to a Computer

1 Select the check box of the scanned job to download.

You can select more than one job.

2 Click [Download].

The screen indicating that a zip file is being created is displayed.

- For jobs with a PIN code, the PIN code input screen is displayed. Enter the PIN code and click [OK].

3 Click the link to the zip file.

The [Save As] dialog box is displayed.

4 Specify the destination folder and file name, and then click [Save].

The scanned data is saved to the computer.

[Print] Menu

[Print] Menu Screen

You can check the status of jobs that are sent from the printer driver and saved on the internal SSD of the machine.

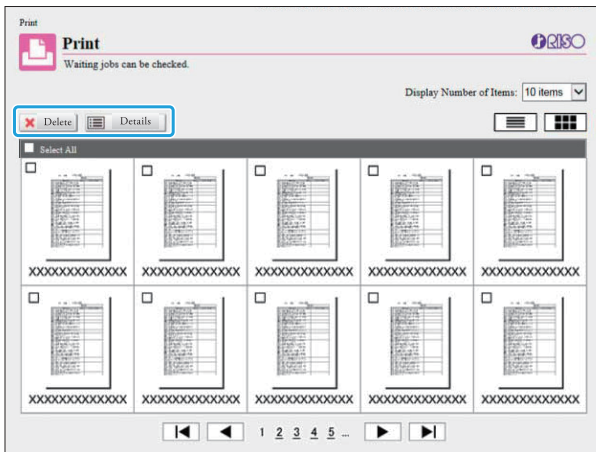

[Delete]

Click this button to delete the selected jobs.

[Details]

You can view the settings, file capacity, and other information on the selected job.



- In the following cases, all job names are displayed in the list:
 - When user login is not required
- In the following cases, the job name is displayed as "*****":
 - Jobs with the [Hide Job Name] check box selected on the printer driver (p.125 "PIN Code")

[Storage] Menu

[Load] Screen

The shared folders and personal folders are displayed.

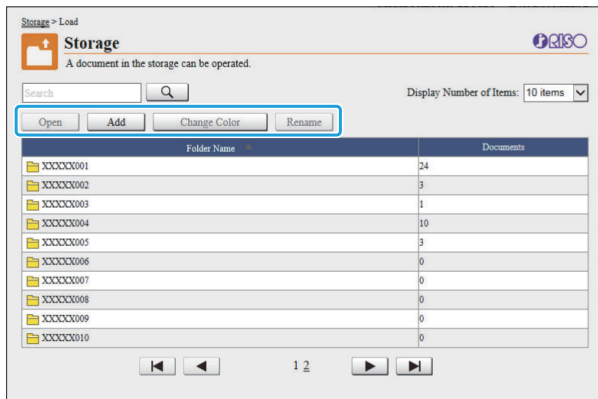

[Open]

Click this button to display a list of documents in the folder.

[Add]

Click this button to add a folder. You can enter 1 to 128 characters for the folder name.

[Change Color]

Click this button to change the color of the selected folder.

[Rename]

Click this button to change the name of a folder. You can enter 1 to 128 characters for the folder name.



- The functions may not be available, depending on how the administrator has configured the settings.

Managing Documents in a Folder

[Close]

Close the document list screen and display the [Load] screen.

[Print]

Print the selected documents.

[Delete]

Delete the selected documents.

[Copy to Folder]

Select the folder that you want to copy to, and click this button to copy the documents.

[Details]

Click this button to view the settings for the selected document. You can also change the settings.

[Download]

If the optional PS kit is installed, you can save the selected PostScript jobs to a computer.

1 Select a folder and click [Open].

The screen displays a list of documents in that folder.

2 Operate documents.

The following functions are available for selected documents:

- Print
- Delete
- Copy to Folder
- Details
- Download

[Job Status] Menu

[Active / Idle] Screen

The jobs that are being printed and the jobs that are waiting to be printed are displayed.

Job Name	Owner	Copies	Received	Status
XXXXXX_41.pdf	J.Smith	32	17:36	Printing
XXXXXX_52.pdf	J.Smith	56	17:36	Processing
XXXXXX_12.docx	J.Smith	1	17:36	Processing
XXXXXX_11.docx	J.Smith	1	17:36	Processing
XXXXXX_21.docx	J.Smith	1	17:36	Processing
XXXXXX_31.docx	J.Smith	1	17:36	Processing
XXXXXX_01.docx	J.Smith	2	17:36	Processing
XXXXXX_02.docx	J.Smith	1	17:36	Processing
XXXXXX_32.docx	J.Smith	1	17:36	Processing
XXXXXX_13.docx	J.Smith	1	17:36	Processing

The field for [Status] shows the status of each job ("Printing", "Suspended", etc.).

[Delete]

Click this button to delete the selected jobs.

[Details]

Click this button to view the settings for the selected job. The displayed contents differ depending on the job type.



- Jobs are displayed on the [Active / Idle] screen when [Login Setting] is set to [OFF].
- An icon indicating the job type is displayed on the left side of the job name. For more information, see "[Active / Idle] Screen" (p.52) in "About Jobs".

[Finished] Screen

The [Finished] screen displays finished print jobs, suspended print jobs, and print jobs with errors.

Job Name	Owner	Copies	Finished	Result
XXXXXX_33.docx	J.Smith	1	17:37	Completed
XXXXXX_32.docx	J.Smith	1	17:37	Completed
XXXXXX_13.docx	J.Smith	1	17:37	Completed
XXXXXX_03.docx	J.Smith	1	17:37	Completed
XXXXXX_01.docx	J.Smith	1	17:37	Completed
XXXXXX_02.docx	J.Smith	1	17:37	Completed
XXXXXX_11.docx	J.Smith	1	17:37	Completed
XXXXXX_21.docx	J.Smith	1	17:37	Completed
XXXXXX_31.docx	J.Smith	1	17:37	Completed
XXXXXX_52.pdf	J.Smith	1	17:37	Completed

The field for [Result] shows the result of each job ("Completed", "Error", etc.).

[Reprint]

Click this button to print the selected job again.

[Delete]

Click this button to delete the selected jobs.

[Details]

Click this button to view the settings for the selected job. The displayed contents differ depending on the job type.



- The finished jobs are only displayed when the [Finished Job Setting] on the administrator menu is set to [Save].
- The print function is not available in the following cases:
 - When a job that did not finish properly is selected
 - When a non-print job is selected
 - When printing of a finished job is not permitted
 - When a color job is selected although color printing is not permitted
- The storage period for jobs is configured by the administrator.
- An icon indicating the job type is displayed on the left side of the job name. For more information, see "[Finished] Screen" (p.53) in "About Jobs".

[Maintenance] Menu

[Maintenance] Menu Screen

On this screen, you can configure the user-configurable functions of the printer main unit (system).

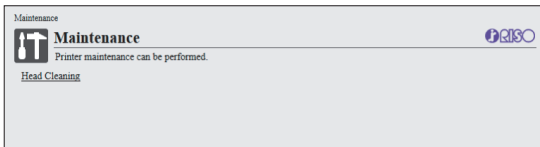

[Head Cleaning]

Click this item to clean the print head to prevent clogging. Clean the print head when you notice a change in image quality, such as blurring in part of a printout, white streaking, or faded colors. When the printer is being used, cleaning of the print head is performed after the printer has finished printing or copying.

[Glue Temperature]

Preheats the glue unit when using the optional Perfect Binder.

Head Cleaning

- 1 Click [Head Cleaning].
- 2 Click [OK].
The screen is displayed to indicate that the settings are sent.
- 3 Click [OK].

Glue Temperature

Preheats the glue unit when using the optional Perfect Binder.
For more information, see the user's guide for the Perfect Binder.

Using the Barcode Area Definition Software

The Barcode Area Definition Software is designed exclusively for use with ComColor GL series products.

The software is used to specify information about the barcode print position, so that highly readable barcodes can be created in documents.

This chapter describes how to install and operate the Barcode Area Definition Software, and how to register a file that defines the barcode position to the printer.

Overview of the Barcode Area Definition Software

p.168

Installing the Barcode Area Definition Software

Creating and Registering a Barcode Area Definition

File

p.171

1. Create a PRN file.



2. Read the PRN file.



3. Specify the barcode area.



4. Save the barcode area definition file.



5. Register the barcode area definition file.



Overview of the Barcode Area Definition Software

Installing the Barcode Area Definition Software

You need to install the Barcode Area Definition Software before using it for the first time.

Operating Environment

The system requirements for activating the Barcode Area Definition Software are described in the table below.

Memory	1 GB or more
CPU	Intel® or fully compatible CPU
Hard disk	2 GB or more free space (Sufficient to operate the OS)
Display	1024 × 768 or greater resolution

Installing



- Log in as a user with administrator privilege.
- Close all active applications.

- 1 Load the included RISO Printer Driver DVD-ROM in the computer's DVD-ROM drive.
- 2 Open the [Utility] - [BarcodeAreaDefinitionSoftware] folder on the DVD-ROM, and double-click the "setup.exe" file.
- 3 Select the desired language in the pull-down menu and click [OK].

- 4 Click [Next].

- 5 Select [I accept the terms in the license agreement] and click [Next].

- 6 Follow the on-screen instructions to configure the settings.



- When installation is complete, a "Readme" screen is displayed. The "Readme" screen includes precautions for using the machine. Be sure to read this information.

- 7 Remove the DVD-ROM from the computer.



- Keep the DVD-ROM in a safe place for future reference.

■ Uninstalling

- 1 Click [Start] - [Settings] - [Apps] - [Barcode Area Definition Software] - [Uninstall].
- 2 Follow the on-screen instructions to uninstall the Barcode Area Definition Software.
- 3 After the Barcode Area Definition Software has been uninstalled, restart the computer.

Starting the Barcode Area Definition Software

1 Click [Start] - [RISO] - [Barcode Area Definition Software].

For Windows 8.1, open the "Apps" screen and select [RISO] - [Barcode Area Definition Software].

Main Screen

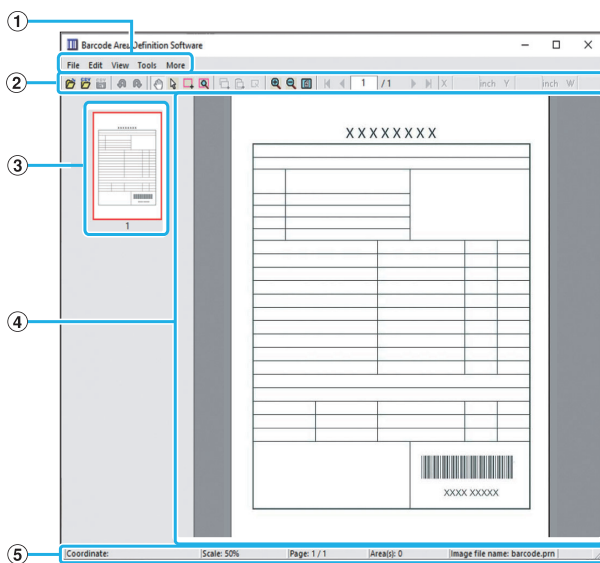







- ① **Menu bar**
The menu bar consists of the [File], [Edit], [View], [Tools] and [More] menus. Each menu includes an edit function and setting items.
- ② **Tool bar**
Various tools are displayed.
- ③ **Thumbnail**
A thumbnail of the print image is displayed.
- ④ **Image/barcode area display**
The print image is displayed.
- ⑤ **Status bar**
The position (coordinates), magnification, page number and other details are displayed.

Operations

To edit the barcode area, select the print image area and use the functions in the tool bar or menu bar. When the same icon appears in both the tool bar and the menu bar, you can click either one to perform the same operation.

Menu bar	Function
File	
Open Image File	Opens a selected print file, and display its image.
Open CSV File	Opens a selected CSV file.
Recreate CSV File	Deletes the barcode area that is displayed.
Save	Saves the CSV file that you are currently using.
Save As	Saves the currently open file under a new file name.
Page Settings	You can specify the page size of a barcode creation area.
Edit	
Undo	Cancels the edit and returns the setting to its original state.
Redo	Reapplies the previously canceled edit. The 10 most recent edits can be redone.
Copy	Copies the selected barcode area.
Paste	Pastes the copied barcode area to another area.
Delete	Deletes the selected barcode area.
Repetition	You can specify the same barcode area repeatedly. You can specify a cycle of 1 to 999 pages.
View	
Move	Moves to the first, previous, next, or last page.
Go to	Moves to the specified page. Input the desired page number in the text box, and press the [Enter] key. (This is only displayed in the tool bar.)

Menu bar	Function
Area minor adjustment tool (X/Y/W/H)	Displays the coordinates (X/Y), width (W), and height (H) of the barcode area in the display unit format (mm/inch). Enter a value in the box to change the barcode area to a specified position or size. (This is only displayed in the tool bar.)
Rotate	Rotates the on-screen print image 90 degrees to the left or right.
Display Units	You can specify mm or inch as the unit to use on the barcode area definition page.
Zoom 	You can specify the magnification ratio for the print image, fit the full image on the page, fit the image to the width of the page, enlarge it, or reduce it.
Thumbnail	Displays or hides the thumbnail.
Status Bar	Displays or hides the status bar.
Tool Bar	Displays or hides the tool bar.
Tools	
 Hand Tool	You can drag a print image to change its display position.
 Selection Tool	You can select a barcode area. Press and hold the Ctrl key to select multiple barcode areas. The selected area is indicated by  .
 Creation Tool	You can specify the barcode area, where the print density is adjusted to make the area suitable for reading. The enclosed area is indicated by  .
 Auto Area Detection	Automatically detects the barcode area on all pages or specified pages.
More	
Version	Displays the version information.



Creating and Registering a Barcode Area Definition File

Output the original data from the printer driver in PRN file format. Open the PRN file using the Barcode Area Definition Software, specify the barcode area, and create a CSV file. The administrator uses the RISO Console to register the barcode area definition file to the printer.

Procedure

1 Create a PRN file.

Output the original with printed barcode in PRN file format.

1) Click **[Properties]** (or **[Preferences]**) in the printing dialog box of the application on the computer.

2) Click the **[Basic]** tab.

3) Select **[Save as a File]** in the **[Output]** pull-down menu.



- If the optional PS kit is installed, select **[Storage]**.
- PRN files are output by the printer driver in a format that was developed exclusively for RISO KAGAKU CORPORATION. PRN files cannot be opened using printers or applications by other manufacturers.

4) Click **[Details]**, and specify a destination.

5) Click **[OK]**.

6) Click **[Print]**.

A PRN file is created in the specified destination.

7) If the optional PS kit is installed, use the RISO Console to download documents saved in the folder.

Start the RISO Console, select the saved documents on the **[Load]** screen in the **[Storage]** menu, and then click **[Download]**.



- Configure the same settings for the printer driver as when you actually print, except for the **[Output]** setting. If the PRN file format and the actual print setting (original size, print direction, paper size, imposition, etc.) are different, the barcode area definition may not be correctly applied. If you change any settings related to the layout, the coordinates of the area also change.

2 Read the PRN file.

Open the PRN file (print image) using the Barcode Area Definition Software.

1) Click **[Start]** - **[RISO]** - **[Barcode Area Definition Software]**.

For Windows 8.1, open the "Apps" screen and select **[RISO]** - **[Barcode Area Definition Software]**.

2) Click **[File]** - **[Open Image File]**, and select the PRN file.

3) Specify the number of pages to read.

Select the **[Detect Barcode Areas Automatically.]** check box to automatically detect the barcode area on all pages.

4) Click **[OK]**.

The print image of the original appears in the image/barcode area.



- If you use mixed-size data, the original data may be oriented differently from the print image. Select **[View]** in the menu bar, rotate the print image in the same direction as the original data, and specify the barcode area.

- The maximum barcode size that can be read by [Detect Barcode Areas Automatically.] is 100 mm (W) × 30 mm (H) (3 15/16" × 1 3/16"), and the minimum size is 20 mm (W) × 5 mm (H) (25/32" × 7/32").

! • The barcode area may not be detected automatically in the following cases:

- When the space between barcodes is 5 mm (7/32") or less
- When the barcode image is not clear
- When the barcode is placed at an angle, or when the black bars are not straight
- When the bars are not true black (RGB 0.0.0)
- When the space between the bars is not true white (RGB 255.255.255)

3 Specify the barcode area.

Use  to surround the barcode on the screen.

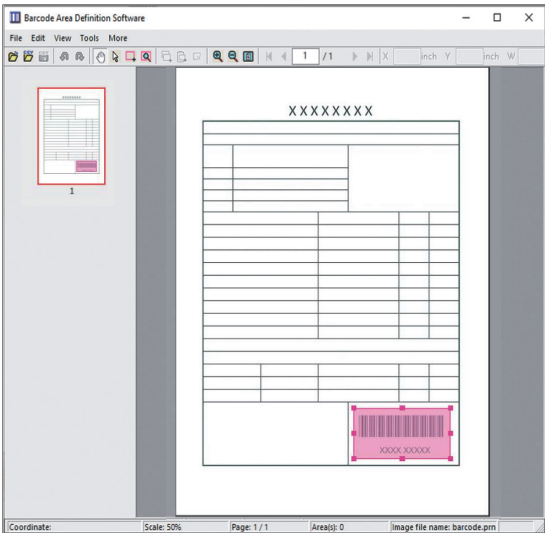

The enclosed area is colored and specified as the barcode area.

To edit the barcode area, use the edit tool and menu bar. (p.169 "Operations")

If automatic barcode area detection was used, make sure that the barcode was detected properly. If the detected area is not aligned with the barcode, use  (selection tool) to adjust the position.

■ Thumbnail Display

The top left corner of a thumbnail image is the base point, and the original image and barcode area definition image are displayed overlapping each other. If the original image and barcode area definition image are not the same size, a thumbnail like the one shown below is displayed. To specify a barcode area in the portion that is grayed out, align the original image and barcode area definition image in the same direction.



In this example, the original image (solid line) is smaller than the barcode area definition image (dotted line). The portion outside the barcode area definition image is grayed out.



- You can specify up to 50 barcodes per page on as many as 30 pages. If you specify [Repetition], you can apply areas repeatedly.
- Barcode areas can be moved on the same page using  (selection tool). To move barcode areas to a different page, copy and paste them to the desired page. You cannot paste the copied barcode area if it is larger than the original.

■ Precautions Regarding Barcode Area Definition

If the position information of the specified barcode area changes, such as when an image is rotated, the barcode area will not be processed correctly. If the image is rotated or the print direction is changed, use the creation tool to specify the barcode area again. (Correct the barcode area starting from the base point.)

Base point

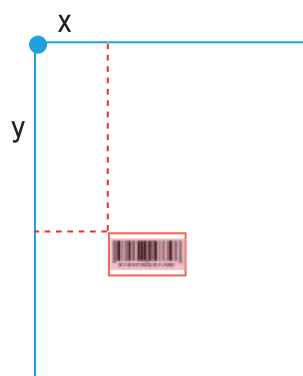

Example of when barcode processing is performed correctly

Base point

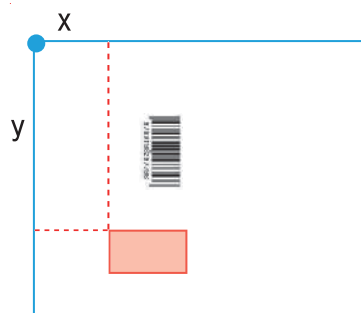

Example of when barcode processing is not performed correctly, because the original is rotated and the position of the barcode relative to the base point is changed

4 Save the barcode area definition file.

Click  in the menu bar. The barcode area definition file is output (saved) in CSV format. To change the file name when saving, select [Save As] in the [File] menu.



- The CSV file specifies the size (W, H) and position coordinates (X, Y) of the barcode on a printout (in 0.1 mm (0.004") units) relative to the base point, which is the top left corner of the original data created on a computer.

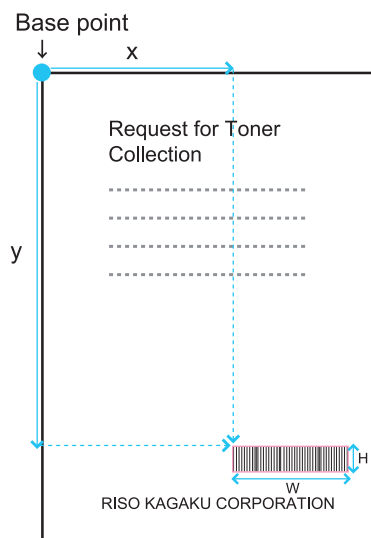

5 Register the barcode area definition file.











































Register the barcode area definition file to the printer in the administrator menu on the RISO Console. For more information, see the "Administrator's Guide".

Repetition Function

If you use the [Repetition] function when specifying the barcode areas, the areas are specified repeatedly for subsequent pages based on the value specified for [Cycle] in the [Repetition] dialog box. This eliminates the need to define the area on each and every page.

- When cycle is 0: The barcode areas are applied only on the pages that are configured in the barcode area definition file.
- When cycle is 1: The barcode areas configured for the first page in the barcode area definition file are repeated on each page until the last one.
- When cycle is 2: The barcode areas configured for the first 2 pages in the barcode area definition file are repeated on every 2 pages until the last one.
- When cycle is 3: The barcode areas configured for the first 3 pages in the barcode area definition file are repeated on every 3 pages until the last one.

In the example below, barcode areas are defined for 3 pages.

Original data	            
Barcode area definition	  
Cycle: 0	             <p>The pages that you configure in a barcode area definition file Barcode processing is not configured for pages 4 to 13.</p>
Cycle: 3	             <p>The pages that you configure in a barcode area definition file Repeated pages Repeated pages Repeated pages</p>



- You can specify from 1 to 999 pages for [Cycle].
- The pages after the ones set in the repetition process do not appear in the thumbnails.

Printing Barcode Originals

You can select a registered barcode area definition file from the [Barcode Area Definition] pull-down menu in the [Image] tab on the printer driver screen.

Select a suitable barcode area definition file when printing a barcode original. (p.124 "Barcode printing barcode originals")

Optional Equipment

This chapter describes the optional equipment that can be used with this machine.

Face Down Finisher

p.178

This section describes the settings and functions that are available when the face down finisher is connected.

Additional Tray

p.185

This section describes the settings and functions that are available when the additional tray is connected.

High Capacity Feeder

p.187

This section describes the settings and functions that are available when the high capacity feeder is connected.

Stacking Tray (Auto-control Stacking Tray / Wide Stacking Tray)

p.191

This section describes the settings and functions that are available when the auto-control stacking tray/wide stacking tray is connected.

High Capacity Stacker

p.195

This section describes the settings and functions that are available when the high capacity stacker is connected.

Multifunction Finisher

p.202

This section describes the settings and functions that are available when the multifunction finisher is connected.

PS Kit

p.218

This section describes the settings and functions that are available when the PS kit is installed.

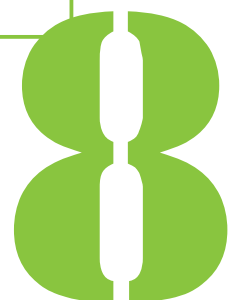

Face Down Finisher

If the optional face down finisher is connected, you can staple printed sheets, or perform offset output for each set of printed documents.

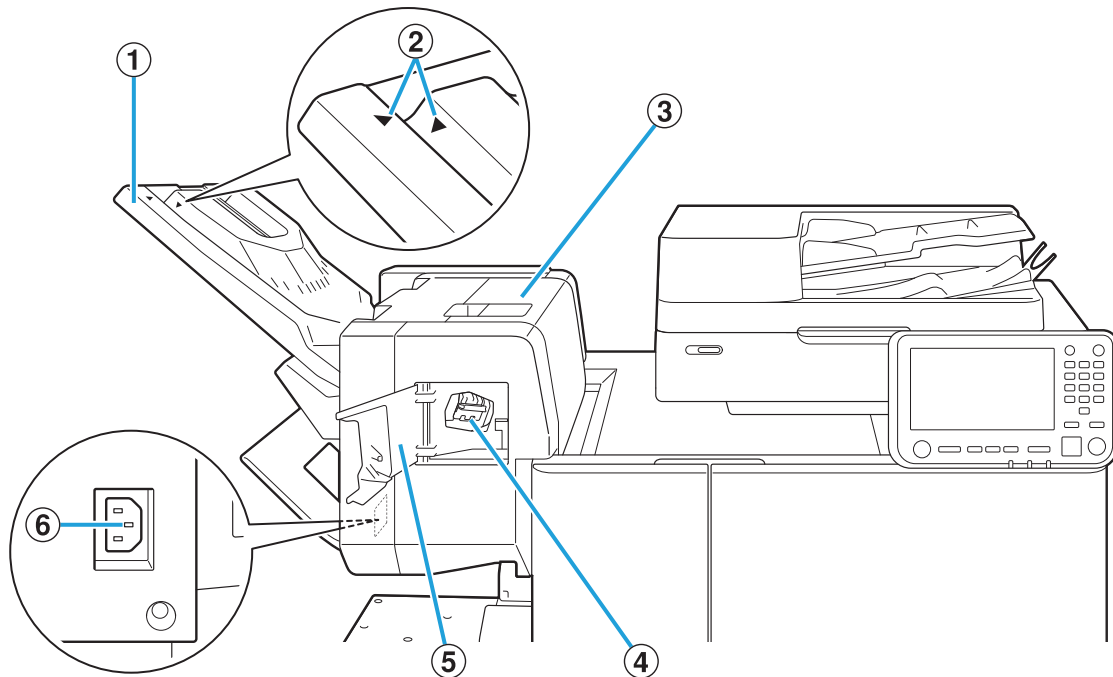

① Stacking Tray

Printouts are output face down.

② Stacking Tray Setting Position

Slide into position depending on the paper type or output condition.

③ Jam Release Cover

④ Staple Cartridge

Pull out the staple cartridge to replace staples, or if a staple is jammed.

⑤ Staple Cover

Open this cover if a staple is jammed, or to replace the staple cartridge.

⑥ Face Down Finisher Socket

Connect the face down finisher power cord.

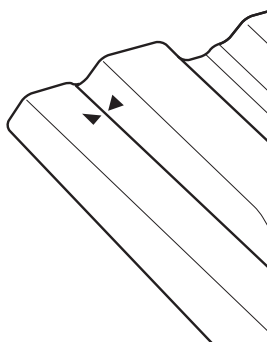
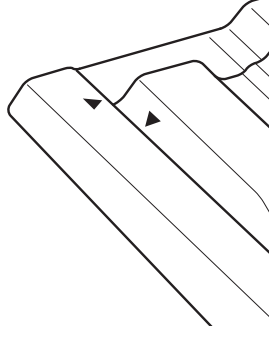

• The stacking tray slides. For normal output, align the [▶] and [◀] shown in ②.

Normal (except for the case shown on the right)	When using B5 or smaller paper without staples
 <p>Align [▶] and [◀].</p>	 <p>Position [▶] and [◀] apart from each other.</p>

Caution Label

For safety use, the caution label below is adhered to the face down finisher. When operating or maintaining the face down finisher, obey the instructions on the caution label for safe use. Do not remove or dirty the label. If the label is not stuck on the multifunction finisher, is peeling off, or is unreadable, contact your dealer or authorized service representative.

■ Location of the Caution Label

The location of the caution label (warning) is shown below.

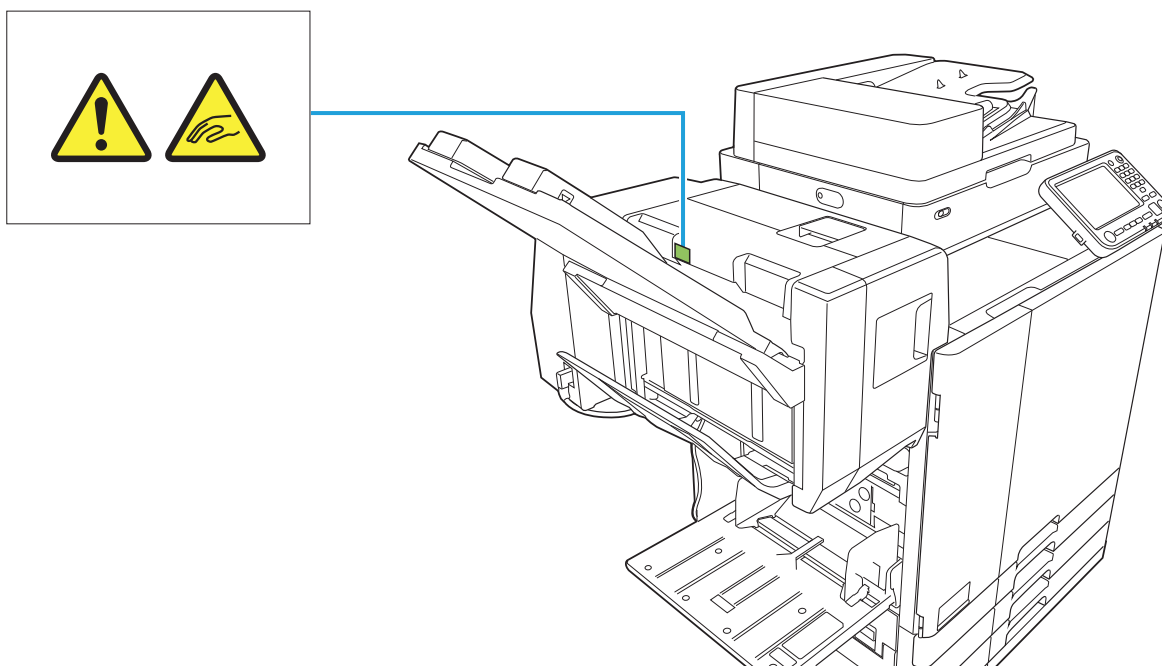

■ Label Details

Your fingers may become caught while the face down finisher moves or when you remove printouts from the stacking tray.

List of Settings

The items described below can be set when the face down finisher is connected.

Printer Driver

Setting item	Use this item to:	See
[Finishing] Tab		
Staple	Specify the stapling position.	p.180
Offset Output	Stack sets of printed documents slightly apart from one another when printing multiple copies.	p.183
[Advanced] Tab		
Program	Specify the number of copies by group (such as corporate division or class).	p.125
Offset Output (Program)	Stack sets of printed documents slightly apart from one another to create separation.	p.183



- When [Staple] is grayed out in the [Finishing] tab, make sure that [Printer Configuration] on the [Environment] tab has been configured correctly. (p.128 "Printer Configuration")

Copy Mode

Setting item	Use this item to:	See
Program	Specify the number of copies by group (such as corporate division or class).	p.74
Offset Output ([Program])	Stack sets of printed documents slightly apart from one another to create separation.	p.183
Separation	Specify where to insert slip sheets between printouts.	p.77

Setting item	Use this item to:	See
Offset Output ([Separation])	Stack sets of printed documents slightly apart from one another to create separation.	p.183
Staple	Specify the stapling position.	p.184

Printer Driver Settings

Staple

Specify the stapling position.



- When [Staple] is configured, make sure to configure [Binding Edge].
- When [Staple] is configured, [Sort] is set to [Collated]. (p.109 "Sort")
- When [Booklet] is configured, [Staple] is [OFF]. (p.114 "Booklet")
- The orientation of the paper varies depending on the binding edge. See "Staple Function and Loading Orientation of the Paper" (p.182)

If you select [Left] or [Right] for [Binding Edge], select from the following options:

[OFF], [1 Staple], [2 Staples]

If you select [Top] for [Binding Edge], select from the following options:

[OFF], [Left 1 Staple], [Right 1 Staple], [2 Staples]

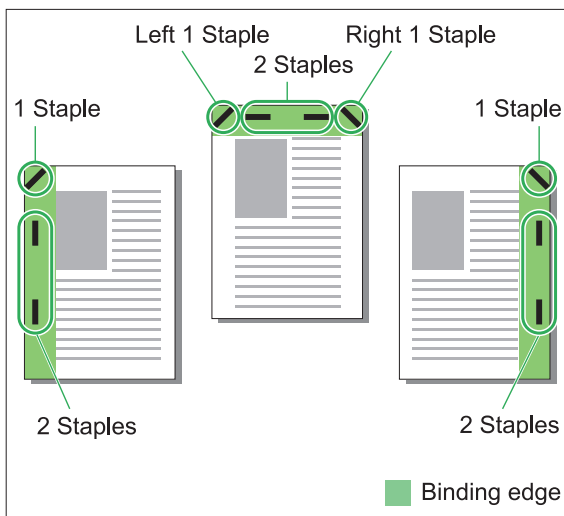

<Types of paper that can be stapled>

- Paper size: A3, B4, A4, A4-LEF, B5, B5-LEF, Ledger, Legal, Letter, Letter-LEF, Foolscap, 8K, 16K, 16K-LEF
- Paper weight: 52 g/m² - 210 g/m² (14-lb bond - 56-lb bond)

Number of sheets that can be stapled

- Standard size paper
A4, A4-LEF, B5, B5-LEF, Letter, Letter-LEF, 16K, 16K-LEF: 2 to 50 sheets*

Sizes other than the above (A3, B4, Ledger, Legal, Foolscap, 8K): 2 to 25 sheets*

* When using plain paper and recycled paper (85 g/m² (23-lb bond))



- LEF stands for "Long Edge Feed".
- Stapling cannot be performed when using irregular-sized paper.
- When the printing job exceeds the maximum number of sheets that can be stapled, a confirmation screen is displayed so that you can select whether to stop printing or continue printing without stapling.

Staple Function and Loading Orientation of the Paper

The orientation in which to load the paper in the paper tray (standard tray) and the stapling position are as listed below.

Orientation: Portrait

Orientation: Landscape

Face Up/Down: Face up

Face Up/Down: Face down

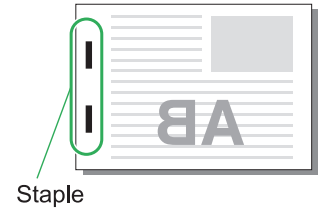
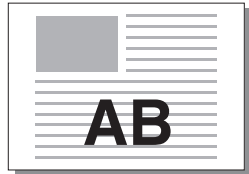
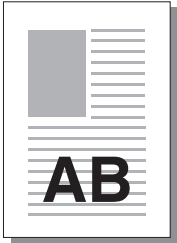

Binding Edge	Staple position					
	1 Staple		2 Staples			
Left						
Right						
Top	Left 1 Staple		Right 1 Staple		2 Staples	
Paper transfer			 Paper feed and output direction			



- When paper of the corresponding size is not loaded in the tray, a message will appear. Follow the displayed instructions and load the tray with paper.
- For [1 Staple], depending on the paper size and loaded direction, the angle of the staple may differ from the above drawing or the printing image shown on the printer driver screen.
- When multiple different original sizes are used in the original, the machine automatically rotates the image to suit the [Binding Edge] setting.

Offset Output

Stack sets of printed documents slightly apart from one another when printing multiple copies.



- When [Program] is configured, [Offset Output] is [OFF]. (p.125 "Program")
- This setting is not available for paper sizes that cannot be output to the face down finisher.
- When using the face down finisher, you cannot use this setting with stapling.

[OFF]

Offset output is not performed.

[Between Sorts]

Sets of printed documents specified in [Sort] are stacked slightly apart from one another.

[Between Jobs]

Finished print jobs are stacked slightly apart from one another.

Offset Output (Program)

In addition to the "Program" (p.125) function for printouts, you can stack sets of printed documents slightly apart from one another to create separation.

[OFF]

Offset output is not performed.

[Between Sets]

Each set of printed documents is stacked slightly apart from one another.

[Between Groups]

Groups of printed documents are stacked slightly apart from one another.

Copy Mode Settings

Offset Output ([Program])

In addition to the "Program" (p.74) function for copying, you can stack sets of printed documents slightly apart from one another to create separation.

[OFF]

Offset output is not performed.

[Between Sets]

Each set of printed documents is stacked slightly apart from one another.

[Between Groups]

Groups of printed documents are stacked slightly apart from one another.

Offset Output ([Separation])

In addition to the "Separation" (p.77) function for copying, you can stack sets of printed documents slightly apart from one another to create separation.



- You cannot use [Offset Output] and [Mixed Size Original] at the same time. (p.65 "Mixed Size Original")

[OFF]

Offset output is not performed.

[Between Sorts]

Each sorted set is stacked slightly apart from one another.

[After a Job]

Each print job is stacked slightly apart from one another.

<Paper that can be offset>

131 mm × 148 mm - 305 mm × 550 mm
(5 3/16" × 5 27/32" - 12" × 21 5/8")

- 1 Touch [Separation].
- 2 Select the offset output setting.
- 3 Touch [OK].

Staple

Staple at the specified position.

<Types of paper that can be stapled>

- Paper size: A3, B4, A4, A4-LEF, B5, B5-LEF, Ledger, Legal, Letter, Letter-LEF, Foolscap, 8K, 16K, 16K-LEF
- Paper weight: 52 g/m² - 210 g/m² (14-lb bond - 56-lb bond)

<Number of sheets that can be stapled>

- Standard size paper
A4, A4-LEF, B5, B5-LEF, Letter, Letter-LEF, 16K, 16K-LEF: 2 to 50 sheets*
- Sizes other than the above (A3, B4, Ledger, Legal, Foolscap, 8K): 2 to 25 sheets*

* When using plain paper and recycled paper (85 g/m² (23-lb bond))



- LEF stands for "Long Edge Feed".
- Stapling cannot be performed when using irregular-sized paper.
- When the printing job exceeds the maximum number of sheets that can be stapled, a confirmation screen is displayed so that you can select whether to stop printing or continue printing without stapling.
- The [Staple], [Booklet], [Page Border], and [Output Tray Relay] functions cannot be used at the same time. (p.68 "Booklet", p.71 "Page Border", p.79 "Output Tray Relay")

■ Original Orientation

[Top Side Up]

Select this option when loading originals in an orientation from which they can be read normally.

[Top Side Left]

Select this option when loading originals so that the top of the original is aligned with the left edge.

■ Binding Edge

Select the binding edge of the paper.

Left, Right, Top

■ Staple

Specify the stapling position.

If you select the left or the right for [Binding Edge], select from the following options:

[OFF], 1 staple, 2 staples

If you select the top for [Binding Edge], select from the following options:

[OFF], left 1 staple, right 1 staple, 2 staples



- The left 1 staple and the right 1 staple are displayed only when the top is selected for [Binding Edge].

1 Touch [Staple].

2 Configure [Binding Edge].

3 Configure [Staple].

4 Touch [OK].

■ Binding Margin

You can specify the binding margin so that staples are not in the printing area.

1 Touch [Binding Margin] on the [Staple] screen.

The [Binding Margin] screen is displayed.

2 Specify the binding margin.

- Select [Binding Edge].
- Use [▼], [▲], or the numeric keys to enter the width.
- If part of the printing area is missing due to the binding margin setting, set [Auto Reduction] to [ON].

3 Touch [OK].

Additional Tray

When the optional additional tray is attached, you can load approx. 2,000 sheets of printing paper (when using plain paper and recycled paper (85 g/m² (23-lb bond))).

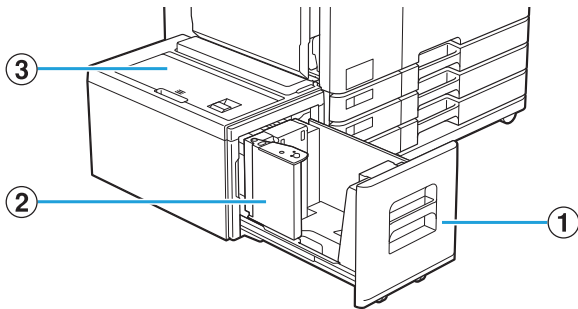

① Feed Tray

Load the paper to be used for printing here.



• Use the standard tray for thick paper and other special paper types.

② Paper guide

Paper guide prevents paper in the additional tray from becoming misaligned.

③ Top cover

If a paper jam occurs, open this cover to remove the jammed sheet.

Loading the Paper



• When changing the paper size (paper guide position), contact your dealer or authorized service representative.

1 Pull a tray out, toward the front.

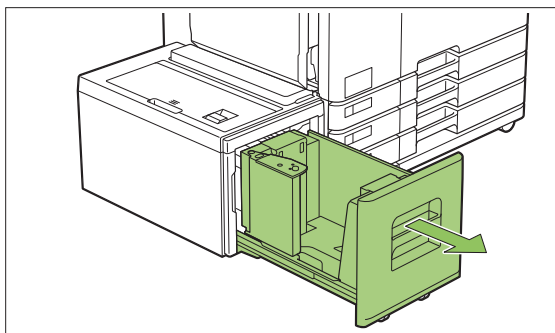

• To prevent a paper jam, check the following before pulling a tray out.

- There is no paper in the tray.
For more information on the remaining amount of paper, see "Consumables Screen" (p.41).
- There is no job using the additional tray to feed paper.
For the job being printed, see "[Paper info] Screen" (p.53).

2 Open the paper guide.

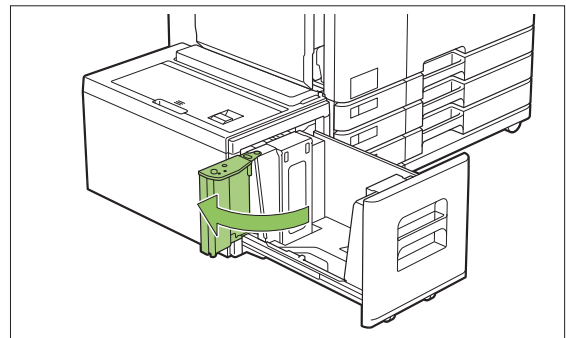

3 Load the paper.

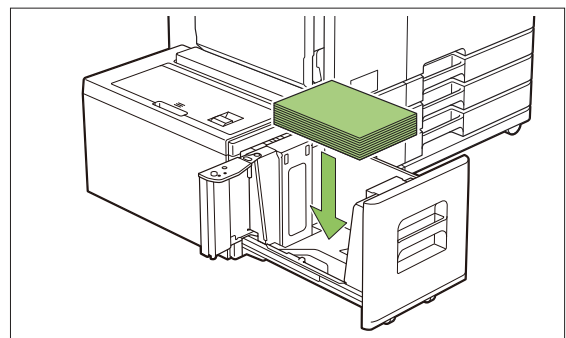

- 4 Push the paper guide back until it is aligned against the outside edge of paper.**

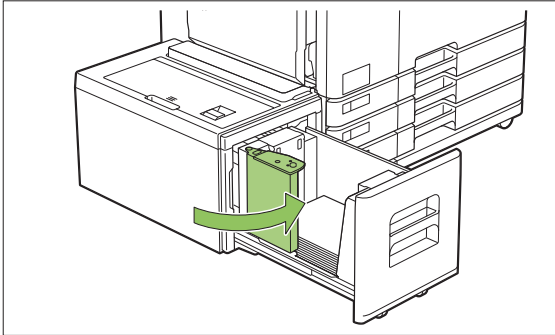

- 5 Push the tray back into the machine.**

High Capacity Feeder

By connecting the optional high capacity feeder, it is possible to load the unit with approximately 4,000 sheets of printing paper (when using plain paper, recycled paper).

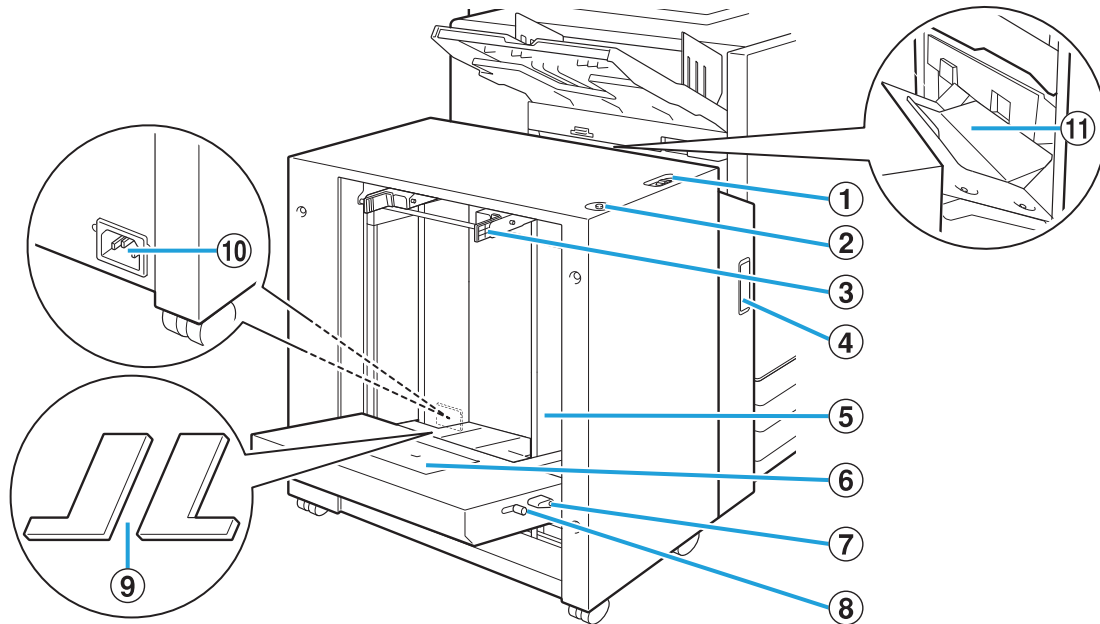

① Paper Feed Pressure Adjustment Lever

Use this lever to adjust the paper feed pressure for either "NORMAL" or "CARD" to suit the paper type loaded in the high capacity feeder.

② Standard Tray Descent Button

Use this button to move the high capacity feeder up or down when replacing or adding the paper to it.

③ Paper Feed Guide Levers

Pinch these levers to slide the paper feed guide. Release the levers to fix the paper feed guide in position. Levers are located on both sides of the standard tray paper guide, in two places.

④ Front Cover

Open this cover when there is a paper jam.

⑤ Standard Tray Paper Guide

This guide prevents paper in the high capacity feeder from becoming misaligned.

⑥ Envelope Guide

Use this guide when printing on an envelope. Depending on the type of envelope being used, it is necessary to adjust the angle of inclination.

⑦ Envelope Guide Angle Adjustment Lever

Use this lever to adjust the angle of inclination of the envelope guide. The angle of the envelope guide can be adjusted to four levels.

⑧ Envelope Guide Paper Feed Pressure Adjustment Lever

Use this lever to adjust the paper feed pressure to suit the paper quality of the envelope being used.

⑨ Standard Tray Padding Covers

Remove the covers when you load sheets smaller than A4 (Letter) or larger than A3 (Ledger), or C5/DL-LEF envelopes.

⑩ High Capacity Feeder Socket

Connect the high capacity feeder power cord. The socket is located on the right side in the rear of the standard tray.



The standard tray cannot be used when the high capacity feeder is connected.

⑪ Transfer Cover

If a paper jam occurs, open this cover and remove the jammed sheet.

Loading the Paper

1 Spread the paper feed guides.

Pinch the paper feed guide levers (both sides) to unlock and slide the guides.

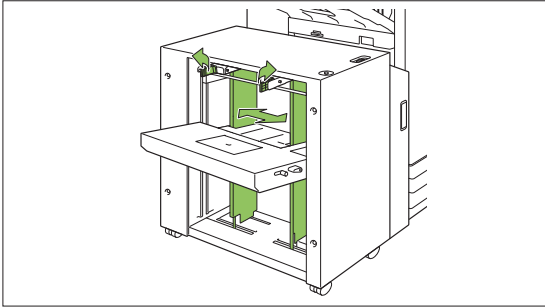

2 Load the paper.

Load the paper with the printing side face up.

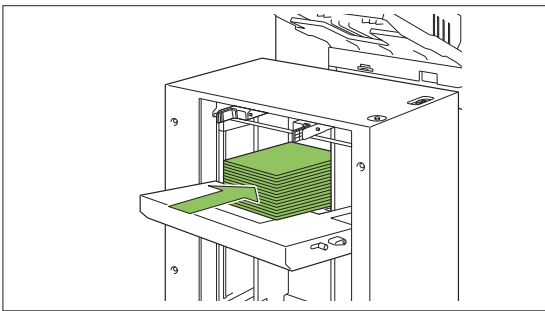

- When a large amount of paper is loaded at once, it is difficult to properly adjust the guides and may prevent the paper from being loaded correctly. (The paper may bend, warp, or be misaligned.) Divide the paper into several bulks when loading the paper. When setting a large amount of paper at once, see "When Setting a Large Amount of Paper at Once" (p.190).
- Be sure to load envelopes with their flaps open and their bottom side entering the machine first. The adjustment of the angle of inclination of the envelope guide is configured using the envelope guide angle adjustment lever.

Note that it is also necessary to adjust the paper feed pressure depending on the paper quality of the envelopes being used. Configure the pressure with the envelope guide paper pressure adjustment lever. Slide the lever while lifting it up. See the sticker near the lever to set a pressure that is appropriate for the envelopes being used.

Keep this surface level

Envelope guide paper feed pressure adjustment lever

- ✗ Envelopes of thick paper
- ✗ Envelopes of thin paper
- ✗ Paper other than envelopes

Envelope guide angle adjustment lever

- ✗ Envelopes of thin paper or paper
- ✗ Thick paper or long envelopes

3 Adjust the paper feed guides so that they are suitable for the paper size.

Slide the guides while pinching the paper feed guide levers to match the guides against the edges of the paper, and release the paper feed guide levers to fix the guides in position.

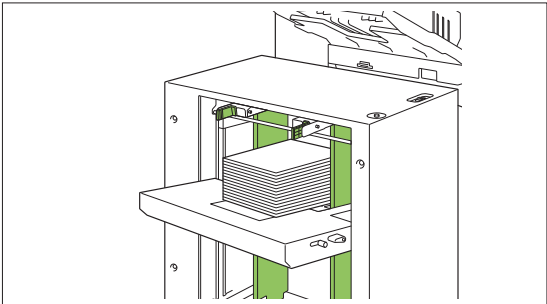

4 Adjust the paper feed pressure adjustment lever.

For general use, set to "NORMAL". For thick paper or other paper for special purposes, set to "CARD".

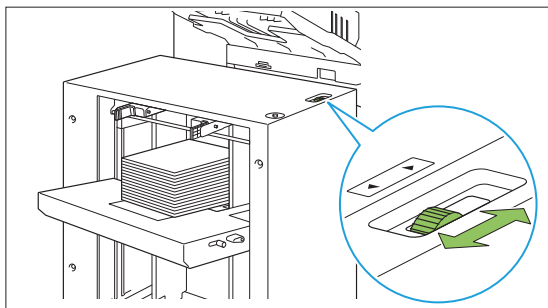

5 On the operation panel, check the tray settings.

Configure the paper size and type with [Paper Tray]. When changing the paper loaded in a tray, be sure to change the settings in [Paper Tray].

Regarding the Standard Tray Padding Covers

Depending on the size of the paper being used, the standard tray padding covers may or may not be necessary.

■ Cases When the Standard Tray Padding Covers Are Necessary

Properly attach and use the standard tray padding covers when the paper size is B5-LEF, A4-LEF, B4, A3, or a custom size having a width of 257 mm (10 1/8") or more.

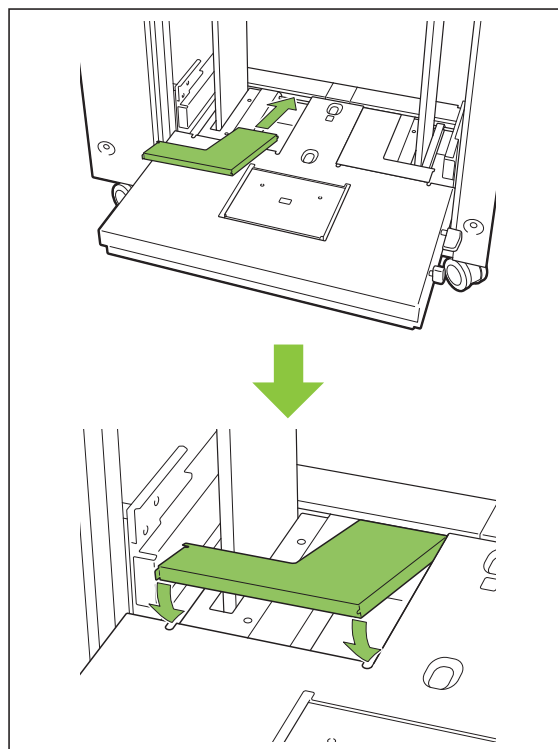

■ Cases When the Standard Tray Padding Covers Are Not Necessary

When the size of the paper is less than A4 vertically or more than A3, or when using envelopes of the C5 or DL-LEF size, remove the standard tray padding cover. The paper feed guide cannot be moved while the cover is in place.

When Setting a Large Amount of Paper at Once

- 1 **Spread the paper feed guides and load approximately 500 sheets onto the standard tray.**
- 2 **Adjust the paper feed guides so that they are suitable for the paper size.**
Move the guides against the edges of the paper, and release the lever to lock.
- 3 **Load the rest of the paper.**
Procedures after all of the paper has been loaded are the same as when loading the paper for normal operation. Perform step 4 and 5 described in "Loading the Paper" (p.188).

Adding the Paper

Use the standard tray descent button when adding the paper. The position to which the standard tray is lowered will differ depending on how the standard tray descent button is operated. Note that the standard tray is automatically lowered when all paper is removed.

- 1 **Press the standard tray descent button to lower the standard tray.**
Hold down the standard tray descent button.
The standard tray will keep lowering for as long as the button is being pressed. Hold the button down until the tray reaches the desired position.
Press and quickly release the standard tray descent button.
The standard tray will be lowered to a certain position.

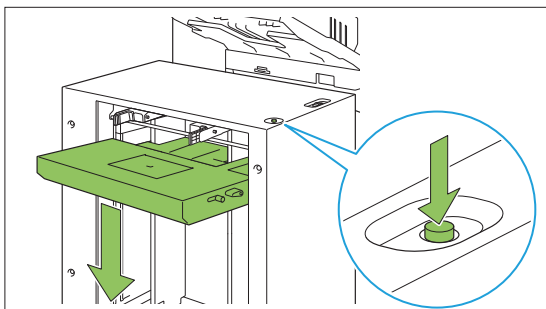

- The position to which the standard tray is lowered when the standard tray descent button is pressed or when paper runs out is set by the administrator. Contact your administrator for details.
- When the standard tray is lowered to the lowermost position, it is possible to load a large amount of paper at once but this will require that you squat when loading the paper. To load the paper while standing or when it is rare that you need to load a large amount of paper at once, avoid lowering the standard tray to the lowermost position.
- The position to which the standard tray is lowered can be conveniently configured to suit scenes of use. To change the position to which the standard tray is lowered, contact your administrator.

2 Add the Paper.

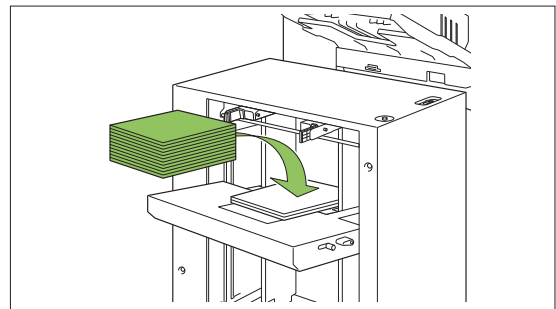

When Adding a Large Amount of Paper

It is possible to set a greater amount of paper at once by holding down the standard tray descent button and lowering the standard tray to its lowermost position.



- The position to which the standard tray is lowered when the standard tray descent button is pressed shortly or when paper runs out is set by the administrator. To change the position to which the standard tray is lowered, contact your administrator.

Stacking Tray (Auto-control Stacking Tray / Wide Stacking Tray)

The auto-control stacking tray and wide stacking tray are available as optional stacking trays.

- With the auto-control stacking tray, the paper guides adjust automatically to fit the paper size.
- With the wide stacking tray, move the paper guides (side and end) to match the paper size.

<The auto-control stacking tray is shown in the illustration below.>

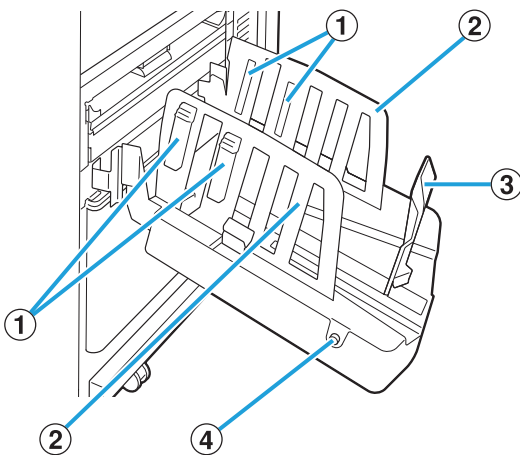

① Paper Arrangers

Set to suit the paper type so that the output paper is neatly aligned.

② Paper Guide (side)

③ Paper Guide (end)

Use to prevent output paper in the stacking tray from becoming misaligned.

④ Paper Guides Open Button (Auto-control stacking tray only)

Use to spread the paper guides apart. Operation varies depending on whether paper is present or not.

- When the machine is idle and there is no paper in the stacking tray, the guides open to the loading position.
 - When the machine is idle and there is paper in the stacking tray, the paper guides spread apart, making it easy to remove the paper.
- The administrator can configure which paper guides spread apart when the button is pressed.

Loading the Stacking Tray

Follow the procedure below to load the stacking tray. Depending on the paper size or type, you can also adjust the paper arranger at this time.



- The auto-control stacking tray is shown in the illustrations below.
- When using the wide stacking tray, manually adjust the positions of the paper guides (side and end) to match the paper size.

1 Open the stacking tray in the direction of the arrow until it stops.

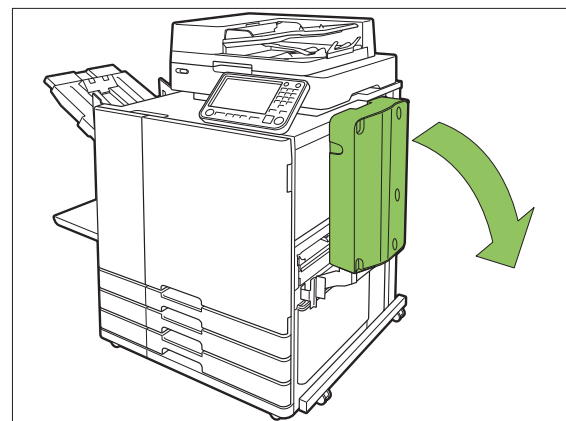

2 Lift the paper guides (side) to stand them upright.

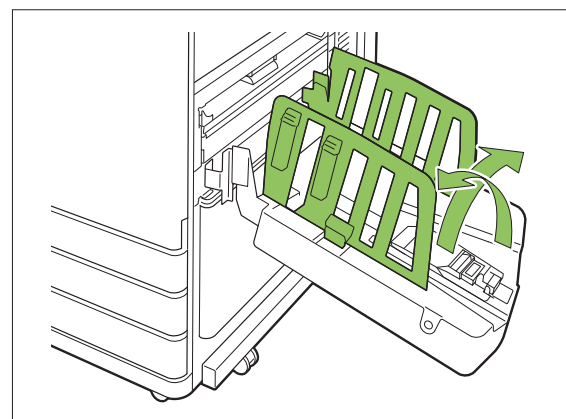

3 Adjust the paper arranger.

Normally, the paper arranger should be extended when printing on paper that is B4 size or smaller. How paper is stacked after printing varies depending on stiffness and other factors. Adjust the paper arranger as needed.

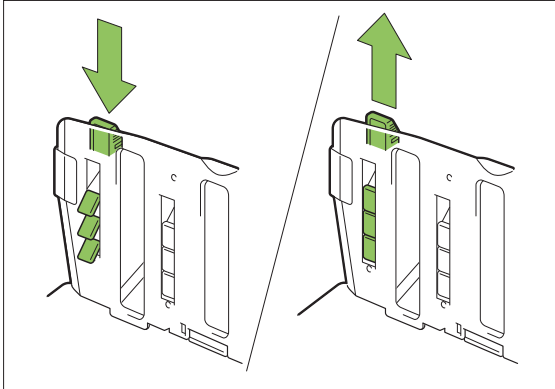

4 Lift the paper guide (end) to stand it upright.

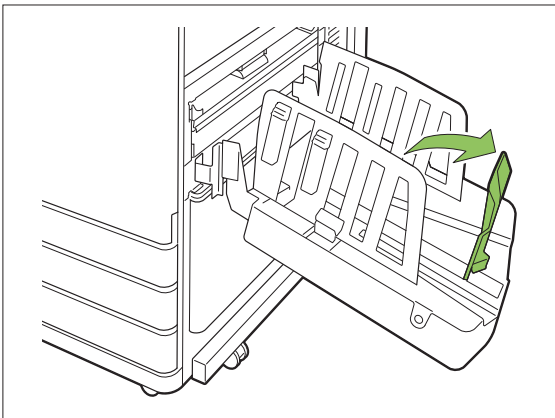

- Fold all paper guides when printing on paper larger than 320 mm × 432 mm (12 19/32" × 17").

Closing the Stacking Tray

1 After confirming that there are no printouts in the stacking tray, press the paper guides open button.

The paper guides (side and end) now move into position for storage.

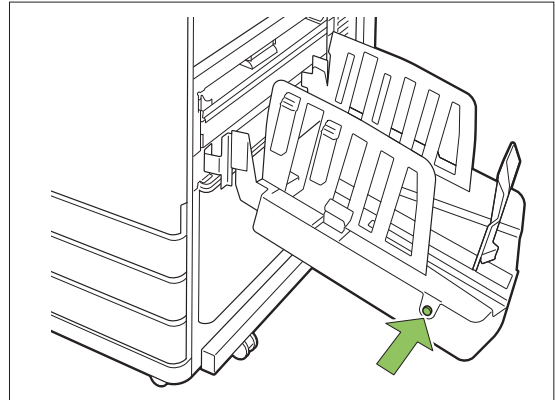

2 Lower the paper guide (end) toward the stacking tray to fold it up.

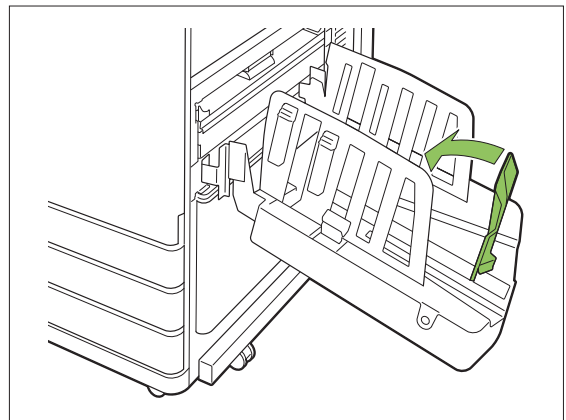

3 Fold up the paper arranger.

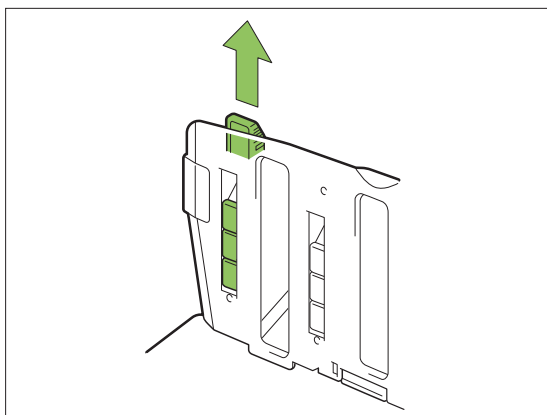

4 Lower the paper guides (side) inward, and then close the stacking tray.

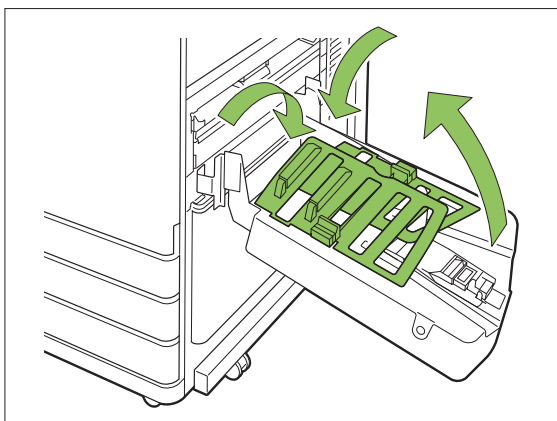

List of Settings

The items described below can be set when the stacking tray is connected.

Printer Driver

Setting item	Use this item to:	See
[Finishing] Tab		
Output Tray	Select the output tray for printouts.	p.193
Output Tray Relay	Switch the output tray automatically when the output tray becomes full.	p.193

Copy Mode

Setting item	Use this item to:	See
Output Tray	Select the output tray for printouts.	p.194
Face Up/Down	Specify whether to stack the pages face up or face down in the stacker.	p.194
Output Tray Relay	Switch the output tray automatically when the output tray becomes full.	p.194

Maintenance Mode

Setting item	Use this item to:	See
Paper Guide Control	Adjust the position of the paper guides of the auto-control stacking tray.	p.194

Printer Driver Settings

Output Tray

Specify the output tray for printouts. When [Auto] is specified, printouts are output to the appropriate tray automatically based on the configured functions. To output printouts to the stacking tray, select [Auto-control Stacking Tray] or [Wide Stacking Tray].

Click [Details] to display the [Output Tray] dialog box. Specify whether to stack the pages face up or face down in the stacker. **[Face Up], [Face Down]**

Output Tray Relay

The output tray switches automatically when the tray is full.



- This setting is not available when using the wide stacking tray.
- When [Output Tray Relay] is configured, [Sort] is set to [Uncollated] in the [Basic] tab. (p.109 "Sort")

- [Output Tray Relay] and [Add Cover] cannot be used at the same time. (p.119 "Add Cover")

Copy Mode Settings

Output Tray

Select the output tray for printouts.



- The tray details displayed on the [Output Tray] screen vary depending on the optional equipment that is connected.

[Auto]

The appropriate tray is selected automatically.

[①Face Down Tray], [②Auto-control Stacking Tray], or [②Wide Stacking Tray]

Select the output tray.

- 1 Touch [Output Tray].
- 2 Select the output tray.
- 3 Touch [OK].

Face Up/Down

Specify whether to stack the pages face up or face down in the stacker.

[Face Up], [Face Down]

Output Tray Relay

The output tray switches automatically when the tray that is being used becomes full.

- 1 Touch [Output Tray Relay].
- 2 Touch [ON].
- 3 Touch [OK].



- This setting is not available when using the wide stacking tray.
- When [Output Tray Relay] is configured, [Sort] is set to [Uncollated]. (p.64 "Sort")
- [Output Tray Relay], [Booklet], and [Add Cover] cannot be used at the same time. (p.68 "Booklet", p.77 "Add Cover")

Maintenance Mode Settings

Paper Guide Control

Adjust the position of the paper guides of the auto-control stacking tray. For more information, see "Paper Guide Control" (p.240) in the "Appendix".

High Capacity Stacker

By connecting the high capacity stacker, it is possible to output approximately 4,000 sheets of printing paper (when using plain paper, recycled paper).

The printouts that have been output can be removed at once with the dedicated carriage.

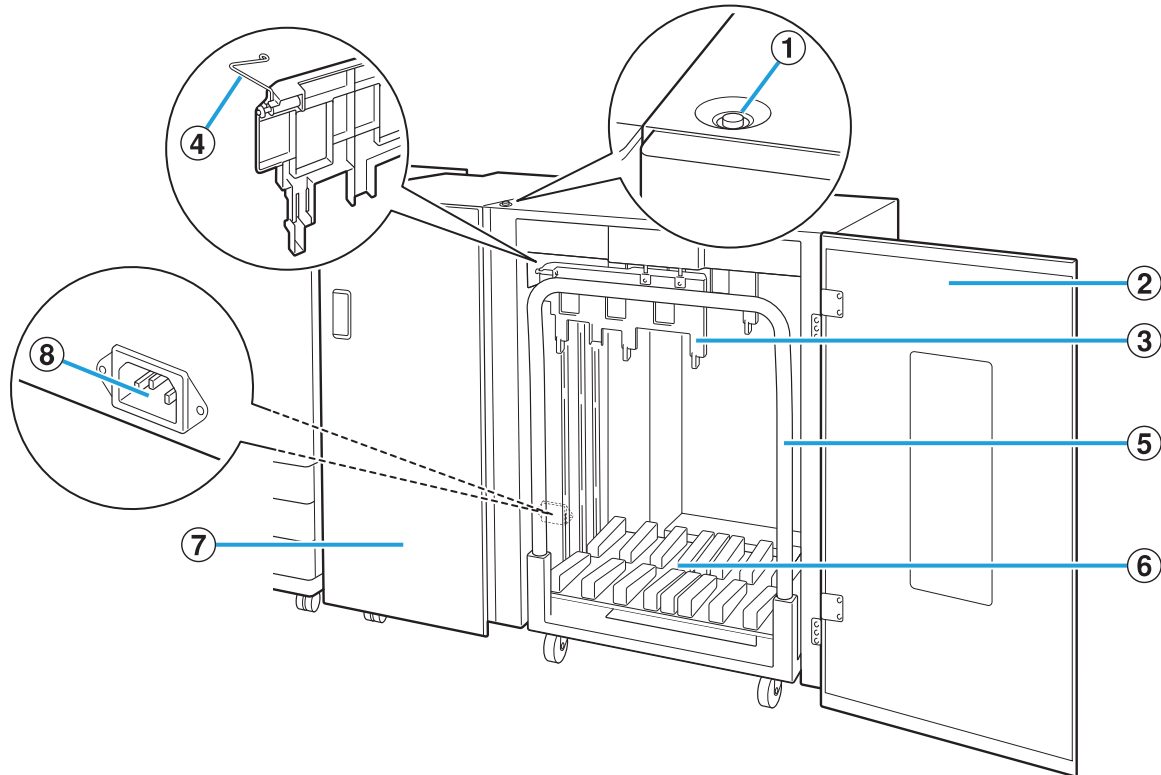

① Stacking Tray Descent Button

Press this button to remove printouts from the stacking tray. If you press the stacking tray descent button, the stacking tray lowers to the bottom (the position of the carriage). The stacking tray stops when you press the stacking tray descent button during lowering. If you press the button again, the stacking tray continues lowering. The stacking tray does not operate during printing even if you press the stacking tray descent button. Press with the right and left covers closed.

② Right Cover

Open this cover when removing printouts, setting the carriage in position, or when removing paper jams.

③ Paper Guide

Use this guide to prevent printouts that have been output from becoming misaligned.

④ Corrugators

Set the corrugators to feed paper smoothly according to the paper type and align printouts to stack neatly.

⑤ Carriage

Set this dedicated carriage inside the high capacity stacker. Connect the stacking tray to the carriage to transport high-volume printouts.

⑥ Stacking Tray

Printouts are output to this tray.

⑦ Left Cover

If a paper jam occurs while paper is being transported, open this cover and remove the jammed paper.

⑧ High Capacity Stacker Socket

Connect the high capacity stacker power cord. The socket is located toward the bottom on the rear of the left cover.



- Do not open the cover during printing. You cannot print with the cover open.
- Be sure to use the dedicated carriage with the high capacity stacker.

Setting the Corrugators

As the state of paper transport and alignment will differ depending on the size or type of paper being used, adjust the corrugators so that the output and paper of printouts will be aligned.



- Normally, it will not be necessary to adjust the corrugators for printing. Adjust the corrugators for better feeding and printout alignment.
- Paper alignment may not improve according to the paper size, paper type, environment and storage. For more information, contact your dealer or authorized service representative.

Raising the Corrugators

Normally, the unit is used with the corrugators raised.

- 1 Lift the front corrugator while pressing it toward the machine (to the left).

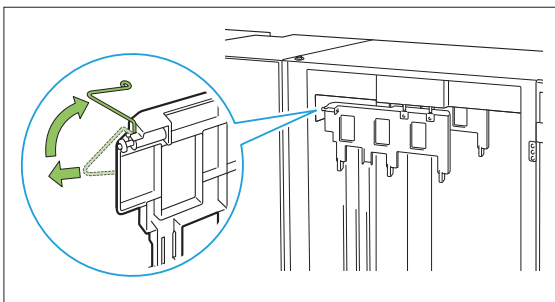

- 2 Similarly lift the back corrugator while pressing it toward the machine (to the left).

Lowering the Corrugators

The unit is used with the corrugators lowered when printing on A3/B4/B5-LEF paper or thin paper.

- 1 Lower the front corrugator while pressing it toward the machine (to the left).

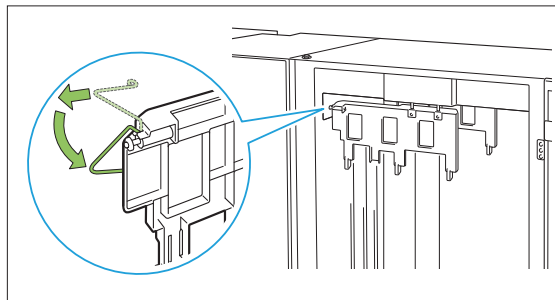

- 2 Similarly lower the back corrugator while pressing it toward the machine (to the left).

Removing Printouts

Remove printouts from the high capacity stacker. There are two ways of removing the printouts.



- The printouts are to be removed when the stacking tray is at a full stop. A message indicating the status of the stacking tray is displayed on the operation panel. Follow the message.

- **When removing printouts with the carriage**
Remove printouts using the dedicated carriage for the high capacity stacker.
- **When removing only the printouts**
Printouts can be removed without pulling out the dedicated carriage. You can remove printouts without waiting for the stacking tray to lower to the bottom.

When Removing Printouts With the Carriage

1 Press the stacking tray descent button.

The stacking tray will be automatically lowered to its lowest position after approximately 3,200 to 4,000 (full) sheets have been output.

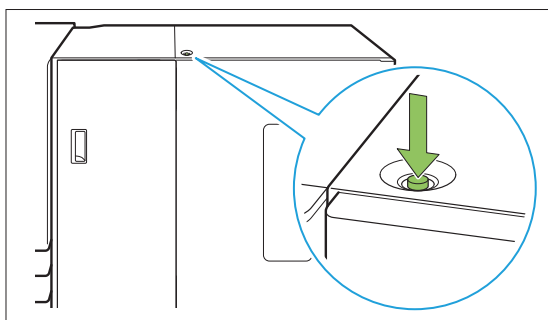

- Press the stacking tray descent button in a state where the covers on both sides of the high capacity stacker are closed. The stacking tray will not operate if the covers are open.
- Once printing has ended, the stacking tray will be automatically lowered to a position configured by the administrator. To change the position to which the stacking tray is lowered, contact your administrator.
- If you accidentally press the stacking tray descent button while printing, be sure to remove the printouts. In a state where printouts exist on the tray, the unit will not be capable of raising the stacking tray to the position for output.

2 Open the right cover of the high capacity stacker.

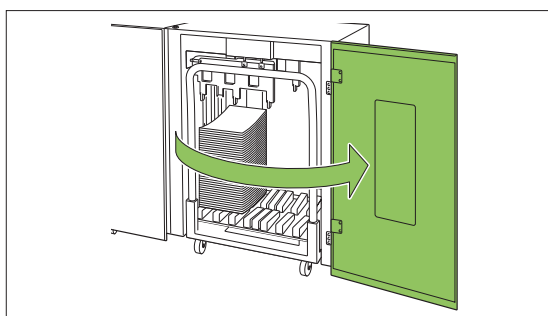

3 Pull out the carriage along with the stacking tray on it.



- Slowly pull out the carriage while holding its handle. Abruptly moving the cart may cause the printouts to collapse.

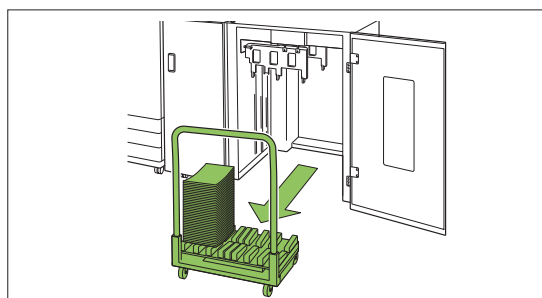

4 Remove printouts from the carriage.

5 Return the carriage to the high capacity stacker.



- Be sure to return the carriage in a state where the stacking tray has been set.

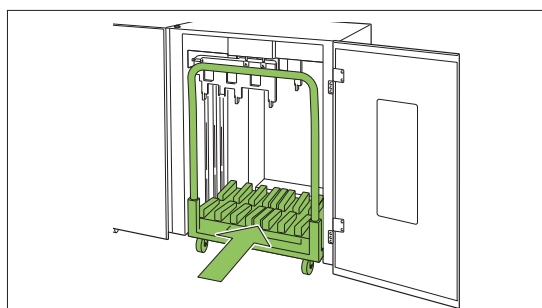

6 Close the right cover of the high capacity stacker.

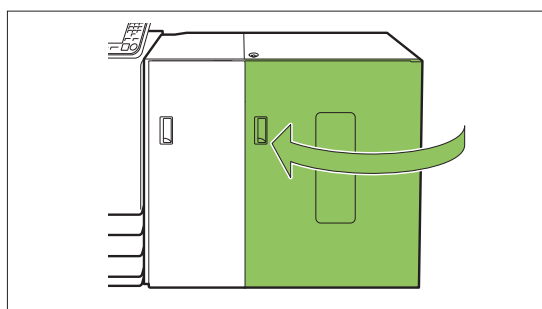

When Removing Only the Printouts

1 Open the right cover of the high capacity stacker.

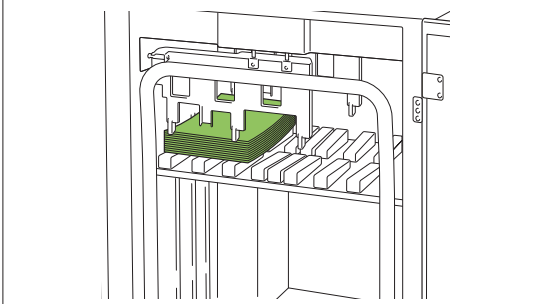

- The position at which the stacking tray will stop is configured by the administrator. To change the position to which the tray is lowered, contact your administrator.
- Depending on the position at which the stacking tray will stop, the printouts may interfere with the guides making it difficult to be removed. In such case, close the right cover, press the stacking tray descent button, and remove the printouts after the stacking tray has been lowered.

2 Remove the printouts.



- Depending on the size of the paper that has been output, the printouts may interfere with the handle of the carriage making it difficult to be removed. In such case, close the right cover, press the stacking tray descent button, and lower the stacking tray to the carriage. This will allow you to pull out the entire carriage and remove the paper.

3 Close the right cover of the high capacity stacker.



- If the carriage has been pulled out in step 2, close the right cover after setting the carriage back into the high capacity stacker.
- When configured so that the stacking tray is not lowered even after printing has ended, if there is paper on the stacking tray, the output guide is unable to move and may not be able to support the size of paper for the next job. Before printing jobs of different paper sizes, paper orientations, or paper tray settings, be sure to remove the paper on the stacking tray.

Setting the Stacking Tray on the Carriage

The stacking tray can be removed from the carriage. When you have removed the stacking tray to remove printouts, set the stacking tray on the carriage and return the high capacity stacker together with the carriage.

1 Align the end of the stacking tray with the two screws at the base of the handle on the carriage.

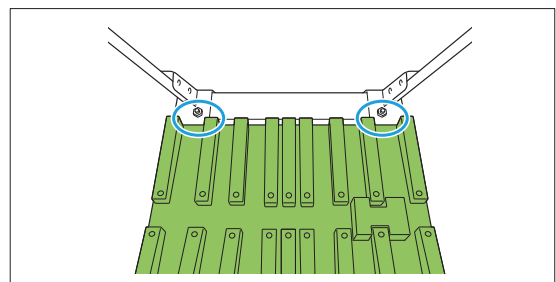

2 Set the carriage by inserting its protrusions into the holes in the stacking tray.

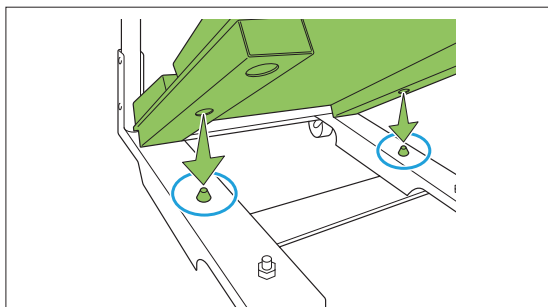

List of Settings

The items described below can be set when the high capacity stacker is connected.

Printer Driver

Setting item	Use this item to:	See
[Finishing] Tab		
Offset Output	Stack sets of printed documents slightly apart from one another when printing multiple copies.	p.199
Output Tray	Select the output tray for printouts.	p.200
Output Tray Relay	Switch the output tray automatically when the output tray becomes full.	p.200
[Advanced] Tab		
Program	Specify the number of copies by group (such as corporate division or class).	p.125
Offset Output (Program)	Stack sets of printed documents slightly apart from one another to create separation.	p.200



- When [Offset Output] and [Output Tray] are grayed out on the [Finishing] tab, make sure that [Printer Configuration] on the [Environment] tab has been configured correctly. (p.128 "Printer Configuration")

Copy Mode

Setting item	Use this item to:	See
Program	Specify the number of copies by group (such as corporate division or class).	p.74
Offset Output ([Program])	Stack sets of printed documents slightly apart from one another to create separation.	p.200
Separation	Specify where to insert slip sheets between printouts.	p.77
Offset Output ([Separation])	Stack sets of printed documents slightly apart from one another to create separation.	p.200
Output Tray	Select the output tray for printouts.	p.201
Face Up/Down	Specify whether to stack the pages face up or face down in the stacker.	p.201
Output Tray Relay	Switch the output tray automatically when the output tray becomes full.	p.201

Maintenance Mode

Setting item	Use this item to:	See
Paper Guide Control	Adjust the position of the paper guides.	p.240

Printer Driver Settings

Offset Output

Stack sets of printed documents slightly apart from one another when printing multiple copies.



- When [Program] is configured, [Offset Output] is [OFF]. (p.125 "Program")
- This setting is not available for paper sizes that cannot be output to the high capacity stacker.

- When [Mixed Size Original] is configured, [Offset Output] is [OFF]. (p.109 "Mixed Size Original")

[OFF]

Offset output is not performed.

[Between Sorts]

Sets of printed documents specified in [Sort] are stacked slightly apart from one another.

[Between Jobs]

Finished print jobs are stacked slightly apart from one another.

Output Tray

Specify the output tray for printouts.

When [Auto] is specified, printouts are output to the appropriate tray automatically based on the configured functions. Select [High Capacity Stacker] to output materials to the high capacity stacker.

Click [Details] to display the [Output Tray] dialog box. Specify whether to stack the pages face up or face down in the stacker.

[Face Up], [Face Down]



- When [Offset Output] or [Staple] is configured, the output trays that can be selected with [Output Tray] will differ depending on the configured details. (p.212 "Offset Output", p.206 "Staple")

Output Tray Relay

The output tray switches automatically when the tray is full. Specify the output tray for printouts. You must set [Sort] to [Uncollated] in the [Basic] tab.

Offset Output (Program)

In addition to the "Program" (p.125) function for printouts, you can stack sets of printed documents slightly apart from one another to create separation.

[OFF]

Offset output is not performed.

[Between Sets]

Each set of printed documents is stacked slightly apart from one another.

[Between Groups]

Groups of printed documents are stacked slightly apart from one another.

Copy Mode Settings

Offset Output ([Program])

In addition to the "Program" (p.74) function for copying, you can stack sets of printed documents slightly apart from one another to create separation.

[OFF]

Offset output is not performed.

[Between Sets]

Each set of printed documents is stacked slightly apart from one another.

[Between Groups]

Groups of printed documents are stacked slightly apart from one another.

Offset Output ([Separation])

In addition to the "Separation" (p.77) function for copying, you can stack sets of printed documents slightly apart from one another to create separation.



- You cannot use [Offset Output] and [Mixed Size Original] at the same time. (p.65 "Mixed Size Original")

[OFF]

Offset output is not performed.

[Between Sorts]

Each sorted set is stacked slightly apart from one another.

[After a Job]

Each print job is stacked slightly apart from one another.

<Paper sizes that can be offset>

- A3, B4, A4, A4-LEF, B5, B5-LEF, Ledger, Legal, Letter, Letter-LEF, Foolscap, Specified Size (length of paper between 182 mm (7 3/16") to 432 mm (17"))

- 1 Touch [Separation].
- 2 Select the offset output setting.
- 3 Touch [OK].

Output Tray

Select the output tray for printouts.



- The tray details displayed on the [Output Tray] screen vary depending on the optional equipment that is connected.

[Auto]

The appropriate tray is selected automatically.

[①Face Down Tray], [②High Capacity Stacker]

Select the output tray.

- 1 Touch [Output Tray].
- 2 Select the output tray.
- 3 Touch [OK].

Face Up/Down

Specify whether to stack the pages face up or face down in the stacker.

[Face Up], [Face Down]

Output Tray Relay

The output tray switches automatically when the tray that is being used becomes full.

- 1 Touch [Output Tray Relay].
- 2 Touch [ON].
- 3 Touch [OK].



- [Output Tray Relay], [Booklet], and [Add Cover] cannot be used at the same time. (p.68 "Booklet", p.77 "Add Cover")

Maintenance Mode Settings

Paper Guide Control

Adjust the position of the paper guides. For more information, see "Paper Guide Control" (p.240) in the "Appendix".

Multifunction Finisher

You can do the following when using the optional multifunction finisher.

Functions available for Multifunction Finisher	Functions available when adding optional equipment		
	With Folder Unit	With Punch Unit (2/3H)	With Punch Unit (2/4H)
Staple Bi-fold Booklet Binding	Inner Tri-fold Outer Tri-fold Z-fold	2- or 3-hole punch	2- or 4-hole punch

This section is explained using a multifunction finisher with a folder unit and a punch unit (2/4H) as an example.

- As seen from the front

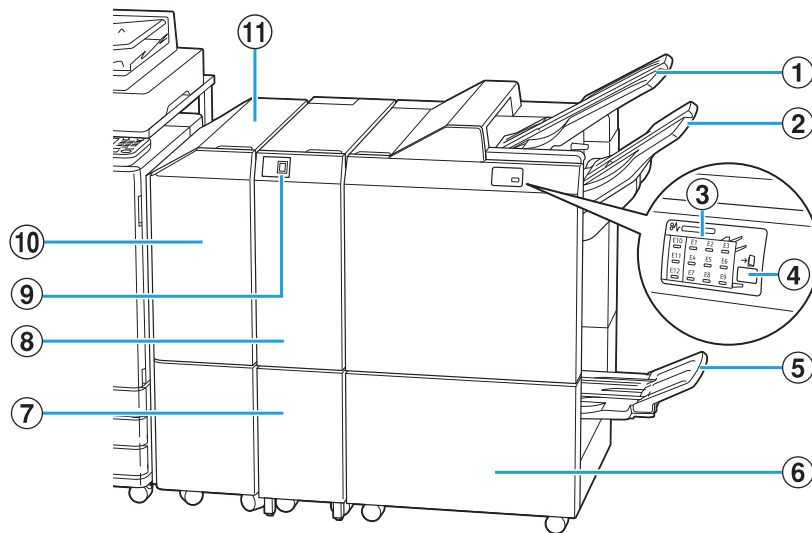

① Top Tray

When using the punching function, printouts will be output here.

② Stacking Tray

When using the staple, offset output, or punching function, printouts will be output here.

③ Paper Jam Indication LED

The location of the paper jam lights up.

④ Eject Button *

Press the eject button to move the printouts in the booklet tray to the position where you can easily retrieve them.

⑤ Booklet Tray *

Booklets and bi-folded printouts will be output here.

⑥ Right Cover

Open this cover when replacing the staple cartridge or when a paper jam has occurred.

⑦ Tri-fold Output Tray *

Tri-folded printouts will be output here.

⑧ Folder Unit *

Outer tri-fold, inner tri-fold, and Z-fold functions are available.

⑨ Tri-fold Output Tray Button *

Press this button to remove tri-folded printouts. The tri-fold tray will open towards the front.

⑩ Transfer Cover

If a paper jam occurs, open this cover and remove the jammed sheet.

⑪ Transfer Unit

Transfer paper from the printer to the multifunction finisher.

- As seen from the back

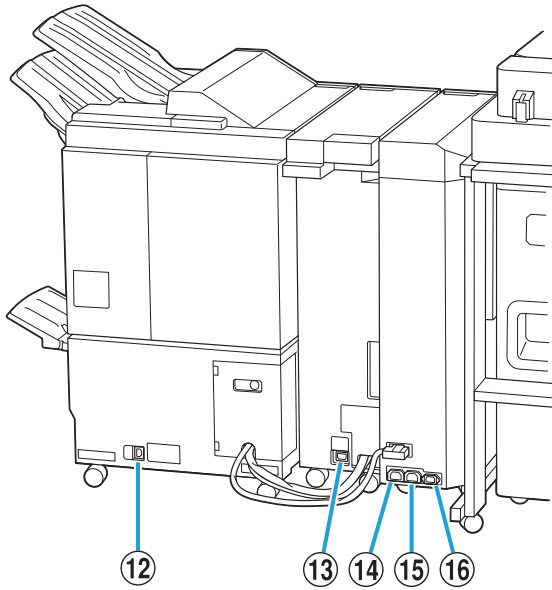

- ⑫ Multifunction Finisher Socket
Use to connect the multifunction finisher power cord.
- ⑬ Folder Unit Socket*
Use to connect the folder unit power cord.
- ⑭ Multifunction Finisher Power Distribution Socket
Use to connect the multifunction finisher power cord.
- ⑮ Folder Unit Power Distribution Socket
Use to connect the folder unit power cord.
- ⑯ Transfer Unit Socket
Use to connect the transfer unit power cord.

* Not equipped depending on the multifunction finisher you use

Caution Label

For safety use, the caution label below is adhered to the multifunction finisher. When operating or maintaining the multifunction finisher, read the instructions on the caution label for safe use. Do not remove or dirty the label. If the label is not stuck on the multifunction finisher, is peeling off, or is unreadable, contact your dealer or authorized service representative.

■ Location of the Caution Label

The location of the caution label (warning) is shown below.

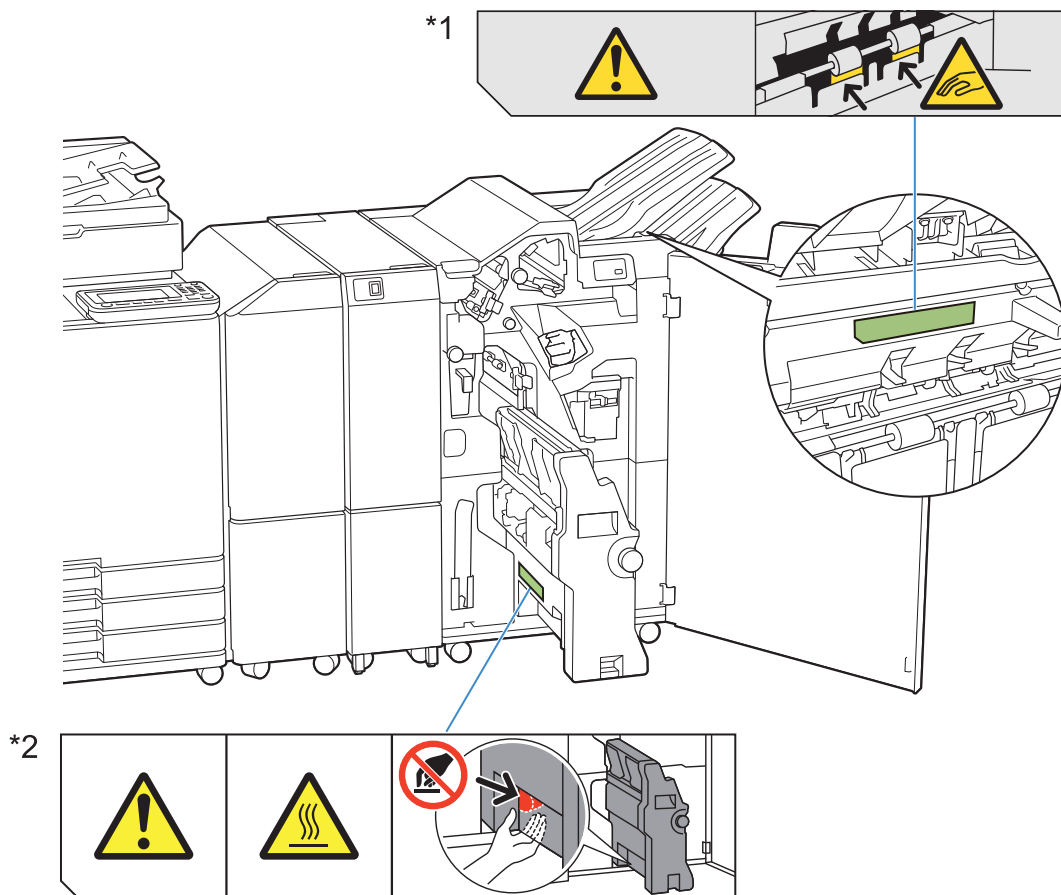

- The high temperature caution labels are also inside the multifunction finisher and the folder unit.

■ Label Details

- *1 Your fingers may become caught while the multifunction finisher moves or when you remove printouts from the stacking tray.
- *2 The location of the label may be high temperature. Contact may result in burn.

List of Settings

You can do the following when the multifunction finisher is connected.

Printer Driver

Setting item	Use this item to:	See
[Finishing] Tab		
Staple	Specify the stapling position.	p.206
Punch	Specify the punch position.	p.208
Fold	Specify the fold of the printing paper.	p.208
Booklet Binding	Specify the binding method.	p.210
Offset Output	Stack sets of printed documents slightly apart from one another when printing multiple copies.	p.212
Output Tray	Select the output tray for printouts.	p.212
Output Tray Relay	Switch the output tray automatically when the output tray becomes full.	p.212
[Advanced] Tab		
Program	Specify the number of copies by group (such as corporate division or class).	p.125
Offset Output (Program)	Stack sets of printed documents slightly apart from one another to create separation.	p.212



- When [Staple] or [Punch] is grayed out in the [Finishing] tab, make sure that [Printer Configuration] on the [Environment] tab has been configured correctly. (p.128 "Printer Configuration")

Copy Mode

Setting item	Use this item to:	See
Booklet	Configure the page assignment and folding when creating a booklet.	p.68
Binding ([Booklet])	Fold the paper in half and bind in the center with a staple.	p.213
Separating Books ([Booklet])	Specify whether to bind a bundle of volumes either flat or in the center.	p.213
Center Margin ([Booklet])	Specify a margin in the center of the folded portion.	p.213
Program	Specify the number of copies by group (such as corporate division or class).	p.74
Offset Output ([Program])	Stack sets of printed documents slightly apart from one another to create separation.	p.214
Separation	Specify where to insert slip sheets between printouts.	p.77
Offset Output ([Separation])	Stack sets of printed documents slightly apart from one another to create separation.	p.214
Staple / Punch	Specify the stapling/punch position.	p.214
Fold	Specify how the paper is folded as well as the direction thereof.	p.215
Output Tray	Select the output tray for printouts.	p.217
Face Up/Down	Specify whether to stack the pages face up or face down in the stacker.	p.217
Output Tray Relay	Switch the output tray automatically when the output tray becomes full.	p.217



- The punch settings are displayed when you are using the optional punch unit.

Printer Driver Settings

Staple

Specify the stapling position.



- When [Staple] is configured, make sure to configure [Binding Edge].
- When [Staple] is configured, [Sort] is set to [Collated]. (p.109 "Sort")
- When [Booklet] is configured, [Staple] is [OFF]. (p.114 "Booklet")
- When [Booklet Binding] is configured, [Staple] is [OFF]. (p.210 "Booklet Binding")
- The [Staple], [Poster], and [Output Tray Relay] functions cannot be used at the same time. (p.115 "Poster", p.212 "Output Tray Relay")
- The orientation of the paper varies depending on the binding edge. See "Staple Function and Loading Orientation of the Paper" (p.207).

If you select [Left] or [Right] for [Binding Edge], select from the following options:

[OFF], [1 Staple], [2 Staples]

If you select [Top] for [Binding Edge], select from the following options:

[OFF], [Left 1 Staple], [Right 1 Staple], [2 Staples]

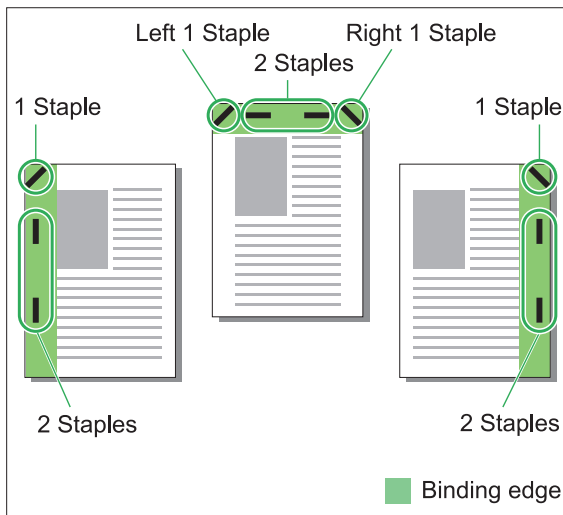

<Types of paper that can be stapled>

- Paper size: A3, B4, A4, A4-LEF, B5, B5-LEF, A5-LEF, Ledger, Legal, Letter, Letter-LEF, Foolscap, 8K, 16K, 16K-LEF, Custom size

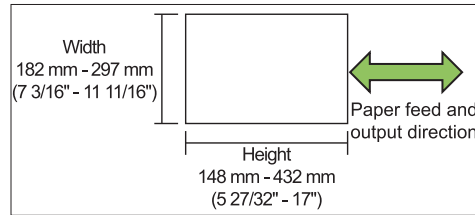

- Paper weight: 52 g/m² - 210 g/m² (14-lb bond - 56-lb bond)

<Number of sheets that can be stapled>

- When using standard size paper
 A4, A4-LEF, B5, B5-LEF, A5-LEF, Letter, Letter-LEF, 16K, 16K-LEF: 2 to 100 sheets
 Sizes other than the above (A3, B4, Ledger, Legal, Foolscap, 8K): 2 to 65 sheets
- When using custom size paper
 Paper length exceeds 297 mm (11 11/16"): 2 to 65 sheets
 Paper width and length exceed 216 mm (8 1/2"): 2 to 65 sheets
 Non-standard size paper other than the above: 2 to 100 sheets



- When a job exceeding the maximum number of sheets that can be stapled is printed, the printouts will be output without being stapled.

Staple Function and Loading Orientation of the Paper

The orientation in which to load the paper in the paper tray (standard tray) and the stapling position are as listed below.

Orientation: Portrait



Orientation: Landscape



Face Up/Down: Face up



Face Up/Down: Face down

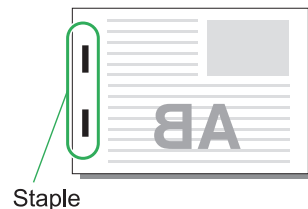

Binding Edge	Staple position					
	1 Staple		2 Staples			
Left						
Right						
Top	Left 1 Staple		Right 1 Staple		2 Staples	
Paper transfer			 Paper feed and output direction			



- When paper of the corresponding size is not loaded in the tray, a message will appear. Follow the displayed instructions and load the tray with paper.
- For [1 Staple], depending on the paper size and loaded direction, the angle of the staple may differ from the above drawing or the printing image shown on the printer driver screen.
- When multiple different original sizes are used in the original, the machine automatically rotates the image to suit the [Binding Edge] setting.

Punch

Specify the number of holes to punch.



- When [Booklet] is configured, [Punch] is [OFF]. (p.114 "Booklet")
- When [Booklet Binding] is configured, [Punch] is [OFF]. (p.210 "Booklet Binding")

[OFF], [2 Holes], [3 Holes], [4 Holes]



- The number of holes that can be punched varies depending on the connected finisher.

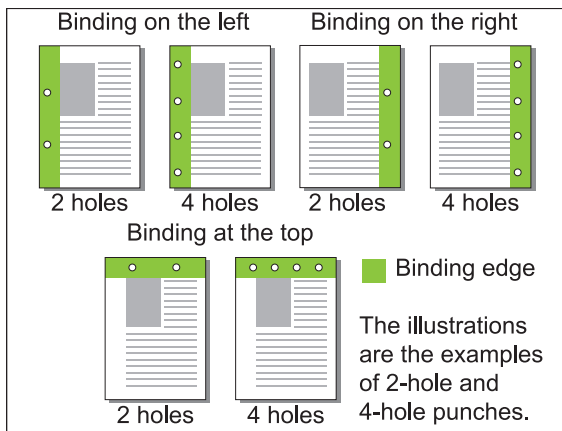

<Types of Paper that can be punched>

- Paper size:
 2 holes: A3, B4, A4, A4-LEF, B5-LEF, Ledger, Legal, Letter, Letter-LEF, Foolscap, 8K, 16K-LEF
 3 holes: A3, B4, A4-LEF, B5-LEF, Ledger, Letter-LEF, 8K, 16K-LEF
 4 holes: A3, A4-LEF, Ledger, Letter-LEF, 8K, 16K-LEF
- Paper weight: 52 g/m² - 210 g/m² (14-lb bond - 56-lb bond)

Fold

Select the folding type such as bi-fold or Z-fold.



- [Fold] cannot be used together with [Booklet], [Poster], [Multi-part Paper Printing], or [Booklet Binding]. (p.114 "Booklet", p.115 "Poster", p.127 "Multi-part Paper Printing", p.210 "Booklet Binding")

- [Bi-fold], [Inner Tri-fold], and [Outer Tri-fold] cannot be used together with [Mixed Size Original], [Binding Edge], [Slip Sheet], [Add Cover], [Program], [Blank Page Detection], [Staple], [Punch], [Offset Output], and [Output Tray Relay]. (p.109 "Mixed Size Original", p.118 "Binding Edge", p.119 "Slip Sheet", p.119 "Add Cover", p.125 "Program", p.126 "Blank Page Detection", p.180 "Staple", p.208 "Punch", p.212 "Offset Output", p.212 "Output Tray Relay")

<Types of Paper that can be folded>

- Paper size:
 Bi-fold: A3, B4, A4, B5, Ledger, Legal, Letter, Foolscap, 8K, 16K, Custom size
 Inner Tri-fold, Outer Tri-fold: A4, Letter
 Z-fold: A3, B4, Ledger, 8K

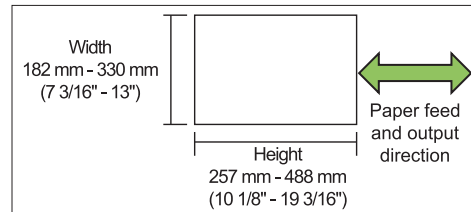

- You cannot fold the paper in two, which has a width longer than its height.

- Paper weight: 60 g/m² - 90 g/m² (16-lb bond - 24-lb bond)

[OFF]

The paper will not be folded.

[Bi-fold]

The paper will be folded in two, one sheet at a time.

[Inner Tri-fold]

The paper will be folded inwards in three, one sheet at a time.

[Outer Tri-fold]

The paper will be folded outwards in three, one sheet at a time.

[Z-fold]

The paper will be folded in the shape of a Z, one sheet at a time.

When used together with [Mixed Size Original], Z-folded paper and non-Z-folded paper are output with mixed.

Select the type of fold and click [Details] to display the [Fold] dialog box. Configure the folding direction and binding edge.

■ Fold Direction

When [Bi-fold], [Inner Tri-fold], or [Outer Tri-fold] is selected, configure whether the printed surface is to be facing inward or outward.



- When using duplex printing, the first page will be regarded as the printed surface.

[Print Inside]

The paper will be folded so that the printed surface is on the inside.

[Print Outside]

The paper will be folded so that the printed surface is on the outside.

Bi-fold

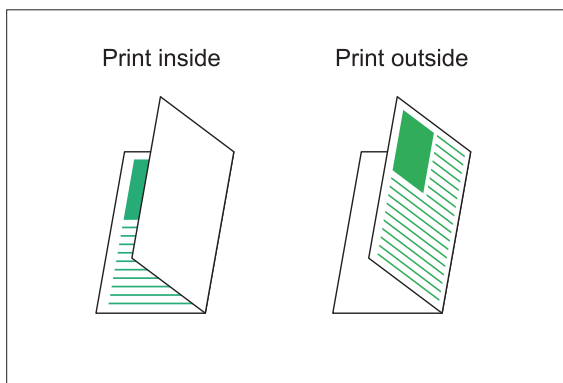

Inner tri-fold

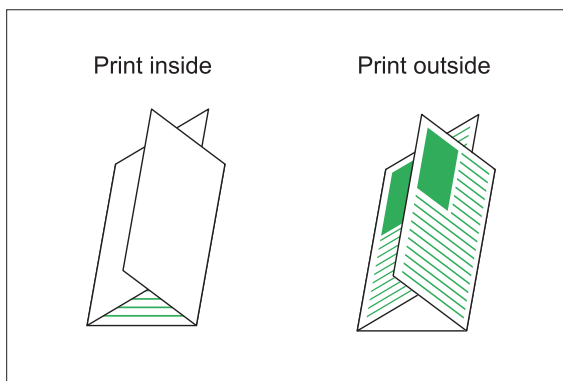

Outer tri-fold

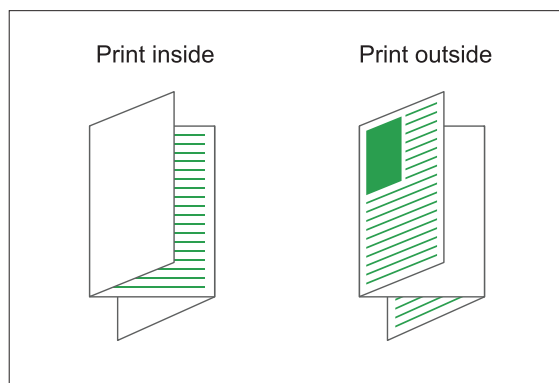

■ Binding Edge

When [Z-fold] is selected, configure the binding edge of the paper.

[Bind Left/Top]

The right half of the paper will be folded in the shape of a Z.

[Bind Right/Bottom]

The left half of the paper will be folded in the shape of a Z.

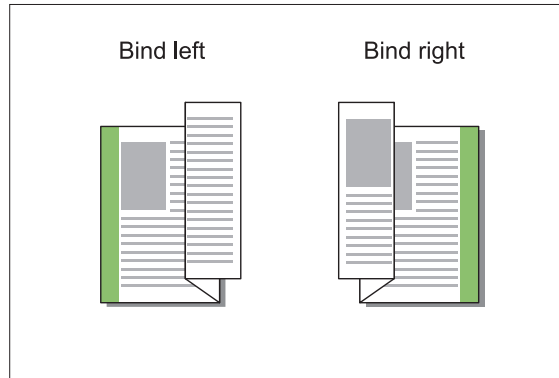

- When [Mixed Size Original] is configured, it is possible to select [Z-fold] only for [Fold]. In this case, the combinations of original sizes that can be mixed are "A4-LEF and A3", "B5-LEF and B4", and "Letter-LEF and Ledger". (p.109 "Mixed Size Original")
- When used together with [Mixed Size Original], for [Orientation], select the orientation of the original that is larger. (When the A4 original is vertical and the A3 original is horizontal, select [Landscape]) (p.109 "Original Size", p.109 "Mixed Size Original")
- For [Paper Size], specify the size of the paper subject to the Z-fold. (p.110 "Paper Size")

- When using this function with duplex printing, duplex printing is only applied when the size of the front and back of the document is the same. (If the size is not the same, the back of the page is left blank.) (p.108 "Duplex/Simplex")
- When used together with [Mixed Size Original], you can specify [Staple], [Punch], and [Offset Output]. (p.109 "Mixed Size Original", p.206 "Staple", p.208 "Punch", p.212 "Offset Output")
- When used together with [Add Cover], the added cover will be the size after the Z-fold. (p.119 "Add Cover")

Booklet Binding

Perform duplex printing of a series of multiple pages and create a booklet by bi-folding the paper. The booklet can also be bound in the center with a staple.



- When [Booklet Binding] is configured, [Sort] is set to [Collated]. (p.109 "Sort")
- [Booklet Binding] cannot be used together with [Mixed Size Original], [Combine], [Image Repeat], [Binding Edge], [Slip Sheet], [Program], [Blank Page Detection], [Multi-part Paper Printing], [Staple], [Punch], [Fold], [Offset Output], and [Output Tray Relay]. (p.109 "Mixed Size Original", p.113 "Combine", p.114 "Image Repeat", p.118 "Binding Edge", p.119 "Slip Sheet", p.125 "Program", p.126 "Blank Page Detection", p.127 "Multi-part Paper Printing", p.180 "Staple", p.208 "Punch", p.208 "Fold", p.212 "Offset Output", p.212 "Output Tray Relay")

<Types of paper that can be used to create booklets>

- A3, B4, A4, B5, Ledger, Legal, Letter, Foolscap, 8K, 16K, Custom size

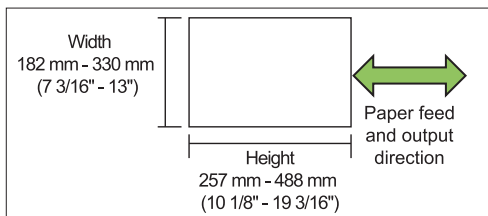

- You cannot use the paper which has a width longer than its height.

[OFF]

Booklet binding will not be configured.

[Fold]

The printing paper will be folded in two.

[Fold + Staple]

The printing paper is folded in half and bound in the center with a staple.

Select the booklet binding method and click [Details] to display the [Booklet Binding] dialog box.

Configure separating books, center binding, and separate cover printing.

■ Separating Books

When you have selected [Fold] or [Fold + Staple], some restrictions apply to the number of sheets you can fold.

[Fold] creates a separate booklet every 5 sheets (20 pages), and [Fold + Staple], a booklet every 20 sheets (80 pages).

When the number of pages exceeds these numbers of sheets, one fold is made every number of sheets indicated above and the sheets are output (creating a separate booklet).

The layout order is different depending on whether middle binding or side binding is performed for the separate stacks. Therefore, select [OFF] or [ON].



- [Separating Books] and [Add Cover] cannot be used at the same time. (p.119 "Add Cover")

[OFF]

Data is imposed to create a book by opening, layering, and then binding the sheets (in the center).

When [OFF] has been selected, the sheets are not stapled even if [Fold + Staple] is selected.

[ON]

Data is imposed to create a book by folding, layering, and then binding the sheets (on the side).

Example: 60 pages, set to [Fold], separating books [OFF]

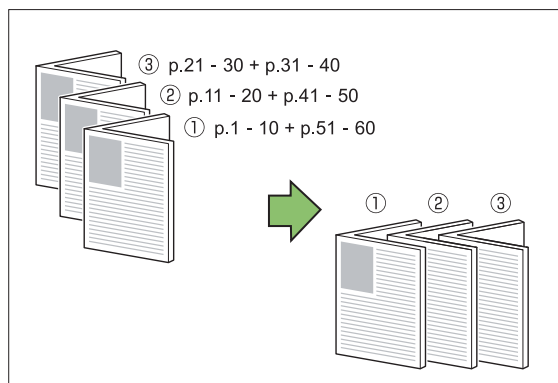

Example: 60 pages, set to [Fold], separating books [ON]

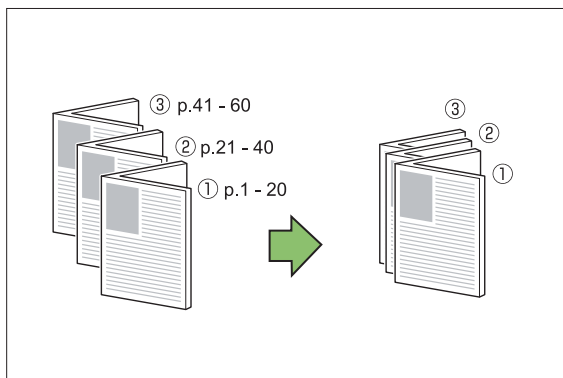

■ Center Margin

Enter a value for [Width].
Select the [Auto Reduction] check box to automatically reduce the printed image to fit the paper in cases where the margin width does not allow for the original-scale printed image to fit into the paper.

■ Booklet Cover

Print only the cover page (the first two pages and the last two pages of the original) separately. This setting is convenient for printing the cover and body using different types of paper.



• [Booklet Cover] and [Add Cover] cannot be used at the same time. (p.119 "Add Cover")

[OFF]

Cover separated printing is not configured.

[Print Cover Only]

The cover page only is printed.

[Print Except Cover]

The pages other than the cover are printed as a booklet.

[Store Except Cover to Waiting List]

When printing the body pages after printing the cover, place a check in [Store Except Cover to Waiting List] to instruct printing from the operation panel on the machine. In this case, specify the feed tray that is loaded with printed cover paper.

[Cover Sheet Tray]

[Standard Tray], [Feed Tray 1], [Feed Tray 2], [Feed Tray 3]



• When using the optional high capacity feeder, [High Capacity Feeder] is displayed in place of [Standard Tray].

The example describes a situation where the cover page only is printed separately and later combined with the body pages for booklet binding.

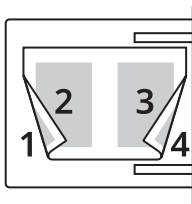
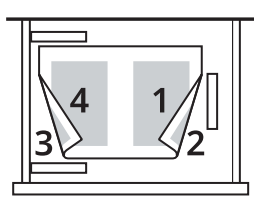
- 1 Click [Print Cover Only] under [Booklet Cover].
- 2 Select the [Store Except Cover to Waiting List] check box.
- 3 Select [Cover Sheet Tray].
- 4 Click [OK].
Only the cover page is printed and main body data will be listed in a waiting job.
- 5 Load the printed cover onto the tray of the machine configured with [Cover Sheet Tray].
The following describes the orientation of printed cover paper loaded in each tray:
For the standard tray:  For the feed tray: 
- 6 Touch [Print] on the [Home1] screen.
- 7 Select the job.
- 8 Press the [Start] key.
The body pages are printed and combined with the cover for booklet binding.

Offset Output

Stack sets of printed documents slightly apart from one another when printing multiple copies.



- When [Program] is configured, [Offset Output] is [OFF]. (p.125 "Program")
- This setting is not available for paper sizes that cannot be output to the stacking tray.
- When [Mixed Size Original] is configured, [Offset Output] is [OFF]. (p.109 "Mixed Size Original")
- When [Bi-fold], [Inner Tri-fold], or [Outer Tri-fold] of [Fold] is configured, [Offset Output] is [OFF]. (p.208 "Fold")
- When [Booklet Binding] is configured, [Offset Output] is [OFF]. (p.210 "Booklet Binding")
- Normally when 2-step offset and staple are used together, this will act as a 3-step offset.

2-step Offset

Without staple (multifunction finisher, face down finisher)

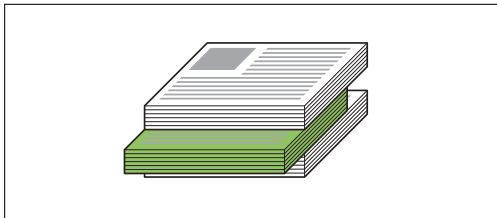

3-step Offset

With staple (multifunction finisher)

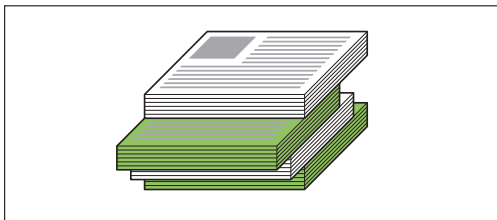

[OFF]

Offset output is not performed.

[Between Sorts]

Sets of printed documents specified in [Sort] are stacked slightly apart from one another.

[Between Jobs]

Finished print jobs are stacked slightly apart from one another.

Output Tray

Specify the output tray for printouts.

When [Auto] is specified, printouts are output to the appropriate tray automatically based on the configured functions. To output printouts to the multifunction finisher, select [Top Tray] / [Stacking Tray].

Click [Details] to display the [Output Tray] dialog box. Specify whether to stack the pages face up or face down in the stacker.

[Face Up], [Face Down]



- When [Staple], [Punch], [Fold], [Booklet Binding], or [Offset Output] is configured, the output trays that can be selected with [Output Tray] will differ depending on the configured details. (p.206 "Staple", p.208 "Punch", p.208 "Fold", p.210 "Booklet Binding", p.212 "Offset Output")

Output Tray Relay

The output tray switches automatically when the tray is full.



- When [Output Tray Relay] is configured, [Sort] is set to [Uncollated]. (p.109 "Sort")
- [Output Tray Relay] cannot be used together with [Add Cover], [Staple], [Bi-fold], [Inner Tri-fold] and [Outer Tri-fold] of [Fold], or [Booklet Binding]. (p.119 "Add Cover", p.180 "Staple", p.208 "Fold", p.210 "Booklet Binding")

Offset Output (Program)

In addition to the "Program" (p.125) function for printouts, you can stack sets of printed documents slightly apart from one another to create separation.

[OFF]

Offset output is not performed.

[Between Sets]

Each set of printed documents is stacked slightly apart from one another.

[Between Groups]

Groups of printed documents are stacked slightly apart from one another.

Copy Mode Settings

Binding ([Booklet])

In addition to the "Booklet" (p.68) function for copying, you can configure the fold and staple when finishing printouts in the form of a booklet.



- When [Binding] is configured, [Sort] is set to [Collated]. (p.64 "Sort")
- [Binding] cannot be used together with [Program], [Separation], [Output Tray], [Face Up/Down], or [Output Tray Relay]. (p.74 "Program", p.77 "Separation", p.217 "Output Tray", p.217 "Face Up/Down", p.217 "Output Tray Relay")

[OFF]

Binding will not be configured.

[Fold + Staple]

The paper is folded in half and stapled (bound in the center).

[Fold]

The paper will be folded in two.

Separating Books ([Booklet])

When you have selected [Fold] or [Fold + Staple] for [Binding], some restrictions apply to the number of sheets you can fold.

[Fold] creates a separate booklet every 5 sheets (20 pages), and [Fold + Staple], a booklet every 20 sheets (80 pages).

When the number of pages exceeds these numbers of sheets, one fold is made every number of sheets indicated above and the sheets are output (creating a separate booklet).

The layout order is different depending on whether middle binding or side binding is performed for the separate stacks. Therefore, select [OFF] or [ON].

[OFF]

Data is imposed to create a book by opening, layering, and then binding the sheets (in the center).

When [OFF] has been selected, the sheets are not stapled even if [Fold + Staple] is selected.

[ON]

Data is imposed to create a book by folding, layering, and then binding the sheets (on the side).

Example: 60 pages, set to [Fold], separating books [OFF]

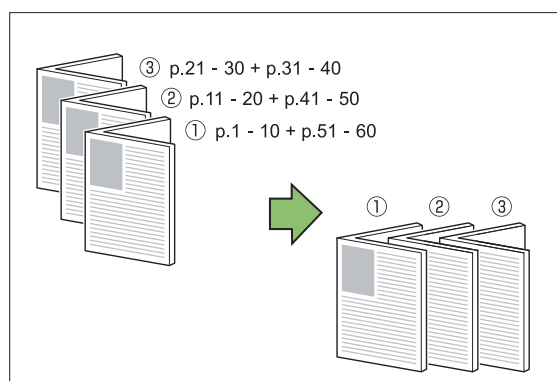

Example: 60 pages, set to [Fold], separating books [ON]

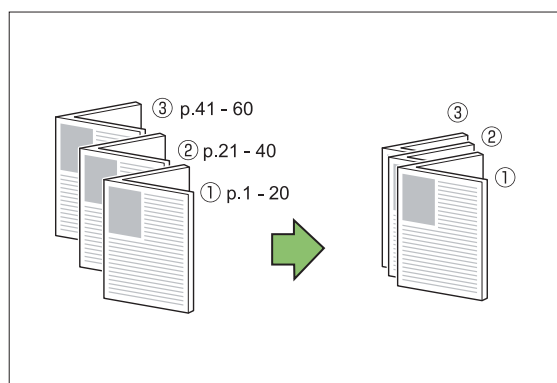

Center Margin ([Booklet])

Set the center margin to the center of folded sections to prevent the folded sections from hiding when the sheets are folded in two.

When [Center Margin] is configured, you can configure [Auto Reduction]. If the center margin you have specified causes the printed image not to fit on the sheet, set automatic reduction to [ON].



- The center margin can be configured only when [Layout Order] is set to other than [OFF] with [Booklet] for copying and [Fold + Staple] or [Fold] is selected for [Binding].

Offset Output ([Program])

In addition to the "Program" (p.74) function for copying, you can stack sets of printed documents slightly apart from one another to create separation.

[OFF]

Offset output is not performed.

[Between Sets]

Each set of printed documents is stacked slightly apart from one another.

[Between Groups]

Groups of printed documents are stacked slightly apart from one another.

Offset Output ([Separation])

In addition to the "Separation" (p.77) function for copying, you can stack sets of printed documents slightly apart from one another to create separation.



- [Offset Output] cannot be used together with [Mixed Size Original], [Binding] of [Booklet], or [Bi-fold], [Inner Tri-fold], and [Outer Tri-fold] of [Fold]. (p.65 "Mixed Size Original", p.213 "Binding ([Booklet])", p.215 "Fold")

[OFF]

Offset output is not performed.

[Between Sorts]

Each sorted set is stacked slightly apart from one another.

[After a Job]

Each print job is stacked slightly apart from one another.

<Paper that can be offset>

- A3, B4, A4, A4-LEF, A5-LEF, B5-LEF, Ledger, Legal, Letter, Letter-LEF, Foolscap, Specified Size (203 mm × 148 mm - 297 mm × 488 mm (8" × 5 27/32" - 11 11/16" × 19 3/16"))

- 1 Touch [Separation].
- 2 Select the offset output setting.
- 3 Touch [OK].

Staple / Punch

Staple or punch holes at the specified position.



- [Staple / Punch] cannot be used together with [Booklet], [Page Border], [Bi-fold], or [Inner Tri-fold] and [Outer Tri-fold] of [Fold]. (p.68 "Booklet", p.71 "Page Border", p.215 "Fold")
- The [Staple] and [Output Tray Relay] functions cannot be used at the same time. (p.217 "Output Tray Relay")

<Types of paper that can be stapled>

- Paper size: A3, B4, A4, A4-LEF, B5, B5-LEF, A5-LEF, Ledger, Legal, Letter, Letter-LEF, Foolscap, 8K, 16K, 16K-LEF, Custom size

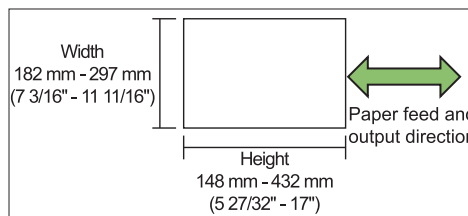

- Paper weight: 52 g/m² - 210 g/m² (14-lb bond - 56-lb bond)

<Number of sheets that can be stapled>

- When using standard size paper
A4, A4-LEF, B5, B5-LEF, A5-LEF, Letter, Letter-LEF, 16K, 16K-LEF: 2 to 100 sheets
Sizes other than the above (A3, B4, Ledger, Legal, Foolscap, 8K): 2 to 65 sheets
- When using custom size paper
Paper length exceeds 297 mm (11 11/16"): 2 to 65 sheets
Paper width and length exceed 216 mm (8 1/2"): 2 to 65 sheets
Custom size paper other than the above: 2 to 100 sheets



- When a job exceeding the maximum number of sheets that can be stapled is printed, the printouts will be output without being stapled.

<Types of Paper that can be punched>

- Paper size:
2 holes: A3, B4, A4, A4-LEF, B5-LEF, Ledger, Legal, Letter, Letter-LEF, Foolscap, 8K, 16K-LEF
3 holes: A3, B4, A4-LEF, B5-LEF, Ledger, Letter-LEF, 8K, 16K-LEF
4 holes: A3, A4-LEF, Ledger, Letter-LEF, 8K, 16K-LEF
- Paper weight: 52 g/m² - 210 g/m² (14-lb bond - 56-lb bond)

■ Original Orientation

[Top Side Up]

Select this option when loading originals in an orientation from which they can be read normally.

[Top Side Left]

Select this option when loading originals so that the top of the original is aligned with the left edge.

■ Binding Edge

Select the binding edge of the paper.

Left, Right, Top

■ Staple

Specify the stapling position.

- If you select the left or the right for [Binding Edge], select from the following options:
[OFF], 1 staple, 2 staples
- If you select the top for [Binding Edge], select from the following options:
[OFF], left 1 staple, right 1 staple, 2 staples



- The left 1 staple and the right 1 staple are displayed only when the top is selected for [Binding Edge].

1 Touch [Staple / Punch].

2 Select [Binding Edge].

3 Configure [Staple].

4 Touch [OK].

■ Punch

Specify the number of holes to punch.

[OFF], 2 holes, 3 holes, 4 holes

1 Touch [Staple / Punch].

2 Select [Binding Edge].

3 Configure [Punch].

4 Touch [OK].

■ Binding Margin

You can specify the binding margin so that staples or punches are not in the printing area.

1 Touch [Binding Margin] on the [Staple / Punch] screen.

The [Binding Margin] screen is displayed.

2 Specify the binding margin.

- Select [Binding Edge].
- Use [↓], [↑], or the numeric keys to enter the width.
- If part of the printing area is missing due to the binding margin setting, set [Auto Reduction] to [ON].

3 Touch [OK].

Fold

Configure the folding such as bi-fold or Z-fold.



- When [Mixed Size Z-fold] for [Fold] is set to [ON], this can be used together with [Staple / Punch]. (p.214 "Staple / Punch")
- [Fold] cannot be used together with [Mixed Size Original], [Booklet], [Page Border], or [Face Up/Down]. (p.65 "Mixed Size Original", p.68 "Booklet", p.71 "Page Border", p.217 "Face Up/Down")
- [Bi-fold], [Inner Tri-fold], and [Outer Tri-fold] cannot be used together with [Program], [Add Cover], [Separation], [Binding Margin], [Staple / Punch], and [Output Tray Relay]. (p.74 "Program", p.77 "Add Cover", p.77 "Separation", p.78 "Binding Margin", p.214 "Staple / Punch", p.217 "Output Tray Relay")
- [Z-fold] cannot be used together with [Slip Sheet] of [Separation] and [Punch]. (p.77 "Separation", p.214 "Staple / Punch")
- [Mixed Size Z-fold] cannot be used together with [Reproduction Size], [Book Shadow Erasure], [Page Split], [Combine], [Image Repeat], or [Overlay]. (p.61 "Reproduction Size", p.66 "Book Shadow Erasure", p.67 "Page Split", p.68 "Combine", p.68 "Image Repeat", p.73 "Overlay")

- Paper size:
Bi-fold: A3, B4, A4, B5, Ledger, Legal, Letter, Foolscap, 8K, 16K, Custom size
Inner Tri-fold, Outer Tri-fold: A4, Letter
Z-fold: A3, B4, Ledger, 8K

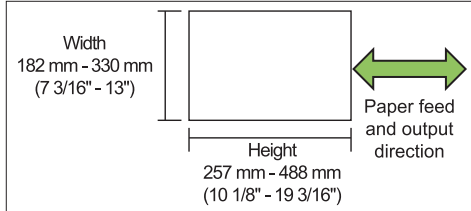

• You cannot fold the paper in two, which has a width longer than its height.

- Paper weight: 60 g/m² - 90 g/m² (16-lb bond - 24-lb bond)

[OFF]

The paper will not be folded.

[Bi-fold]

The paper will be folded in two, one sheet at a time.

[Inner Tri-fold]

The paper will be folded inwards in three, one sheet at a time.

[Outer Tri-fold]

The paper will be folded outwards in three, one sheet at a time.

[Z-fold]

The paper will be folded in the shape of a Z, one sheet at a time.

[Fold Direction]

Configure whether the printed surface is to be folded to face inward or outward.

Fold	Fold Direction
[Bi-fold]	
[Inner Tri-fold]	
[Outer Tri-fold]	

[Binding Edge]

Specify the binding edge of the paper.

Fold	Binding edge
[Z-fold]	

[Mixed Size Z-fold]

When set to [ON], of the originals in two types of sizes, the larger paper is processed with a Z-fold while the smaller paper is printed without being folded.

The combinations of original sizes that can be mixed with Z-folds are "A4-LEF and A3", "B5-LEF and B4", and "Letter-LEF and Ledger".

[Auto Image Rotation]

This rotates the image 90 degrees automatically when the orientations of the original and paper do not match, even if the paper size loaded in the tray matches the size of the loaded original. Normally, this setting is set to [ON].

■ **[Bi-fold], [Inner Tri-fold], or [Outer Tri-fold]**

- 1 Touch [Fold].
- 2 Select the folding type.
- 3 Select [Fold Direction].
- 4 Touch [OK].

■ **[Z-fold]**

- 1 Touch [Fold].
- 2 Touch [Z-fold].
- 3 Select [Binding Edge].
- 4 When the original sizes are mixed, select [Mixed Size Z-fold].

5 Touch [OK].

After the confirmation screen is displayed, touch [OK] and set [Auto Image Rotation] to [OFF].

Output Tray

Select the output tray for printouts.



- The tray details displayed on the [Output Tray] screen vary depending on the optional equipment that is connected.

[Auto]

The appropriate tray is selected automatically.

[①Face Down Tray], [②Top Tray], [③Stacking Tray]

Select the output tray.

1 Touch [Output Tray].

2 Select the output tray.

3 Touch [OK].

Face Up/Down

Specify whether to stack the pages face up or face down in the stacker.

[Face Up], [Face Down]



- [Face Up/Down] cannot be used together with [Binding] or [Fold] of [Booklet]. (p.213 "Binding ([Booklet])", p.215 "Fold")

Output Tray Relay

The output tray switches automatically when the tray that is being used becomes full.

1 Touch [Output Tray Relay].

2 Touch [ON].

3 Touch [OK].



- [Output Tray Relay] cannot be used together with [Booklet], [Overlay], [Add Cover], [Staple], [Bi-fold], or [Inner Tri-fold] and [Outer Tri-fold] of [Fold]. (p.68 "Booklet", p.73 "Overlay", p.77 "Add Cover", p.214 "Staple / Punch", p.215 "Fold")
- When [Output Tray Relay] is configured, [Sort] is set to [Uncollated]. (p.64 "Sort")

PS Kit

When the PS kit is installed, it becomes possible to print combinations of variable data such as forms and databases for slips, and also print DTP data using PostScript fonts.

This section describes basic printer driver operations, as well as how to use various functions.



- Log in as a user with administrator privilege (Windows), or as a root user (Mac OS or Linux).
- Close all active applications.
- PS Kit FG10 is not supported in some regions.

Operating Environment

The system requirements for activating the PostScript 3 printer driver are described in the table below.

Memory	1 GB or more
CPU	Windows or Linux: Intel® or fully compatible CPU Mac OS: Intel CPU
Hard disk	2 GB or more free space (Sufficient to operate the OS)
Display	1024 × 768 or greater resolution

Installing to Windows



- To update the printer driver, uninstall the current printer driver before updating. (p.219 "Uninstalling From Windows")

1 Load the included DVD-ROM in the computer's DVD-ROM drive.

The installation wizard automatically starts up. If the installation wizard does not start up, double-click the "Install.exe" file on the DVD-ROM.

2 Select the desired language in the pull-down menu and click [OK].

3 Click [Next].

4 Follow the on-screen instructions to configure the settings.

5 When the message for printing a test page is displayed, click [Yes].

6 Confirm that the test page is printed correctly and click [OK].



- Pressing [Show "ReadMe" text.] displays the "Readme" screen that includes precautions for using the machine. Be sure to read this information.
- When a message that prompts you to update the status of the machine appears, click [OK] and set the printer configuration under the [Environment] tab after installation. When you added an optional equipment to the machine, you also need to set the printer configuration. When optional equipment is connected, first configure the settings to use certain functions. The unavailable functions are grayed out. (p.127 "[Environment] Tab")

7 Click [Finish].

If the printer driver is installed over the existing one, the computer restarts.



- If you do not want to restart the computer now, remove the check mark from the [Restart now] check box before clicking [Finish].

8 Remove the DVD-ROM from the computer.



- Keep the DVD-ROM in a safe place for future reference.

Uninstalling From Windows

■ For Windows 10 and Windows Server 2019

Click [Start] - [RISO ComColor-GL PS] - [Uninstaller]. Follow the displayed instructions for uninstallation.

After the printer driver has been uninstalled, restart the computer.

■ For Windows 8.1, Windows Server 2012, and Windows Server 2012 R2

Open the [Apps] screen and click [RISO ComColor-GL PS] - [Uninstaller]. Follow the displayed instructions for uninstallation.

After the printer driver has been uninstalled, restart the computer.

Installing to Mac OS

1 Load the included DVD-ROM in the computer's DVD-ROM drive.

Double-click the installation package file on the DVD-ROM.

2 Click [Continue].

3 Click [Install].

4 Follow the on-screen instructions to configure the settings.

On the authentication screen, enter values for [Name] and [Password], and click [Install Software].



• Contact your administrator for [Name] and [Password] information.

5 Click [Close].

6 Remove the DVD-ROM from the computer.



• Keep the DVD-ROM in a safe place for future reference.

7 Add a printer.

1) Open the Mac OS startup volume, and open [Applications] - [System Preferences].

2) Click [Printers & Scanners] or [Print & Scan].

3) Click the [+] button.

8 Configure the queue and click [Add].

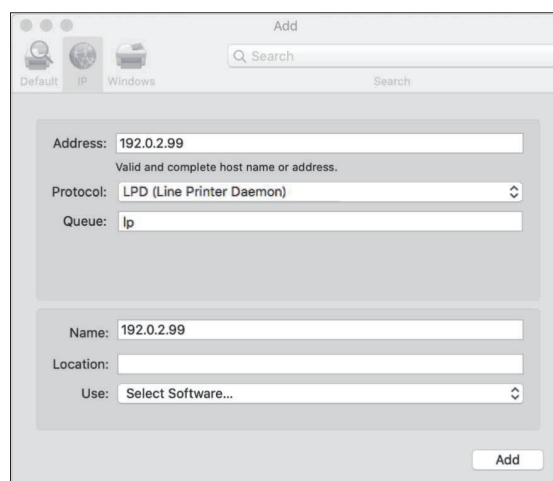

On the [Add] screen, click [IP] and enter the IP address and queue.

[Queue]: Enter "lp" in lowercase characters for the queue.

[Use]: Click [Select Software] to open the [Printer Software] screen. Select the printer driver you installed.

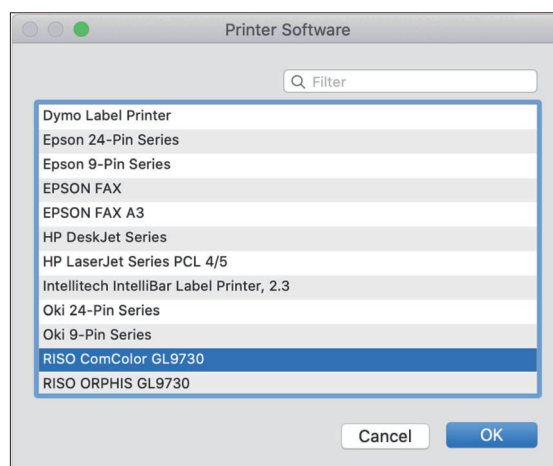



- When the screen for confirming the connection status of optional equipment is displayed after clicking [Add], select the connected optional equipment and click [OK].

Setting the Printer Configuration

When you use the printer for the first time or added an option to the machine, you need to set the printer configuration.

1 On the [Printers & Scanners] or [Print & Scan] screen, select ComColor GL (printer name), then click [Open Print Queue].

2 Click [Settings].

The print que screen of the printer is displayed. You can check the printer information by clicking each tab.

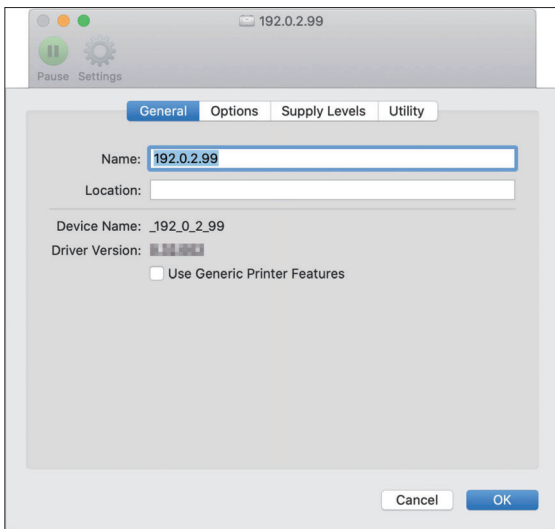

[General] tab: You can check the device name or the printer driver version.

[Options] tab: You can check and change the option setting acquired from the printer.

[Supply Levels] tab: You can check the condition of supplies such as paper or ink.

[Utility] tab: You can set the SNMP community name, Wake On LAN, shared folder, form, barcode area definition, and color profile.

3 Click [Open Printer Utility] on the [Utility] tab.

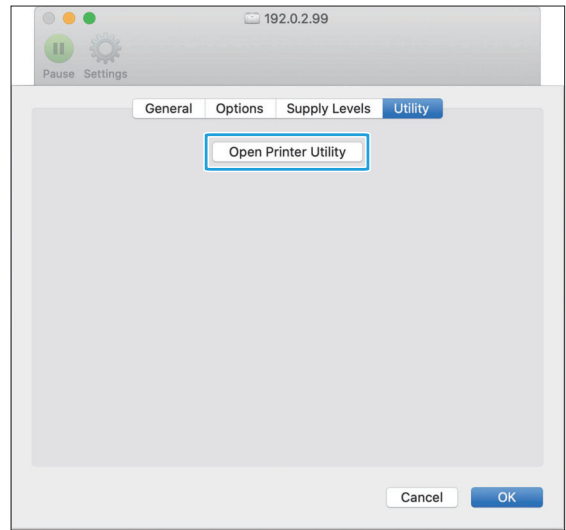

The [Utility] screen is displayed.

4 Specify the SNMP community name.

Specify the community name required for obtaining the machine's information from the computers with SNMP communication.

Select the [SNMP Community Name] check box and enter a community name for SNMP communication with 1 to 32 characters.

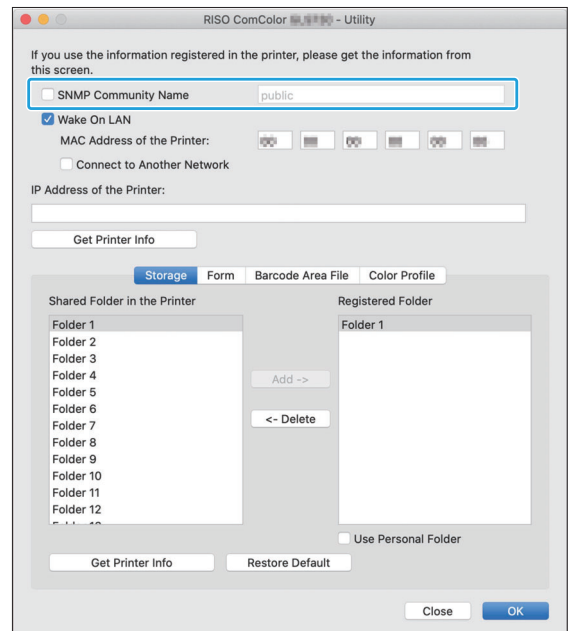

- If a check is not placed in [SNMP Community Name], the community name for SNMP communication will be set to "public".

- Alphanumeric characters (uppercase/lowercase) and the following symbols can be entered in the text box for [SNMP Community Name]:
., / : ; @ [\] ^ _
- It will not be possible to obtain information from the machine if the SNMP community names are different between the machine and the printer driver. If you have made changes to the SNMP community name with the machine, you must make sure to also apply the change to the printer driver.

5 Specify the Wake On LAN setting.

To enable the Wake On LAN setting used for waking up the machine via LAN, set the machine MAC address on the printer driver.



- If you try to print in a network environment where Wake On LAN communication is not enabled, the printer does not wake up automatically.

1) Select the [Wake On LAN] check box.

When the printer's and computer's network segments are different, you also need to select the [Connect to Another Network] check box. Normally, leave this check box unselected.

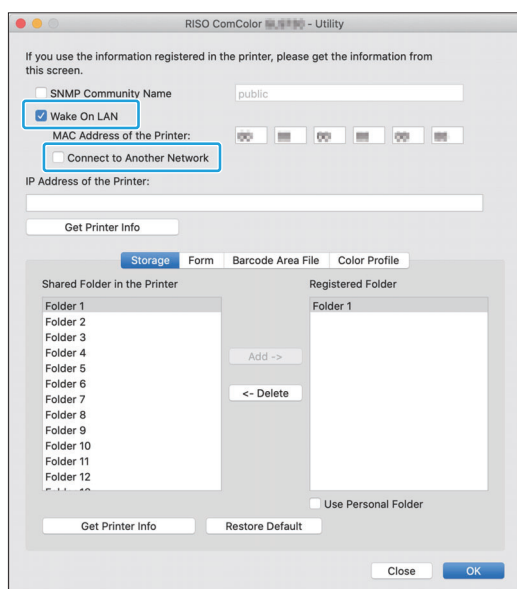

2) Enter the IP address of the machine in [IP Address of the Printer] and click [Get Printer Info].

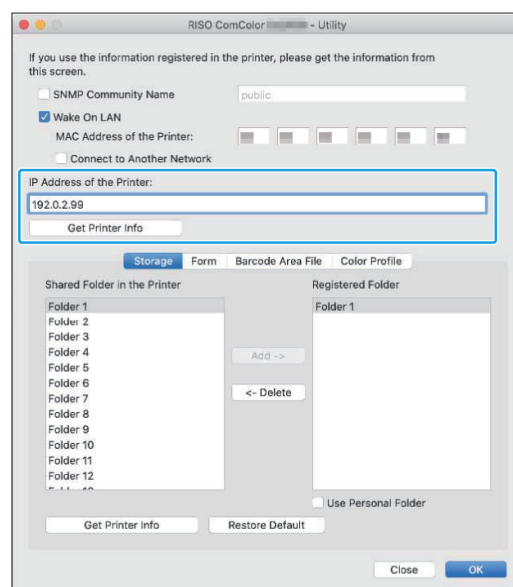

The MAC address of the machine is displayed in [MAC Address of the Printer].



- You can also enter the MAC address manually in the text box for [MAC Address of the Printer].

6 Register the folder.

You can register the folder (shared folder or personal folder) to save print data on the printer driver.

The folder registered here will be displayed in [Output] on the [Basic] tab.

1) Click [Get Printer Info].

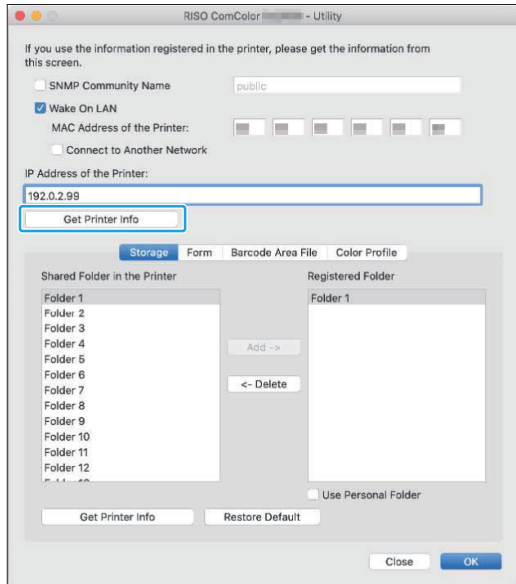

The information of shared folders registered in the printer is displayed in [Shared Folder in the Printer].

2) Select a folder to add to [Registered Folder] and click [Add ->].

3) Set the personal folder.

Select [Use Personal Folder] when you have a personal folder.

4) Click [OK].

7 Get the information of [Form], [Barcode Area File], or [Color Profile] as required.

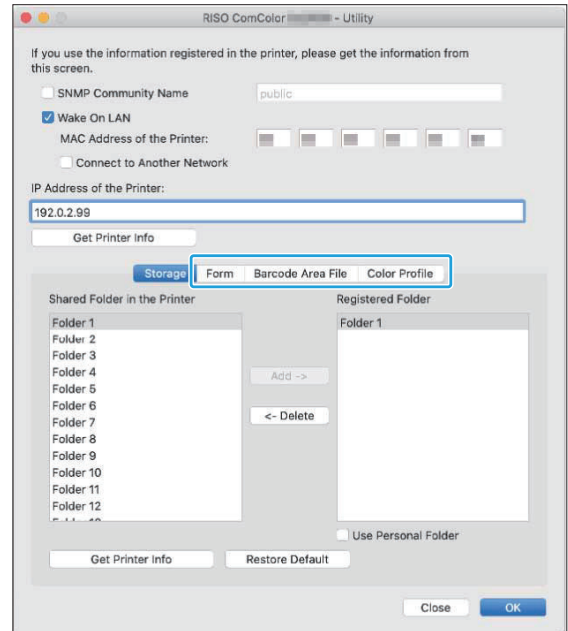

Clicking [Get Printer Info] on each tab acquires the information from the printer.

Uninstalling From Mac OS

1 Open the Mac OS startup volume, and open [Applications] - [System Preferences].

2 Click [Printers & Scanners] or [Print & Scan].

3 Select the printer you want to delete, and click the [-] button.



- Delete the following folder and file from the Mac OS startup volume as needed:
 - The [RISO] folder in [Library] - [Printers].
 - "RSGL ****.ppd" file within [Library] - [Printers] - [PPDs] - [Contents] - [Resources]

Installing to Linux

Printing can be performed from Linux if the PPD file included on the DVD-ROM is registered to CUPS for Linux.



- Before installing, make sure that all of the necessary Linux system settings are properly configured.
- The procedure for installing to Linux may vary depending on your Linux environment. The standard installation procedure is described here.

- 1 Open the screen for registering a printer.**
- 2 Configure the printer.**
Follow the on-screen instructions to select the protocol (LPD, LPR, etc.), and enter the IP address of the printer.
- 3 Configure the queue.**
Enter "lp" in lowercase characters for the queue.
- 4 Select the driver.**
Load the included DVD-ROM in the computer's DVD-ROM drive, and select the PPD file.
- 5 Follow the on-screen instructions to configure the settings.**
Enter the printer name and other required information.
- 6 Remove the DVD-ROM from the computer.**



- Keep the DVD-ROM in a safe place for future reference.

Uninstalling the PPD File

- 1 Open the screen for registering a printer.**
- 2 Select the printer icon and delete it.**

How to Print

Printing from a Windows Computer

For more information, see "Overview of Print Operations" (p.100) in "Printing".

Printing from a Mac

This section describes the basic procedure for printing from a Mac.



- The screens displayed may vary depending on the operating system and applications used, as well as the optional equipment connected.
- Some setting items may not be displayed, depending on how the administrator has configured the settings. Contact your administrator for details.

- 1 Open the print screen in the application on the computer.**
Select [Print] in the [File] menu.
- 2 Select the printer.**
- 3 Click [▼].**
- 4 Click [Show Details].**
Change the settings.
- 5 Click [Print] to perform printing.**

Printer Driver Settings

This section describes the items that can be configured when the PS kit is installed, using the [Printing Preferences] screen in Windows as an example.

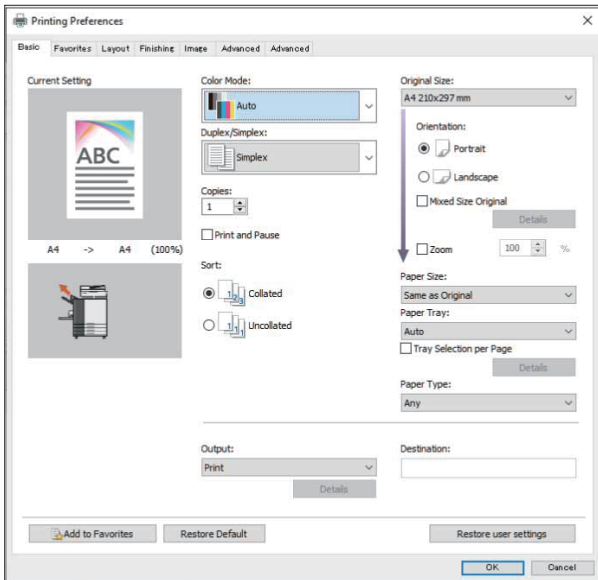

- When optional equipment is connected, first configure the settings in [Printer Configuration] under the [Environment] tab to use certain functions.
- When printing from a Mac OS, use the standard OS settings for [Copies], [Original Size], and [Orientation].

[Basic] Tab

For more information on each setting item, see "[Basic] Tab" (p.108) in "Printing".

Output

Specify whether to print the data sent from a computer, or save it in a folder on this machine. Form data can also be registered to the machine.

[Print]

Prints the data.

[Print & Storage]

Saves the original data in a folder on the machine and prints it.

[Storage]

Saves the original data in a folder on the machine. In addition, creates a PRN file to use in the Barcode Area Definition Software.

[Form]

Registers forms.

For more information, see "Form Overlay" (p.228) in the [Advanced] tab.

Tray Selection per Page

You can specify the tray to use for each page. When the check box is selected, you can specify which tray to print from, for each page.

[Standard Tray]

Specify the pages that are printed from the standard tray.

[Feed Tray 1]

Specify the pages that are printed from feed tray 1.

[Feed Tray 2]

Specify the pages that are printed from feed tray 2.

[Feed Tray 3]

Specify the pages that are printed from feed tray 3.

[Additional Tray]

Specify the pages that are printed from the additional tray.

[Repetition]

When you select the check box and enter the number of pages (cycle), the page settings of each tray will be repeated for each cycle when printing. You can save the trouble of specifying the pages in detail for each tray when originals have a large number of pages.



- Use commas to separate the specified page numbers (1,2,3, etc.), or specify a range of pages (such as 1-10).
- If no tray is specified for a particular page, it is printed from the tray specified in the [Paper Tray] setting.
- When a tray is specified for a page, image processing is performed on the page based on the paper settings (paper type) for the specified tray.
- When using the optional high capacity feeder, [High Capacity Feeder] is displayed in place of [Standard Tray].
- [Additional Tray] is displayed when using the optional additional tray.
- The highest page number of the values specified for each tray is displayed as the default value in [Repetition]. You cannot specify a value lower than the default value.
- If you enter an invalid number in the text box for [Repetition] and click [OK], the color of the text box will turn red, and the range of valid numbers will be displayed in red. Enter the valid number.

Setting Example

Specifying a tray for each page when printing a 26-page document

Setting values for each tray

- [Standard Tray]: 1,5
- [Feed Tray 1]: 2
- [Feed Tray 2]: 3
- [Feed Tray 3]: Blank

Tray used for printing

- When [Repetition] is set to off.

Tray used	Page number
Standard tray	1, 5
Feed tray 1	2
Feed tray 2	3
Tray specified in [Paper Tray] (p.110)	4, 6-26

- When [Repetition] is set to "10".

Tray used	Page number
Standard tray	1, 5, 11, 15, 21, 25
Feed tray 1	2, 12, 22
Feed tray 2	3, 13, 23
Tray specified in [Paper Tray] (p.110)	4, 6-10, 14, 16-20, 24, 26



- [Tray Selection per Page] cannot be used together with [Mixed Size Original], [Combine], [Image Repeat], [Booklet], [Rotation], [Add Cover], or [Multi-part Paper Printing]. (p.109 "Mixed Size Original", p.113 "Combine", p.114 "Image Repeat", p.114 "Booklet", p.117 "Rotation", p.119 "Add Cover", p.127 "Multi-part Paper Printing")
- If you are using the optional multifunction finisher, [Tray Selection per Page] cannot be used together with [Fold] and [Booklet Binding]. (p.208 "Fold", p.210 "Booklet Binding")

[Favorites] Tab

For more information on each setting item, see "[Favorites] Tab" (p.112) in "Printing".

[Layout] Tab

For more information on each setting item, see "[Layout] Tab" (p.113) in "Printing".



- The [Watermark] setting is not available with the PostScript printer driver.

Image Shift

Adjust the printing position of images.



- You can adjust the printing position a maximum of ± 254 mm (10") up, down, left, or right, in increments of 0.1 mm (0.004").
- When performing duplex printing, the front and back sides can be adjusted separately.

Select the [Image Shift] check box and click [Details] to display the [Image Shift] dialog box. Enter a value in the box for the direction that you want to adjust.

[Front Side], [Back Side]

Enter a value for [Horizontal] or [Vertical].

[Reset]

Resets the entered value to 0 on the front or back side separately.

Preview

You can preview the adjusted image position on the front or back side separately.

[Finishing] Tab

For more information on each setting item, see "[Finishing] tab" (p.118) in "Printing".



- For more information on the following function when using the face down finisher, see "Face Down Finisher" (p.178): [Staple], [Offset Output]
- For more information on the following function when using the stacking tray, see "Stacking Tray (Auto-control Stacking Tray / Wide Stacking Tray)" (p.191): [Output Tray], [Output Tray Relay]
- For more information on the following function when using the high capacity stacker, see "High Capacity Stacker" (p.195): [Offset Output], [Output Tray], [Output Tray Relay]

- For more information on the following function when using the multifunction finisher, see "Multifunction Finisher" (p.202): [Staple], [Punch], [Fold], [Offset Output], [Output Tray], [Output Tray Relay]
- [Mail Making] is not available with the PostScript printer driver when using the Wrapping Envelope Finisher.
- [Perfect Binding] is not available with the PostScript printer driver when using the Perfect Binder.

Booklet Binding

Perform duplex printing of a series of multiple pages and create a booklet by bi-folding the paper. The booklet can also be bound in the center with a staple. For more information on booklet binding, see "Booklet Binding" (p.210) in "Optional Equipment".

Select the booklet binding method and click [Details] to display the [Booklet Binding] dialog box.

■ Separating Books

For the booklet binding, printouts are output upon being separated per booklet based on a certain number of pages per volume. The imposition will differ depending on the settings.

[OFF]

The pages will be imposed so that the pages are in order when the booklet is bound in the center. When the data contains a large number of pages, the booklets will be output as multiple volumes. The pages will be imposed so that when these volumes are opened and stacked on top of each other, they can be bound (center binding) to form a single booklet.

[Auto]

The pages will be imposed so that when all volumes that are output are stacked in their folded state, the pages will be in the correct order. The volumes will be output per 5 sheets when [Booklet Binding] is set to [Fold] while they will be output per 20 sheets when this is set to [Fold + Staple].

[1 Sheet], [2 Sheets], [3 Sheets], [4 Sheets], [5 Sheets], [6 Sheets], [7 Sheets], [8 Sheets], [9 Sheets], [10 Sheets], [11 Sheets], [12 Sheets], [13 Sheets], [14 Sheets], [15 Sheets], [16 Sheets], [17 Sheets], [18 Sheets], [19 Sheets], [20 Sheets]

When [Booklet Binding] is set to [OFF], you can configure per how many sheets the volumes will be separated. Printouts are output upon being separated per booklet based on the configured number of pages.

The pages per volume can be set in the range of being output per 1 to 5 sheets when [Booklet Binding] is set to [Fold] or a range of being output per 1 to 20 sheets when this is set to [Fold + Staple].



- In the factory default state, multiple volumes will be output when the number of pages exceeds 5 sheets when [Booklet Binding] is set to [Fold] or 20 sheets when this is set to [Fold + Staple].
- The staples will not be inserted when multiple volumes are being output.
- When [Separating Books] is set to other than [OFF], [Booklet Cover] and [Add Cover] cannot be used.

[Image] Tab

For more information on each setting item, see "[Image] Tab" (p.120) in "Printing".

Gamma Correction

Adjust the brightness, contrast, and gamma value of cyan, magenta, yellow, black, and gray.

Select the [Gamma Correction] check box and click [Details] to display the [Gamma Correction] dialog box.

[Brightness]

The smaller the value, the brighter (more whitish) the color. The larger the value, the darker (more blackish) the color.

Specify a value between -2 and +2.

[Contrast]

Adjusts the ratio of brightness to darkness. The smaller the value, the lower the contrast. The larger the value, the higher the contrast.

Specify a value between -2 and +2.

[Cyan], [Magenta], [Yellow], [Black], [Gray]

Corrects the gamma value of each color.

The smaller the value, the lighter the color. The larger the value, the deeper the color. When you set the value to 1.00, the gamma value is not corrected and the color does not change. Specify a value between 0.01 and 3.00.



- Make your color adjustments based on the advice of the administrator.

Color Profile

Use a color profile to perform color management. When the check box is selected, [Details] is displayed.



- [Color Profile], [Original Type], [Print Density], and [Processing Speed Priority] of [Image Quality] cannot be used at the same time. (p.120 "Original Type", p.121 "Print Density", p.121 "Image Quality")

Output Profile

You can select [Auto] or any output profile that has been added.



- When [Auto] is selected, the output profile is automatically configured based on the paper type and resolution settings.

Rendering Intent

Use a color conversion method to perform color replacement when different colors are expressed by combinations of numerical values.

Select one of four different color conversion methods to perform color replacement.

[Perceptual]

Preserves the visual relationship between colors, so that colors that appear natural to the human eye.

- This method is useful when the image data includes many out-of-gamut colors that cannot be printed, and is most suitable for photographic images.

[Saturation]

Produces vivid colors in the image.

- This method is most suitable for graphics such as charts and graphs, in which bright saturated colors are important.

[Relative Colorimetric]

Compares the extreme highlights of the source color space to that of the destination color space, and converts all colors accordingly. Out-of-gamut colors are converted to the closest reproducible color in the destination color space.

- This method preserves more of the original colors in an image than [Perceptual].

[Absolute Colorimetric]

Preserves the colors that are inside the gamut, and clips those that are outside the gamut.

- This method is particularly useful for previewing how paper color affects printed colors.

■ Max Drops

You can manually set the maximum number of drops for the ink.



- When [Max Drops] is set to [Auto], the number of drops is automatically configured based on the paper type. Normally, use [Auto].

[Advanced] Tab

For more information on each setting item, see "[Advanced] Tab" (p.124) in "Printing".



- The [Program] and [Blank Page Detection] settings are not available with the PostScript printer driver.
- [Color Profile] is not displayed on the [Version] screen of the PostScript printer driver.

Form Overlay

You can select a form that has been registered to the machine, and overlay it on the output data for printing.

Select the [Form Overlay] check box and click [Details] to display the [Form Overlay] dialog box. Configure the settings for overlaying the form.

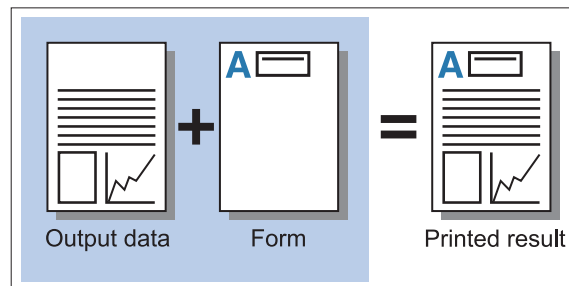

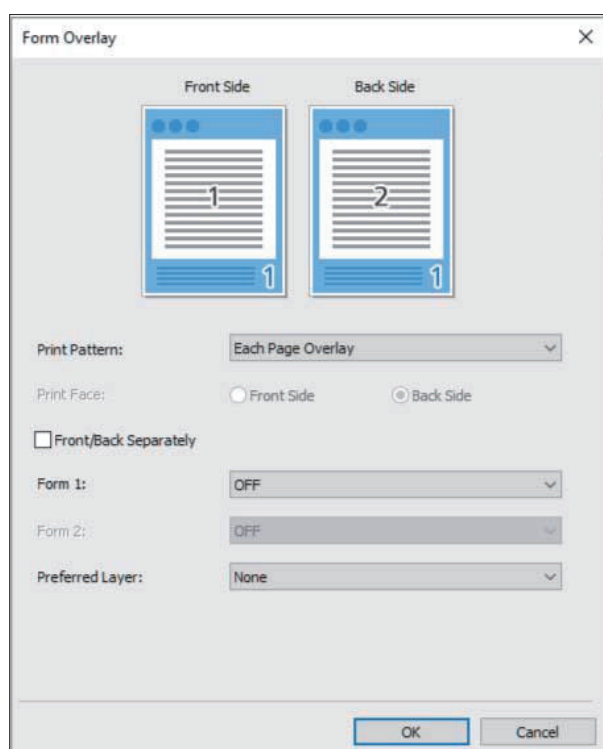
**[Print Pattern]**

Specify whether to print the form on the same side as the output data.

[Print Face]

When [Alternating Overlay (Long Edge)]/[Alternating Overlay (Short Edge)] or [Each Page + Alternating Overlay (Long Edge)]/[Each Page + Alternating Overlay (Short Edge)] is selected, specify whether to print the form on the front or back.

[Front/Back Separately]

When performing duplex printing, you can specify separate forms for the front and back.



- This setting is available if [Each Page Overlay] or [Each Page + Alternating Overlay (Long Edge)]/[Each Page + Alternating Overlay (Short Edge)] is selected in [Print Pattern].

[Form 1]

Select the form to print on the front or both sides of the output data.

[Form 2]

Select the form to print on the back side of the output data.

[Preferred Layer]

When [Each Page Overlay], [Each Page + Alternating Overlay (Long Edge)], or [Each Page + Alternating Overlay (Short Edge)] is selected, specify whether to assign priority to the form or the output data.



- Before using these settings, you must first create the form data on a computer and register it in [Output] in the [Basic] tab. (p.224 "Output")
- When printing the overlaid form comprised of 5 colors (cyan, magenta, yellow, gray, and black) in color, select the setting items other than [Processing Speed Priority] for [Image Quality]. If [Processing Speed Priority] is selected, gray of the form cannot be reproduced in the printed result. (p.121 "Image Quality")
- Forms are printed based on the output data orientation, paper size, and image quality settings.
- Output data with overlaid forms cannot be saved (registered).
- You cannot use [Form Overlay] with the [Mixed Size Original], [Combine], [Image Repeat], [Booklet], or [Booklet Binding] function. (p.109 "Mixed Size Original", p.113 "Combine", p.114 "Image Repeat", p.114 "Booklet", p.210 "Booklet Binding")

■ Print Pattern

Select a form that is saved on the machine, and select which side of the paper to print it on.

[Each Page Overlay]

Prints the form on the same side as the output data.

When performing duplex printing, select [Front/Back Separately]. When the [Front/Back Separately] check box is selected, you can select forms for [Form 1] and [Form 2] from the form list.

[Each Page Overlay] with [Front/Back Separately] disabled

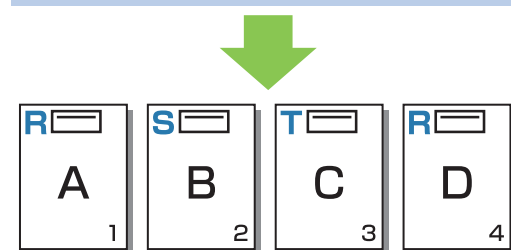
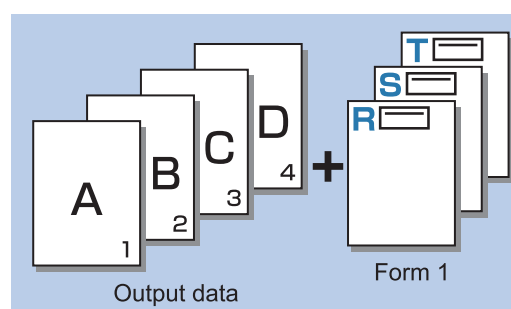

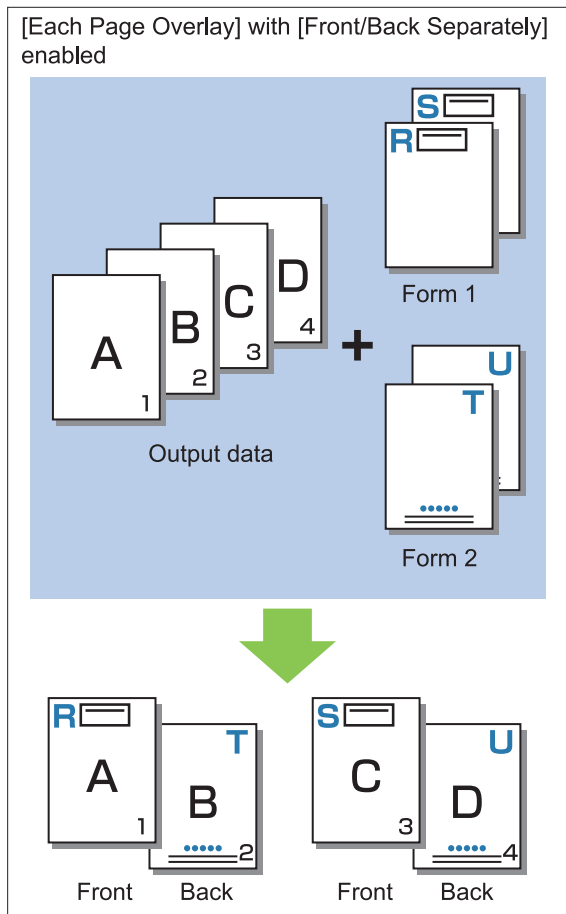

[Alternating Overlay (Long Edge)]/[Alternating Overlay (Short Edge)]

Prints the form and output data on different sides. The form data is printed on the side specified in [Print Face]. The output data is printed as variable data on the other side.

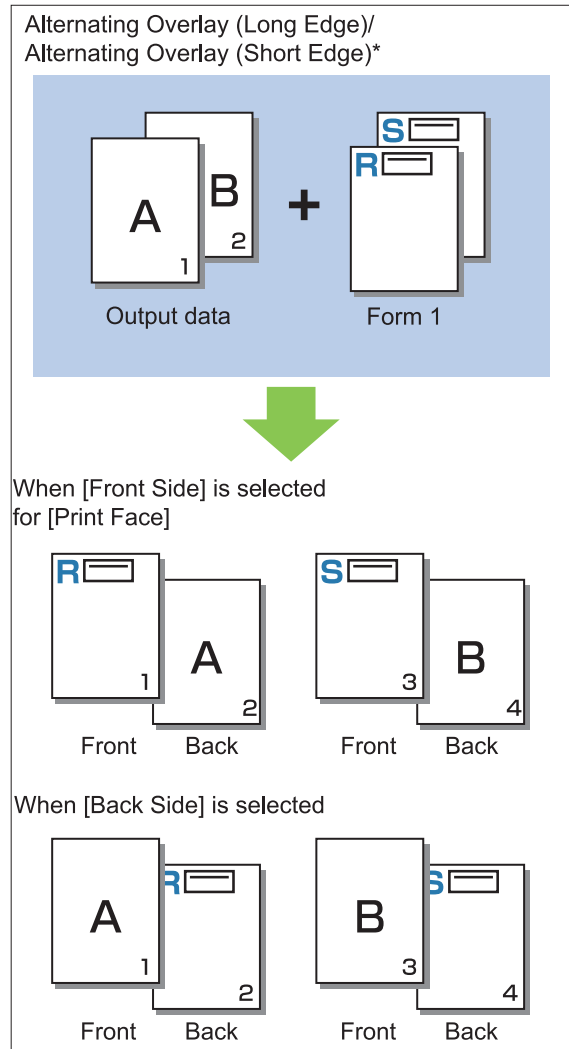

* The illustration is an example of long edge binding.

[Each Page + Alternating Overlay (Long Edge)]/[Each Page + Alternating Overlay (Short Edge)]

The form is overlaid on the output data on one side, and a different form is printed on the other side.

You can specify the separate forms in [Form 1] and [Form 2].

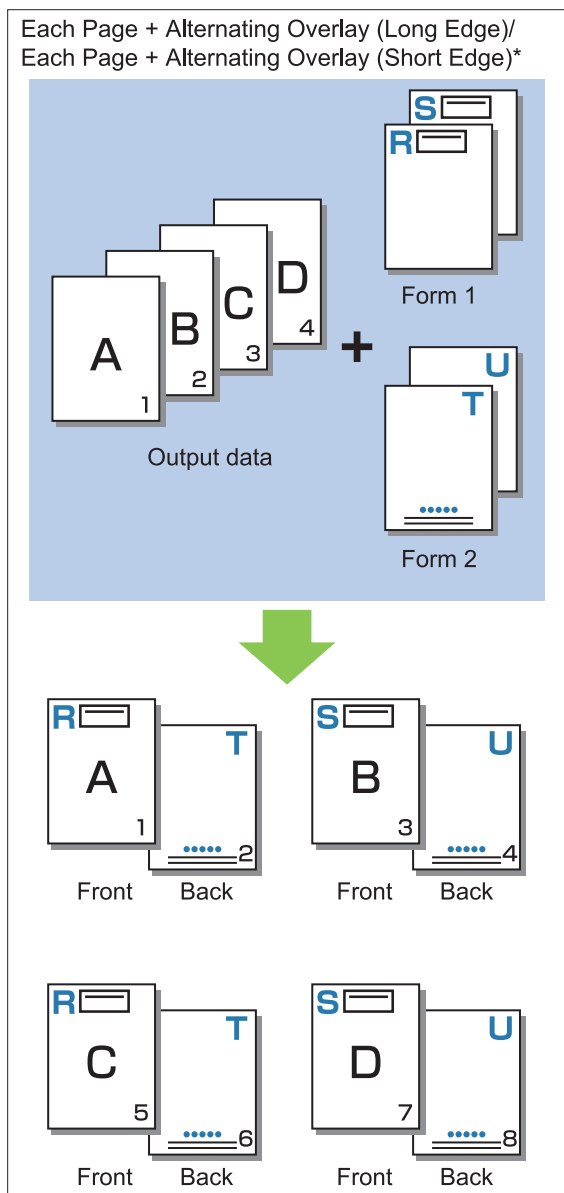

* The illustration is an example of long edge binding.



- This function is not available when [Mixed Size Original] is configured.
- This function is not available when [Combine] is configured.

Print Face

When [Alternating Overlay (Long Edge)]/[Alternating Overlay (Short Edge)] or [Each Page + Alternating Overlay (Long Edge)]/[Each Page + Alternating Overlay (Short Edge)] is selected in [Print Pattern], specify whether to print the form data on the front or back side of the paper.

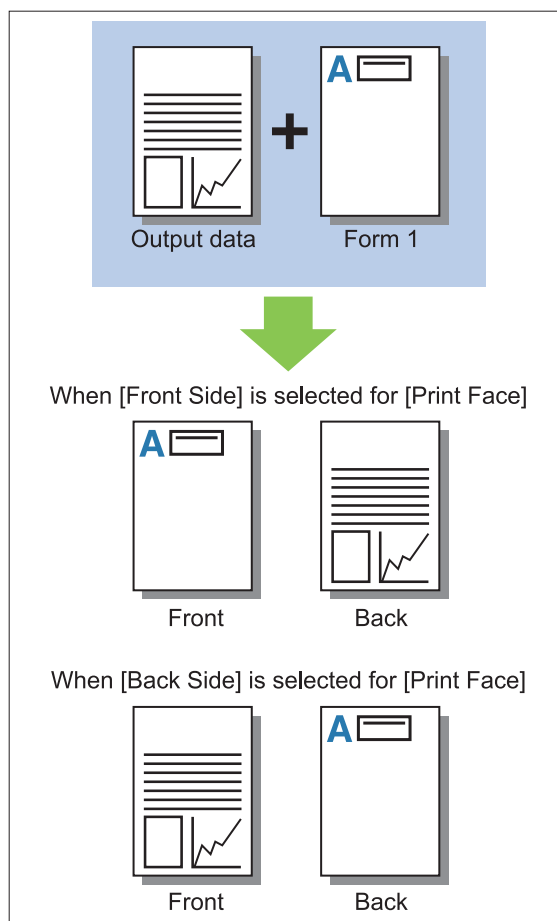

- When [Each Page + Alternating Overlay (Long Edge)]/[Each Page + Alternating Overlay (Short Edge)] is selected, specify the side on which to print only the form.

Preferred Layer

When [Each Page Overlay], [Each Page + Alternating Overlay (Long Edge)], or [Each Page + Alternating Overlay (Short Edge)] is selected for [Print Pattern], specify whether to assign priority to the form data or the output data, and overlay it on the other.

[None]

The output data and the form data are overlaid.

[Document]

Priority is given to the output data (original) layer, and it is overlaid on top of the form data.

[Form]

Priority is given to the form data layer, and it is overlaid on top of the output data.



- If the image size of the priority layer is larger than that of the non-priority layer, the image of the non-priority layer may not be printed.
- If the output data and the form data overlap on the portions having the same color, it might be difficult to distinguish the image of the assimilated portions.

Reverse Order

When the check box is selected, printouts are printed in reverse order. [Reverse Order] cannot be used together with [Booklet] or [Booklet Binding]. (p.114 "Booklet", p.210 "Booklet Binding")

[Environment] Tab

For more information on each setting item, see "[Environment] Tab" (p.127) in "Printing". [Default Paper Type of "Any"] and [External System Link] are not available with the PostScript printer driver.

RISO Console Settings

You can use the [Form Data] screen in the [Storage] menu.

[Form Data] Screen

Displays the form data that have been sent by selecting [Form] in the [Output] setting of the RISO ComColor GL PS Printer Driver. The RISO ComColor GL PS Printer Driver is available when the PS kit is installed.

[Delete]

Delete the selected form data from the list.

[Details]

You can check the settings of the selected form data. You can also change the settings.

Printable Files in the USB Flash Drive

When the PS kit is installed, you can not only use the printer driver to save data to a USB flash as a PRN file for printing, but also can save PDF files as it is to a USB flash drive and print directly with the machine.

The files that can be used are displayed on the document list screen on the machine.

■ Example of the Folder Structure in a USB flash Drive

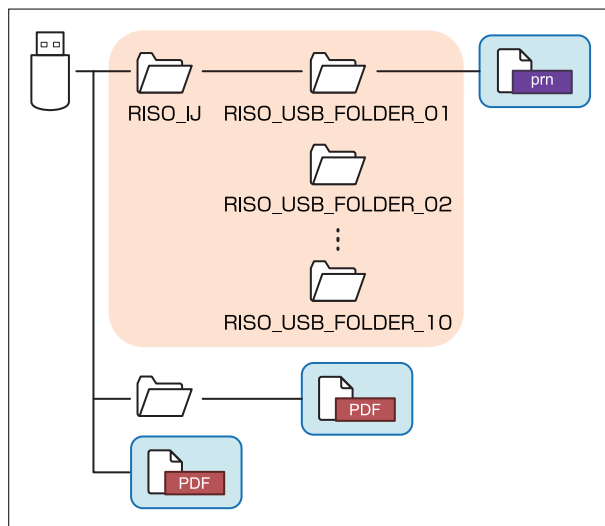

The files inside the blue rectangles in the above figure are displayed on the document list screen.



- Save PDF files directly to the USB flash drive without creating a folder, or save them to a folder that you created beforehand. If PDF files are saved in the [RISO_IJ] folder generated by the printer driver, you cannot use them with the machine.
- The following types of files saved on a USB flash drive cannot be used:
 - PDF files that are protected with a password
 - PDF files whose job data is broken
 - PDF files that are saved in the [RISO_IJ] folder
 - PRN files that are saved outside the [RISO_IJ] folder

- An original that contains high resolution images or a file with a file size that exceeds the maximum capacity of the machine
-

List of Settings in [USB] - [Load]

You can change the print settings for PDF files.

Select the folder on the [USB] - [Load] screen, and touch [Open] to display a list of the documents inside the folder. When you select a document and touch [Print Setting] in the sub menu, the setting screen is displayed. The settings that can be configured on this screen are listed below.

Setting item	Use this item to:	See
Color Mode	Select color or monochrome printing.	p.61
Reproduction Size	Specify enlargement or reduction of original images before printing, if needed. [Fit to Paper] is not available.	p.61
Paper Selection	Change the paper tray, paper type, and feed control settings according to the paper used for printing.	p.61
Duplex/Simplex	Specify the sides of the paper that are printed on.	p.108
Sort	Specify the sorting method when printing multiple copies.	p.64
Print Density	Specify the print density.	p.65
Mixed Size Original	Print the data containing pages of the different page sizes.	p.109
Combine	Impose continuous pages onto one sheet.	p.68
Image Repeat	Impose multiple copies of the same original onto one sheet.	p.68
Booklet	Specify the imposition setting when creating a booklet. You can also bi-fold the pages and bind them in the center when the optional multifunction finisher is connected.	p.68
Stamp	Stamp the page number, date, or text in the header or footer.	p.69
Add Cover	Add front and back covers to the printout.	p.77
Separation	Insert slip sheets. When the optional face down finisher, high capacity stacker, or multifunction finisher is connected, the offset output setting is also available.	p.77
Binding Margin	Specify the binding margin.	p.78
Staple / Punch	Specify the stapling position.	
	When using the optional face down finisher	p.184
	When using the optional multifunction finisher	p.214
	Specify the punch position. (When using the optional multifunction finisher with the punch unit)	p.214
Fold*	Configure the paper folding settings. (When using the optional multifunction finisher with the folder unit)	p.215
Slow Printing	Decrease the printing speed. This also reduces the amount of noise produced by the machine when printing jobs.	p.79
Output Tray	Select the output tray for printouts.	
	When using the optional auto-control stacking tray / wide stacking tray	p.194
	When using the optional high capacity stacker	p.201
	When using the optional multifunction finisher	p.217

Setting item	Use this item to:	See
Face Up/Down	Specify whether to stack the pages face up or face down in the stacker.	
	When using the optional auto-control stacking tray / wide stacking tray	p.194
	When using the optional high capacity stacker	p.201
	When using the optional multifunction finisher	p.217
Output Tray Relay	The output tray switches automatically when the tray that is being used becomes full.	
	When using the optional auto-control stacking tray	p.194
	When using the optional high capacity stacker	p.201
	When using the optional multifunction finisher	p.217
Auto Image Rotation	Rotate the image 90 degrees automatically when the orientation of the original and paper do not match.	p.79

* [Mixed Size Z-fold] under [Fold] cannot be configured.

Font List

The fonts you can use are listed below.

PS Fonts

■ European Fonts

AlbertusMT
AlbertusMT-Italic
AlbertusMT-Light
AntiqueOlive-Bold
AntiqueOlive-Compact
AntiqueOlive-Italic
AntiqueOlive-Roman
Apple-Chancery
Arial-BoldItalicMT
Arial-BoldMT
Arial-ItalicMT
ArialMT
AvantGarde-Book
AvantGarde-BookOblique
AvantGarde-Demi
AvantGarde-DemiOblique
Bodoni
Bodoni-Bold
Bodoni-BoldItalic
Bodoni-Italic
Bodoni-Poster
Bodoni-PosterCompressed
Bookman-Demi
Bookman-DemiItalic
Bookman-Light
Bookman-LightItalic
Carta
Chicago
Clarendon
Clarendon-Bold
Clarendon-Light
CooperBlack
CooperBlack-Italic
Copperplate-ThirtyThreeBC
Copperplate-ThirtyTwoBC
Coronet-Regular
Courier
Courier-Bold
Courier-BoldOblique
Courier-Oblique
Eurostile
Eurostile-Bold
Eurostile-BoldExtendedTwo
Eurostile-ExtendedTwo
Geneva

GillSans
GillSans-Bold
GillSans-BoldCondensed
GillSans-BoldItalic
GillSans-Condensed
GillSans-ExtraBold
GillSans-Italic
GillSans-Light
GillSans-LightItalic
Goudy
Goudy-Bold
Goudy-BoldItalic
Goudy-ExtraBold
Goudy-Italic
Helvetica
Helvetica-Bold
Helvetica-BoldOblique
Helvetica-Condensed
Helvetica-Condensed-Bold
Helvetica-Condensed-BoldObli
Helvetica-Condensed-Oblique
Helvetica-Narrow
Helvetica-Narrow-Bold
Helvetica-Narrow-BoldOblique
Helvetica-Narrow-Oblique
Helvetica-Oblique
HoeflerText-Black
HoeflerText-BlackItalic
HoeflerText-Italic
HoeflerText-Ornaments
HoeflerText-Regular
JoannaMT
JoannaMT-Bold
JoannaMT-BoldItalic
JoannaMT-Italic
LetterGothic
LetterGothic-Bold
LetterGothic-BoldSlanted
LetterGothic-Slanted
LubalinGraph-Book
LubalinGraph-BookOblique
LubalinGraph-Demi
LubalinGraph-DemiOblique
Marigold
Monaco
MonaLisa-Recut
NewCenturySchlbk-Bold
NewCenturySchlbk-BoldItalic
NewCenturySchlbk-Italic
NewCenturySchlbk-Roman
NewYork
Optima
Optima-Bold
Optima-BoldItalic
Optima-Italic
Oxford
Palatino-Bold
Palatino-BoldItalic

Palatino-Italic
 Palatino-Roman
 StempelGaramond-Bold
 StempelGaramond-BoldItalic
 StempelGaramond-Italic
 StempelGaramond-Roman
 Symbol
 Tekton
 Times-Bold
 Times-BoldItalic
 Times-Italic
 Times-Roman
 TimesNewRomanPS-BoldItalicMT
 TimesNewRomanPS-BoldMT
 TimesNewRomanPS-ItalicMT
 TimesNewRomanPSMT
 Univers
 Univers-Bold
 Univers-BoldExt
 Univers-BoldExtObl
 Univers-BoldOblique
 Univers-Condensed
 Univers-CondensedBold
 Univers-CondensedBoldOblique
 Univers-CondensedOblique
 Univers-Extended
 Univers-ExtendedObl
 Univers-Light
 Univers-LightOblique
 Univers-Oblique
 Wingdings
 ZapfChancery-MediumItalic
 ZapfDingbats

■ Japanese Fonts

IPA Mincho
 IPA Gothic

■ PCL Fonts

Albertus Extra Bold
 Albertus Medium
 Antique Olive
 Antique Olive Bold
 Antique Olive Italic
 Arial
 Arial Bold
 Arial Bold Italic
 Arial Italic
 AvantGarde-Book
 AvantGarde-BookOblique
 AvantGarde-Demi
 AvantGarde-DemiOblique
 Bookman-Demi
 Bookman-DemiItalic
 Bookman-Light

Bookman-LightItalic
 Calibri
 Calibri Bold
 Calibri Bold Italic
 Calibri Italic
 Cambria
 Cambria Bold
 Cambria Bold Italic
 Cambria Italic
 CG Omega
 CG Omega Bold
 CG Omega Bold Italic
 CG Omega Italic
 CG Times
 CG Times Bold
 CG Times Bold Italic
 CG Times Italic
 Clarendon Condensed Bold
 Coronet
 Courier
 CourierPS
 Courier Bold
 Courier Bold Italic
 Courier Italic
 CourierPS-Bold
 CourierPS-BoldOblique
 CourierPS-Oblique
 Garamond Antiqua
 Garamond Halbfett
 Garamond Kursiv
 Garamond Kursiv Halbfett
 Helvetica
 Helvetica-Bold
 Helvetica-BoldOblique
 Helvetica-Narrow
 Helvetica-Narrow-Bold
 Helvetica-Narrow-BoldOblique
 Helvetica-Narrow-Oblique
 Helvetica-Oblique
 Letter Gothic
 Letter Gothic Bold
 Letter Gothic Italic
 Marigold
 NewCenturySchlbk-Bold
 NewCenturySchlbk-BoldItalic
 NewCenturySchlbk-Italic
 NewCenturySchlbk-Roman
 Palatino-Bold
 Palatino-BoldItalic
 Palatino-Italic
 Palatino-Roman
 Symbol
 Symbol IPS
 Times New Roman
 Times New Roman Bold
 Times New Roman Bold Italic
 Times New Roman Italic
 Times-Bold

Times-BoldItalic
 Times-Italic
 Times-Roman
 Univers Bold
 Univers Bold Italic
 Univers Condensed Bold
 Univers Condensed Bold Italic
 Univers Condensed Medium
 Univers Condensed Medium Italic
 Univers Medium
 Univers Medium Italic
 Wingdings
 ZapfChancery-MediumItalic
 ZapfDingbats

Printing From Your Tablet or Smartphone

You can directly print PDF documents saved on a mobile device such as your tablet or smartphone by using the RISO PRINT-S application. In addition, you can also configure each setting such as duplex printing, imposition, punching, and stapling.



- It is available when the PS kit is installed.
- Make sure that wireless LAN (Wi-Fi) has been connected beforehand. For more information on how to connect or set wireless LAN (Wi-Fi), see the instruction manual for your wireless LAN.
- Available functions vary depending on your printer or optional equipment connected.
- You can not directly open PDF document from RISO PRINT-S. Before enabling RISO PRINT-S, you need to view the PDF document from the other application. For more information, see the help guide for RISO PRINT-S.

Supported OS	iOS ^{*1} , Android
Supported language	Japanese, English, French
Data available for printing	PDF ^{*2} Versions 1.3, 1.4, 1.5, 1.6, 1.7 ^{*3}

*1 Printing from iBooks is not supported.

*2 The encryption PDF is not supported.

*3 Expanded functions are not available.

Installing the Application

Install RISO PRINT-S from App Store or Google Play.

Appendix

This chapter describes how to perform maintenance and replace ink cartridges and includes information about machine specifications and consumables, as well as an index.

Maintenance

p.240

This section explains the functions available on the [Maintenance] menu on the [Home1] screen.

About Ink Cartridges

p.242

This section describes how to replace ink cartridges.

Specifications

p.243

This section describes the basic specifications of the ComColor GL series and optional equipment.

Consumables

p.253

This section describes the specifications of ink cartridges and spare staples.

Index

p.254



Maintenance

The following adjustments can be made in the [Maintenance] menu on the [Home1] screen.

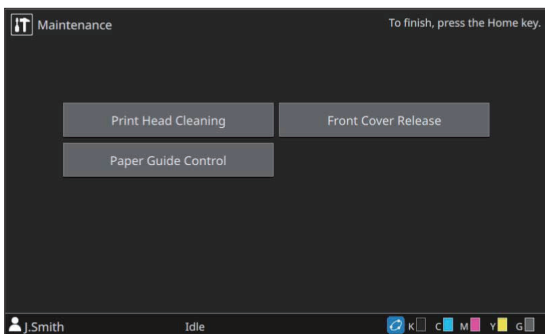

[Print Head Cleaning]

Cleans the ink head.

[Front Cover Release]

Releases the lock of the front cover on the machine.

[Paper Guide Control]

Adjusts the position of the paper guides when using the optional auto-control stacking tray or high capacity stacker.

[Glue Temperature]

Checks the temperature of the glue unit when using the optional Perfect Binder. It is also possible to preheat the glue unit.

For more information, see the user's guide for the Perfect Binder.

[Maximum Pages per Mail]

Specify the maximum number of sheets of paper that can be inserted per mail when using the optional Wrapping Envelope Finisher.

For more information, see the user's guide for the Wrapping Envelope Finisher.

Print Head Cleaning

Clean the ink head when you notice a change in image quality, such as blurring in part of a copy, white streaking, or faded colors.



- By default, the unit is configured to automatically perform cleaning every time a certain number of printouts are made.

[Normal Cleaning]

Cleaning to prevent clogging of the ink heads.

[Strong Cleaning]

Strong cleaning performed when the ink head has clogged.

- 1 Touch [Maintenance] on the [Home1] screen.
- 2 Touch [Print Head Cleaning].
The [Print Head Cleaning] screen is displayed.
- 3 Select the type of head cleaning.
- 4 Touch [OK].

Front Cover Release

Normally, the front cover of the machine is locked. The lock will be released in cases when it is necessary to open the front cover such as when paper has jammed or when ink has become empty. To open the front cover during regular operation, go to the [Maintenance] screen and touch [Front Cover Release]. The lock will be released and you will be able to open the front cover. Once the cover has been closed, the lock will automatically engage as soon as operations start.

Paper Guide Control

Adjusts the position of the paper guides when using the optional auto-control stacking tray or high capacity stacker.

It is also possible to manually perform fine adjustments of the positions of the side guides and end guide.

[Auto]

The position of the paper guides are automatically adjusted to suit the size of paper.

[Narrower]

The positions of the paper guides are narrowed by 1 mm (3/64") each towards the inner side of the stacker.

[Wider]

The positions of the paper guides are expanded by 1 mm (3/64") each towards the outer side of the stacker.



- Normally, use [Auto].
- With the auto-control stacking tray, the guides will expand when the paper guide open button is pressed when such as removing paper. For more information, see "Stacking Tray (Auto-control Stacking Tray / Wide Stacking Tray)" (p.191).

Manual Control of Paper Guide Control

You can expand or narrow the positions of the guides from their positions configured with [Auto]. You can individually adjust the positions of the side guides and end guide.

- 1 Touch [Maintenance] on the [Home1] screen.**
- 2 Touch [Paper Guide Control].**
The [Paper Guide Control] screen is displayed.
- 3 Adjust the position of the paper guides.**
 - To return the adjusted value to 0 mm, touch [Auto].
 - The adjusted value will also return to 0 mm when the [Power] key on the operation panel is pressed to restart the unit, the [Reset] key is pressed, or when the paper size has been changed.
- 4 Touch [Close].**

Glue Temperature

Checks the temperature of the glue unit when using the optional Perfect Binder. It is also possible to preheat the glue unit.

Maximum Pages per Mail

Specify the maximum number of sheets of paper that can be inserted per mail when using the optional Wrapping Envelope Finisher.

About Ink Cartridges

Ink Cartridge Replacement

When ink runs out, the ink replacement message is displayed and printing stops. You cannot print if the message shows that even one color needs to be replaced. Replace the cartridge of the color shown.



- Do not remove the ink cartridge until the ink replacement message is displayed.



- When the remaining amount of ink is low, the remaining ink indicator on the touch panel screen flashes. Prepare a new ink cartridge for the color that flashes.

1 Open the front cover.

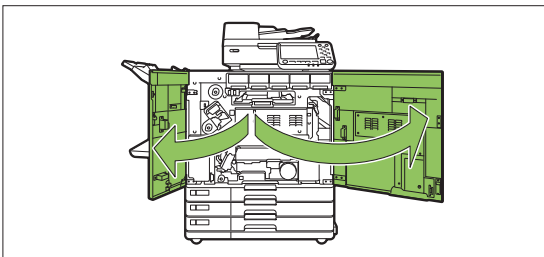

2 Remove the ink cartridge identified as empty.

Confirm the color of the ink cartridge.

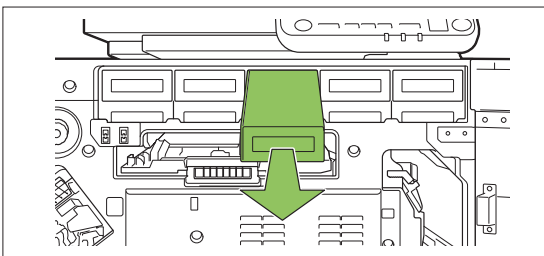

3 Remove the cap from the new ink cartridge.

Affix the removed cap on the old ink cartridge.

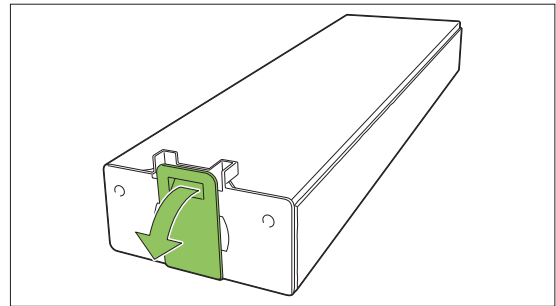

4 Insert the new ink cartridge.

Position the ink cartridge so that the ▲ mark faces upward, and insert it until it stops.

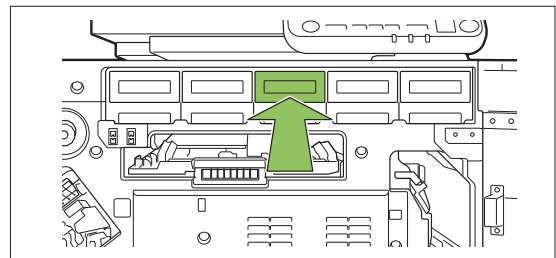

5 Close the front cover.

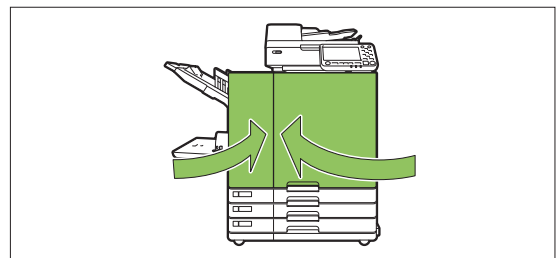

Specifications

■ ComColor GL9730/GL9730R/GL7430/GL7430R Specifications

Basic Functions and Print Functions

Model Name	ComColor GL9730/GL9730R: 68A01 ComColor GL7430/GL7430R: 68A03
Type	Console
Color Support	5 colors (Cyan, Magenta, Yellow, Black, Gray)
Print Type	Line-type inkjet system
Ink Type	Oil-based pigment ink (Cyan, Magenta, Yellow, Black, Gray)
Print Resolution	Standard/High Chromogenic: Black: 600 dpi (main scanning direction) × 600 dpi (sub-scanning direction) Cyan, Magenta, Yellow, Gray: 300 dpi (main scanning direction) × 300 dpi (sub-scanning direction) Fine: Black: 600 dpi (main scanning direction) × 600 dpi (sub-scanning direction) Cyan, Magenta, Yellow, Gray: 300 dpi (main scanning direction) × 600 dpi (sub-scanning direction)
Number of Gray Levels	Black: 4 gray levels Cyan, Magenta, Yellow, Gray: 12 gray levels
Data Processing Resolution	Standard: Black: 600 dpi (main scanning direction) × 600 dpi (sub-scanning direction) Cyan, Magenta, Yellow, Gray: 300 dpi (main scanning direction) × 300 dpi (sub-scanning direction) High-definition: Black: 600 dpi (main scanning direction) × 600 dpi (sub-scanning direction) Cyan, Magenta, Yellow, Gray: 300 dpi (main scanning direction) × 600 dpi (sub-scanning direction) Line Smoothing: 600 dpi (main scanning direction) × 600 dpi (sub-scanning direction)
Warm-up Time	2 min. 30 sec. or less (at room temperature of 23 °C (73.4 °F))
First Print Time ^{*1}	5 sec. or less (A4-LEF) ^{*7}

Continuous Print Speed* ² * ⁶	ComColor GL9730/GL9730R	A4-LEF* ⁷	Simplex: 165 ppm Duplex: 82 sheets/minute
		Letter-LEF	Simplex: 160 ppm Duplex: 80 sheets/minute
		A4	Simplex: 120 ppm Duplex: 60 sheets/minute
		Letter	Simplex: 120 ppm Duplex: 60 sheets/minute
		Legal	Simplex: 104 ppm Duplex: 44 sheets/minute
		JIS-B4	Simplex: 102 ppm Duplex: 44 sheets/minute
		A3	Simplex: 88 ppm Duplex: 42 sheets/minute
		Ledger	Simplex: 86 ppm Duplex: 42 sheets/minute
	ComColor GL7430/GL7430R	A4-LEF* ⁷	Simplex: 140 ppm Duplex: 70 sheets/minute
		Letter-LEF	Simplex: 140 ppm Duplex: 70 sheets/minute
		A4	Simplex: 108 ppm Duplex: 54 sheets/minute
		Letter	Simplex: 108 ppm Duplex: 54 sheets/minute
		Legal	Simplex: 92 ppm Duplex: 42 sheets/minute
		JIS-B4	Simplex: 90 ppm Duplex: 42 sheets/minute
A3		Simplex: 78 ppm Duplex: 38 sheets/minute	
Ledger		Simplex: 76 ppm Duplex: 38 sheets/minute	
Paper Size	Standard Tray	Maximum: 340 mm × 550 mm (13 3/8" × 21 5/8") Minimum: 90 mm × 148 mm (3 9/16" × 5 27/32")	
	Feed Tray	Maximum: 297 mm × 432 mm (11 11/16" × 17") Minimum: 182 mm × 182 mm (7 3/16" × 7 3/16")	
Printable Area		314 mm × 548 mm (12 11/32" × 21 9/16")	
Guaranteed Print Area* ³		Standard: Margin width of 3 mm (1/8") Maximum: Margin width of 1 mm (3/64")	
Paper Weight	Standard Tray	46 g/m ² - 210 g/m ² (12-lb bond - 56-lb bond) (plain paper)	
	Feed Tray	52 g/m ² - 104 g/m ² (14-lb bond - 28-lb bond) (plain paper)	
Paper Tray Capacity	Standard Tray	Height up to 110 mm (4 5/16")	
	Feed Tray	Height up to 56 mm (2 3/16") (3 trays)	
Output Tray Capacity		Height up to 60 mm (2 11/32")	
PDL (Page Description Language)		RISORINC/C IV	
Supported Protocols		TCP/IP, HTTP, HTTPS (TLS), DHCP, ftp, lpr, IPP, SNMP (SNMP v1), Port 9100 (RAW port), IPv4, IPv6, IPSec (IKEv1)	
Network Interface		Ethernet 1000BASE-T/100BASE-TX/10BASE-T (2ch)	
Memory Capacity		4 GB	
Solid State Drive* ⁵	Capacity	512 GB	
	Available Space	Approx. 370 GB	
Operating System		Linux	
Power Source		AC 100 V - 240 V, 50 Hz - 60 Hz, 12.0 A - 6.0 A	

Power Consumption	Max. 1,200 W
	Ready* ⁴ : 110 W or less
	Sleep* ⁸ : 2 W or less
	Stand-by: 0.4 W or less
Operating Noise	Max. 66 dB (A) A4-LEF (Simplex) at the maximum print speed / Plain paper (64 g/m ² (17-lb bond))
A-weighted Sound Power Level* ⁹	Max. 75 dB A4-LEF (Simplex) Monochrome/Color: 160 ppm
Operating Environment	Temperature: 15 °C - 30 °C (59 °F - 86 °F) Humidity: 40% - 70% RH (non-condensing)
Dimensions (W × D × H)	In use: 1,220 mm × 725 mm × 1,160 mm (48 1/32" × 28 17/32" × 45 21/32") With cover and tray closed: 1,160 mm × 705 mm × 1,015 mm (45 21/32" × 27 3/4" × 39 15/16")
Weight	Approx. 177kg (390 lb)
Safety Information	Indoor type, pollution degree 2*, At altitudes of 2,000 m or lower * The pollution degree of the usage environment due to dirt and dust in the air. Degree "2" corresponds to a general indoor environment.
Dimensions When Operating (W × D × H)	With the front cover open and the operation panel in the upright position: 1,220 mm × 1,240 mm × 1,160 mm (48 1/32" × 48 13/16" × 45 21/32")

*1 Within 10 minutes after the last print job

*2 When using plain paper and recycled paper (85 g/m² (23-lb bond)), and standard density setting
Chart used: Print measurement pattern [Color measurement sample 2 (JEITA standard pattern J6)]

*3 The guaranteed area when printing images is the area enclosed within 3 mm (1/8") of the edges of the paper.
The margin when printing envelopes is 10 mm (13/32").

*4 Without printing and temperature adjustment operation

*5 One gigabyte (GB) is calculated as 1,073,741,824 bytes.

*6 The continuous print speed varies depending on the type of optional output equipment connected.

When using the face down finisher (A4-LEF Simplex)

Without offset:

165 sheets/minute (ComColor GL9730/GL9730R)

140 sheets/minute (ComColor GL7430/GL7430R)

With offset:

125 sheets/minute (ComColor GL9730/GL9730R)

115 sheets/minute (ComColor GL7430/GL7430R)

When using the high capacity stacker (A4-LEF Simplex)

Without offset:

165 sheets/minute (ComColor GL9730/GL9730R)

140 sheets/minute (ComColor GL7430/GL7430R)

With offset:

110 sheets/minute (ComColor GL9730/GL9730R)

95 sheets/minute (ComColor GL7430/GL7430R)

*7 LEF stands for "Long edge feed".

*8 When setting [Power Consumption (in Sleep)] to [Low]

*9 When using plain paper (62 g/m² (17-lb bond))

■ Scanner HS7000 (Optional)

Copy Functions and Scan Functions

Type	Flat Bed Scanner With Automatic Document Feeder (ADF)	
Scanning Modes	Copy mode: Color, Monochrome, Auto, Cyan, Magenta Scan mode: Color, Monochrome, Auto, Grayscale	
Scanning Resolution	600 dpi, 400 dpi, 300 dpi, or 200 dpi	
Maximum Scanning Area	303 mm × 432 mm (11 15/16" × 17") (when using platen glass) 295 mm × 430 mm (11 5/8" × 16 15/16") (when using ADF)	
Copy Functions	Writing Resolution	Standard: 300 dpi × 300 dpi (Black only: 600 dpi × 600 dpi) Fine: 300 dpi × 600 dpi (Black only: 600 dpi × 600 dpi)
	Copy Paper Size	Maximum: 303 mm × 432 mm (11 15/16" × 17") (equivalent to A3)
	First Copy Time	Monochrome/Color: 7 sec. or less (when copying A4-LEF/Letter-LEF orientation using Color Priority Mode)
	Copying Speed	Simplex copying (A4-LEF/Letter-LEF, using ADF): 80 ppm or higher Duplex copying (A4-LEF/Letter-LEF, using ADF): 80 ppm or higher
	Reproduction Size	50% - 200% (Copy mode) 50% - 200% (Scanner mode, resolution: 200/300 dpi) only 100% (Scanner mode, resolution: 400/600 dpi)
ADF	Type	Original source displacement (capable of scanning both sides of a document by simultaneous duplex scanning)
	Original Size	Maximum: 297 mm × 432 mm (11 11/16" × 17") (equivalent to A3) Minimum: 100 mm × 148 mm (3 15/16" × 5 27/32")
	Paper Weight	52 g/m ² - 128 g/m ² (14-lb bond - 34-lb bond)
	Original Capacity	Max. 200 sheets: 80 g/m ² (21-lb bond) Height up to 25 mm (1")
Scan Functions	Scanning Gray Levels	10-bit input and 8-bit output for each RGB color
	Scanning Speed	Monochrome/Color: 100 ppm * RISO KAGAKU standard original (A4-LEF/Letter-LEF), 300 dpi, JPEG, PDF, when stored to main unit solid state drive.
	Network Interface* ¹	Ethernet 1000BASE-T/100BASE-TX/10BASE-T
	Data-saving Method* ¹	Save to main unit solid state drive, server, or USB flash drive, or send by e-mail
	Data-saving Format* ¹	Monochrome: TIFF, PDF, PDF/A Grayscale/Full Color: TIFF, JPEG, PDF, PDF/A
Power Source	AC 100 V - 240 V, 1.2 A - 0.6 A, 50 Hz - 60 Hz	
Power Consumption	Max. 100 W	
Dimensions (W × D × H)	640 mm × 560 mm × 255 mm (25 7/32" × 22 1/16" × 10 1/16")	
Weight	Approx. 25 kg (55 lb)	
Safety Information	Indoor type, pollution degree 2*, At altitudes of 2,000 m or lower * The pollution degree of the usage environment due to dirt and dust in the air. Degree "2" corresponds to a general indoor environment.	

Dimensions When Operating (when connected to main unit) (W × D × H)	In use: 1,235 mm × 825 mm × 1,260 mm (48 19/32" × 32 15/32" × 49 19/32") With the front cover open and the operation panel in the upright position: 1,235 mm × 1,345 mm × 1,635 mm (48 19/32" × 52 15/16" × 64 11/32")
---	---

*1 Via the internal host controller

■ Face Down Finisher G10 (Optional)

Type	1-Shift Output Tray System With Staple Function
Finishing Functions	Offset output, staple
Paper Size	Without offset Maximum: 340 mm × 550 mm (13 3/8" × 21 5/8") Minimum: 90 mm × 148 mm (3 9/16" × 5 27/32")
	Offset output Regular-sized paper width: 182 mm × 257 mm - 297 mm × 431.8 mm (7 3/16" × 10 1/8" - 11 11/16" × 17") Irregular-sized paper width: 131 mm × 148 mm - 305 mm × 550 mm (5 3/16" × 5 27/32" - 12" × 21 5/8")
Paper Weight	46 g/m ² - 210 g/m ² (12-lb bond - 56-lb bond)
Tray Capacity	Height up to 108 mm (4 1/4")
Maximum Number of Staples	50 sheets* : A4, A4-LEF, JIS-B5, JIS-B5-LEF, Letter, Letter-LEF, 16K, 16K-LEF 25 sheets* : A3, JIS-B4, Ledger, Legal, Foolscap, 8K * When using plain paper and recycled paper (85 g/m ² (23-lb bond))
Paper Size for Staple	A3, JIS-B4, A4, A4-LEF, JIS-B5, JIS-B5-LEF, Ledger, Legal, Letter, Letter-LEF, Foolscap, 8K, 16K, 16K-LEF
Paper Weight for Staple	52 g/m ² - 210 g/m ² (14-lb bond - 56-lb bond) (plain paper, recycled paper)
Staple Position	1 at front side (angle stapling) 1 at rear side (angle stapling) 2 at center (parallel stapling)
Power Source	AC 100 V - 240 V, 1.2 A - 0.6 A, 50 Hz - 60 Hz
Power Consumption	Max. 110W
Dimensions (W × D × H)	760 mm × 680 mm × 585 mm (29 29/32" × 26 25/32" × 23 1/32")
Weight	Approx. 30 kg (66 lb)
Safety Information	Indoor type, pollution degree 2*, At altitudes of 2,000 m or lower * The pollution degree of the usage environment due to dirt and dust in the air. Degree "2" corresponds to a general indoor environment.
Dimensions When Operating (when connected to main unit) (W × D × H)	In use: 1,440 mm × 725 mm × 1,345 mm (56 11/16" × 28 17/32" × 52 15/16") With cover open: 1,440 mm × 1,240 mm × 1,345 mm (56 11/16" × 48 13/16" × 52 15/16")

■ High Capacity Feeder G10 (Optional)

Type	External High Capacity Feeder
Paper Size	Maximum: 340 mm × 465 mm (13 3/8" × 18 5/16") Minimum: 90 mm × 148 mm (3 9/16" × 5 27/32")
Paper Type and Weight	46 g/m ² - 210 g/m ² (12-lb bond - 56-lb bond) (plain paper, recycled paper, envelopes, postcards)
Tray Capacity	Height up to 440 mm (17 11/32")
Power Source	AC 100 V - 240 V, 1.0 A - 0.5 A, 50 Hz - 60 Hz
Power Consumption	Max. 100 W
	Ready ^{*1} : 30 W or less
	Sleep ^{*2} : 30 W or less
	Stand-by: 0.5 W or less
Operating Noise	Max. 68 dB (A) A4-LEF (Simplex) at the maximum print speed
Dimensions (W × D × H)	790 mm × 630 mm × 740 mm (31 1/8" × 24 13/16" × 29 5/32")
Weight	Approx. 69 kg (152 lb)
Safety Information	Indoor type, pollution degree 2*, At altitudes of 2,000 m or lower * The pollution degree of the usage environment due to dirt and dust in the air. Degree "2" corresponds to a general indoor environment.
Dimensions When Operating (when connected to main unit) (W × D × H)	In use: 1,565 mm × 725 mm × 1,160 mm (61 19/32" × 28 17/32" × 45 21/32") With the cover open: 1,565 mm × 1,240 mm × 1,160 mm (61 19/32" × 48 13/16" × 45 21/32")

*1 Without printing operation

*2 When setting [Power Consumption (in Sleep)] to [Low]

■ High Capacity Stacker G10 (Optional)

Type	High Capacity Stacker With Offset Function
Finishing Functions	Collating, stacking (offset)
Paper Size	Maximum: 340 mm × 460 mm (13 3/8" × 18 1/8") Minimum: 90 mm × 148 mm (3 9/16" × 5 27/32") Offset: 90 mm × 182 mm - 340 mm × 432 mm (3 9/16" × 7 3/16" - 13 3/8" × 17") (Envelopes are not acceptable.)
Paper Type and Weight	46 g/m ² - 210 g/m ² (12-lb bond - 56-lb bond) (plain paper, recycled paper, postcards)
Tray Capacity	Collating: Height up to 440 mm (17 11/32") ^{*1} Offset: Height up to 405 mm (15 15/16") ^{*2}
Power Source	AC 100 V - 240 V, 1.4 A - 0.7 A, 50 Hz - 60 Hz
Power Consumption	Max. 140 W
	Ready ^{*3} : 30 W or less
	Sleep ^{*4} : 30 W or less
	Stand-by: 0.5 W or less
Operating Noise	Max. 68 dB (A) A4-LEF (Simplex) at the maximum print speed

Dimensions (W × D × H)	1,000 mm × 700 mm × 960 mm (39 3/8" × 27 9/16" × 37 13/16")
Weight	Approx. 135 kg (298 lb)
Safety Information	Indoor type, pollution degree 2*, At altitudes of 2,000 m or lower * The pollution degree of the usage environment due to dirt and dust in the air. Degree "2" corresponds to a general indoor environment.
Dimensions When Operating (when connected to main unit) (W × D × H)	In use: 2,200 mm × 725 mm × 1,160 mm (86 19/32" × 28 17/32" × 45 21/32") With the cover open: 2,210 mm × 1,315 mm × 1,160 mm (87" × 51 3/4" × 45 21/32")

*1 Height up to 110 mm (4 5/16") for A5, postcards, envelopes, non-regular size paper

*2 Not applicable to A5, postcards, envelopes, non-regular size paper, etc.

*3 Without printing operation

*4 When setting [Power Consumption (in Sleep)] to [Low]

■ Multifunction Finisher FG20 (Optional)

Type	External Paper Finishing Unit	
Tray Type	Top tray, stacking tray, booklet tray	
Finishing Functions	Offset output, staple, punch, booklet binding, bi-fold	
Usable Paper Size of Fold	Top Tray	Maximum: 330 mm × 488 mm (13" × 19 3/16") Minimum: 100 mm × 148 mm (3 15/16" × 5 27/32")
	Stacking Tray	Maximum: 330 mm × 488 mm (13" × 19 3/16") Minimum: 148 mm × 148 mm (5 27/32" × 5 27/32")
	Stapling	Maximum: 297 mm × 432 mm (11 11/16" × 17") (equivalent to A3) Minimum: 182 mm × 148 mm (7 3/16" × 5 27/32")
	Booklet Tray	Maximum: 330 mm × 488 mm (13" × 19 3/16") Minimum: 182 mm × 257 mm (7 3/16" × 10 1/8")
Paper Weight	Top Tray	52 g/m ² - 210 g/m ² (14-lb bond - 56-lb bond)
	Stacking Tray	52 g/m ² - 210 g/m ² (14-lb bond - 56-lb bond)
	Booklet Tray	60 g/m ² - 90 g/m ² (16-lb bond - 24-lb bond) (Paper weight for cover pages: 90 g/m ² - 210 g/m ² (24-lb bond - 56-lb bond))
Tray Capacity	Top Tray ^{*2}	Height up to 50 mm (1 31/32")
	Stacking Tray	Height up to 200 mm (7 7/8")
	Booklet Tray	Height up to 50 mm (1 31/32")
Output Speed	Maximum Output Speed	165 sheets/minute ^{*6} (ComColor GL9730/GL9730R) 140 sheets/minute ^{*6} (ComColor GL7430/GL7430R)
	Stapling Output	80 sheets/minute ^{*7} (ComColor GL9730/GL9730R) 70 sheets/minute ^{*7} (ComColor GL7430/GL7430R)
	Offset Output	80 sheets/minute ^{*7} (ComColor GL9730/GL9730R) 70 sheets/minute ^{*7} (ComColor GL7430/GL7430R)
	Booklet Output	2 books/minute ^{*8}

Stapling	Maximum Number of Staples	100 sheets ^{*2 *3}
	Usable Paper Size	Maximum: 297 mm × 432 mm (11 11/16" × 17") (equivalent to A3) Minimum: 182 mm × 148 mm (7 3/16" × 5 27/32")
	Paper Weight	52 g/m ² - 210 g/m ² (14-lb bond - 56-lb bond)
	Staple Position	1 at front side (angle stapling/parallel stapling) 1 at rear side (angle stapling ^{*4} , parallel stapling) 2 at center (parallel stapling)
Punching ^{*9}	Number of Punches	2 holes, 3 holes 2 holes, 4 holes
	Paper Size	2 holes: A3, JIS-B4, A4-LEF, A4, JIS-B5-LEF, Ledger, Legal, Letter, Letter-LEF, Foolscap, 8K, 16K-LEF 3 holes: A3, JIS-B4, A4-LEF, JIS-B5-LEF, Ledger, Letter-LEF, 8K, 16K-LEF 4 holes: A3, A4-LEF, Ledger, Letter-LEF, 8K, 16K-LEF
	Paper Weight	52 g/m ² - 210 g/m ² (14-lb bond - 56-lb bond)
Creating a Booklet (Center margin/2-fold)	Maximum Number of Sheets ^{*2 *5}	Center margin: 20 sheets (80 pages) 2-fold: 5 sheets (20 pages)
Dimensions (W × D × H) ^{*1}		1,205 mm × 735 mm × 1,215 mm (47 7/16" × 28 15/16" × 47 27/32")
Weight ^{*1 *10}		Approx. 140 kg (308 lb)
Power Source		AC 100 V - 240 V, 50 Hz - 60 Hz, 2.3 A - 1.1 A ^{*11}
Power Consumption ^{*12}		Max. 230W
Operating Noise		68 dB (A) or less (when using multifunction finisher)
Safety Information		Indoor type, pollution degree 2 [*] , At altitudes of 2,000 m or lower * The pollution degree of the usage environment due to dirt and dust in the air. Degree "2" corresponds to a general indoor environment.
Dimensions (when connected to main unit) (W × D × H)	With folder unit	In use: 2,655 mm x 735 mm x 1,215 mm (104 17/32" × 28 15/16" × 47 27/32")
		With cover, and tray extended: 2,655 mm x 1,325 mm x 1,215 mm (104 17/32" × 52 5/32" × 47 27/32")
	Without folder unit	In use: 2,415 mm x 735 mm x 1,215 mm (95 3/32" × 28 15/16" × 47 27/32")
		With cover, and tray extended: 2,415 mm x 1,325 mm x 1,215 mm (95 3/32" × 52 5/32" × 47 27/32")

*1 Includes the transfer unit.

*2 When using plain paper and recycled paper (85 g/m² (23-lb bond))

*3 65 sheets for a paper size exceeding A4/Letter or for a paper both the width and length of which exceed 216 mm (8 1/2")

*4 Rear-side angle stapling is only available for A4-LEF and A3.

*5 Includes an added cover.

*6 A4-LEF Simplex

*7 A4-LEF Duplex, a 20-page document

*8 A4-SEF, a 60-page document (15 sheets)

*9 To use the punch function, the optional punch unit is required.

*10 Excludes the punch unit.

*11 3.0-1.5 A when connecting to the folder unit (the folder unit: 0.7-0.4 A)

*12 300 W when connecting to the folder unit (the folder unit: 70 W)

■ Folder Unit FG20 (Optional Unit for Multifunction Finisher FG20)

Usable Paper Size and Paper Weight of Fold	Z-fold* ¹	Paper size: A3, JIS-B4, Ledger, 8K Paper weight: 60 g/m ² - 90 g/m ² (16-lb bond - 24-lb bond) (plain paper, recycled paper)
	Tri-fold (Outer Tri-fold/Inner Tri-fold)	Paper size: A4, Letter Paper weight: 60 g/m ² - 90 g/m ² (16-lb bond - 24-lb bond) (plain paper, recycled paper)
Tri-fold Output Tray Capacity* ²		Approx. 30 sheets
Applicable Number of Fold		1 sheet
Dimensions (W × D × H)		235 mm × 735 mm × 1,005 mm (9 1/4" × 28 15/16" × 39 9/16")
Weight		Approx. 52 kg (114 lb)

*1 When printouts are output to the stacking tray, maximum height up pages differ according to the paper size. (A3 paper: 80 pages, JIS-B4 paper: 60 pages)

*2 When using plain paper and recycled paper (85 g/m² (23-lb bond))

■ Additional 2000 Sheet Feeder FG20 (Optional)

Type	External Paper Tray Unit
Usable Paper Size	A4-LEF, JIS-B5-LEF, Letter-LEF, 16K-LEF
Paper Weight	52 g/m ² - 104 g/m ² (14-lb bond - 28-lb bond) (plain paper, recycled paper)
Tray Capacity	Height up to 220 mm (8 21/32")* ¹
Power Source	Power supplied from the main unit
Dimensions (W × D × H)	415 mm × 600 mm × 390 mm (16 11/32" × 23 5/8" × 15 11/32")
Weight	Approx. 29 kg (64 lb)
Safety Information	Indoor type, pollution degree 2*, At altitudes of 2,000 m or lower * The pollution degree of the usage environment due to dirt and dust in the air. Degree "2" corresponds to a general indoor environment.
Dimensions When Operating (when Connected to main unit) (W × D × H)	In use: 1,220 mm × 725 mm × 1,160 mm (48 1/32" × 28 17/32" × 45 21/32") With paper guide, and tray extended: 1,480 mm × 1,240 mm × 1,160 mm (58 9/32" × 48 13/16" × 45 21/32")

*1 When using IJ paper (85 g/m² (23-lb bond))

■ IC Card Authentication Kit II (Optional)

Applicable Card	ISO 14443 TypeA/TypeB/FeliCa®/MIFARE®
Type	RFID system
Power Source	Power supplied from the USB port
Safety Information	Indoor type, pollution degree 2*, At altitudes of 2,000 m or lower * The pollution degree of the usage environment due to dirt and dust in the air. Degree "2" corresponds to a general indoor environment.

■ PS Kit FG10 (Optional)

PS Kit FG10 is not supported in some regions.

Compatible Printers	ComColor GL series
Type	RIP option
PDL (Page Description Language)	PostScript® Level3 (CPSI:3019)* ¹ PDF (1.7) PCL 5c, PCL 6 (PCL XL)* ² TIFF (6.0)* ³
Supported Protocols	TCP/IP, HTTP, HTTPs (TLS), DHCP, ftp, lpr, IPP, SNMP (SNMP v1), Port 9100 (RAW port), IPv4, IPv6, IPsec (IKEv1)
Installed Fonts	PS: 136 Roman fonts and 2 Japanese fonts PCL: 88 Roman fonts

*1 Genuine Adobe engine

*2 RISO shall not provide any PCL printer driver. For PCL output, available functions differ from printing via PS printer driver. When you need the functions not available for PCL output, print via PS printer driver.

*3 For TIFF output, available functions differ from printing via PS printer driver.

Consumables

It is recommended that you use the consumable products listed below.
Consumable specifications and types are subject to change without notice.
For pricing information, please contact your dealer or authorized service representative.

Ink Cartridges

Type	Color	Quantity	Unit
ComColor GL Ink Cartridge (UA)	Cyan Magenta Yellow Gray Black	NET. 1,000 ml	1 piece
ComColor GL Ink Cartridge (E)			
ComColor GL Ink Cartridge (RS)			
ComColor GL Ink Cartridge R (UA)			
ComColor GL Ink Cartridge R (E)			

Use the ink cartridge within approximately 24 months from the date of manufacture (when preserved under room temperature).

For optimal printing quality, we recommend that you use the ink cartridge as soon as possible after purchase. You can find the date of manufacture on the ink cartridge.

Index

A

Add cover	77, 119
Adding a folder	141
Adding a folder to storage	141
Adding a large amount of paper	190
Adding the paper in the standard tray	48
Adding to favorites	82, 107
Adding to the address book	96
Additional copy	81
Additional tray	185
Address/destination	86
ADF	29
ADF original guide	29
ADF original output tray	29
ADF original unit lever	29
ADF scan & pause	65
Admin menu button	32
Admin menu screen	40
Advanced tab	124
Auto image rotation	79, 216
Auto-control stacking tray	191

B

Barcode	122
Barcode area definition	122
Base color level	72, 93
Basic tab	108
Between jobs	119
Between sorts	119
Bi-fold	208, 216
Binding	118, 213
Binding edge	77, 118, 182, 184, 207, 209, 215
Binding margin	77, 78, 184, 215
Black	61, 91, 108
Blank page detection	126
Book shadow erasure	66, 92
Booklet	68, 114
Booklet binding	210, 226
Booklet cover	211
Booklet tray	202
Button operations of the RISO Console	158

C

Canceling copying	57
Card-IJ	111

Carriage	195
Center margin	211, 213
Change setting screen	36
Change setting screen in [USB] - [Load]	39
Change the paper tray setting	62
Changing settings during copying	58
Changing settings during printing	101
Changing the login password	45, 161
Check setting	82, 95
Checking the charge count	160
Checking the current status of a job	52
Checking the detailed count	160
Chroma	122
Clear key	31
Clearing Defaults	83
Collated	64, 109
Color mode	61, 90, 108
Color profile	111, 227
Combine	68, 113
Common buttons	107
Consumables	253
Consumables screen	41, 159
Contrast	122
Copies	108
Copy screen	34
Copying documents saved on a USB flash drive to a folder	153
Copying documents saved on storage to a folder	143
Copying documents saved on storage to a USB flash drive	142
Corrugators	195, 196
Custom menu	82, 96
Custom paper entry	128
Cyan	61, 108

D

Data LED	30
Date stamp	70, 116
Date/time	32
Dedicated carriage	198
Deleting an address or a destination	97
Destination	111
Document name	90
Dot process	122
Double-feed check	62
Downloading scanned jobs to a computer	162

Draft	121
Duplex/simplex	64, 89, 108

E

Edit favorites	112
Editing button order	84
Editing favorites	82
Editing the address book	96
Entering text	43
Envelope guide	187
Envelope guide angle adjustment lever	187
Envelope guide paper feed pressure adjustment lever	187
Envelope imaging	124
Envelopes	24
Environment tab	127
Error diffusion	122
Error LED	30
Ethernet shielded cable	17
External system link	132
External system link screen	40

F

Face down finisher	178
Face down finisher socket	178
Face down tray	28
Face up/down	194, 201, 217
Favorites	81, 151
Favorites tab	112
Feed trays	29
File format	91
File format for saving the scanned data	91
Finished screen	53, 165
Fold	208, 215
Fold direction	209
Folder entry	130
Folder unit	202
FORCEJET™ link icon	32
Form data screen	232
Form overlay	228
Front cover	29, 187
Front cover release	29, 41
Full color	61, 91, 108
Function keys	30

G

Gamma correction	72, 93, 122, 227
Get printer info	130
Grayscale	91

H

Halftone	122
Head cleaning	166
High capacity feeder	187
High capacity feeder socket	187
High capacity stacker	195
High capacity stacker socket	195
High-quality	111
Home key	30
Home1 screen	32
Home2 screen	33

I

IJ paper	111
Image control	72, 93
Image position	73, 117
Image quality	71, 121
Image repeat	68, 114
Image shift	226
Image tab	120
Ink cartridges	242, 253
Inner tri-fold	208, 216
Installing and uninstalling the printer driver	50
Installing the barcode area definition software	168
Interrupt copy	80
Interrupt key	30
IP address	159

J

Jam release cover	178
Job comment	125
Job icon	52
Job list	52
Job name	125
Job status key	30

L

Layout tab	113
Left cover	29, 195
Left to right	114
License info screen	42, 161
Lightness	122
Line smoothing	121
List	112
Load screen	164
Loading orientation of the paper	182, 207
Loading the next copy job	57
Loading the paper	46
Logging into the RISO Console	157
Login	45

Login/logout key30

M

MAC address159
 Machine info screen41
 Magenta61, 108
 Main power LED30
 Main power switch29
 Main unit28
 Main unit socket29
 Maintenance button32
 Maintenance menu screen166
 Maintenance screen41
 Matt coated111
 Max. capacity22
 Maximum load24
 Maximum print area23
 Mixed size original65, 92, 109
 Mixed size Z-fold216
 Mode buttons32
 Multifunction finisher202
 Multi-part paper printing127

N

Numeric keys31

O

Offline icon32
 Offset output183, 183, 183, 212, 214, 214
 Offset output (program)183, 200, 212
 Online/offline131
 Operation panel29, 30
 Operations169
 Orientation109
 Original cover28
 Original orientation64, 89, 184, 215
 Original size22, 109
 Original type22, 71, 93, 120
 Original weight22
 Originals22
 Outer tri-fold208, 216
 Output111
 Output tray193, 194, 200, 201, 212, 217
 Output tray relay193, 194, 200, 201, 212, 217
 Output tray selection194
 Overlay73
 Owner124

P

Page border71

Page split67, 93
 Page stamp69, 116
 Paper arrangers191
 Paper feed guide levers29, 187
 Paper feed pressure adjustment lever28, 187
 Paper guide195
 Paper guide (end)191
 Paper guide (side)191
 Paper guide control194
 Paper guides open button191
 Paper jam indication LED202
 Paper selection61
 Paper size24, 92, 110
 Paper tray110
 Paper tray relay79
 Paper type24, 61, 63, 111
 Paper weight24
 Performing maintenance during copying58
 PIN code89, 125
 Plain paper24
 Platen glass28
 Poster115
 Power key31
 Power-saving features44
 Precautions about originals22
 Preview before saving140
 Preview before sending95
 Print and pause109
 Print density65, 121
 Print head cleaning41
 Print menu screen163
 Print screen35
 Printable area of envelopes23
 Printer configuration128
 Printer driver screen103
 Printing barcode originals175
 Printing on envelopes47
 Printing paper24, 24
 Processing speed priority121
 Program74, 125
 PS kit218
 Punch208, 214

R

Recycled paper24
 Remaining amount of ink32
 Removing printouts196
 Reproduction size61, 94
 Reset key30
 Resolution92
 Restore default107

Restore user settings	107
Reverse order	232
Right cover	195, 202
Right to left	114
Rotation	117

S

Sample copy	81
Save as a file	111
Save document	140, 151
Save document screen in [Storage] - [Save]	37
Save document screen in [USB] - [Save]	38
Save to USB drive	111
Saving as default	83
Scan job build	80, 94
Scan menu screen	162
Scan screen	34
Scanner	28
Scanner LED	28
Scanning level	65, 92
Scanning size	63, 91
Screening	122
Search	142
Search documents saved on storage	142
Separating books	210, 213, 226
Separation	77
Setting a large amount of paper	190
Settings in [Storage] - [Load]	139
Settings in [Storage] - [Save]	137
Settings in [USB] - [Load]	150, 234
Slip sheet	75, 119
Slow printing	79, 126
SNMP community name	127
Sort	64, 109
Specifying a custom paper size	110
Specifying a custom size	109
SSD usage indicator	37
Stacking tray	195, 202
Stacking tray descent button	195
Stacking tray setting position	178
Stamp	69, 116
Standard tray	28
Standard tray descent button	28, 187
Standard tray padding covers	187, 189
Standard tray paper guide	28, 187
Staple	180, 184, 206, 214
Staple function and loading orientation of the paper	182, 207
Start key	30
Starting the RISO Console	157
Stop key	30

Stopper	46
Storage	111
Storage screen	36
Switching the paper in the standard tray	48
System info button	32
System info screen	41, 159

T

Text stamp	70, 117
Top side left	64
Top side up	64
Top tray	202
Top/bottom	114
Touch panel	30, 42
Transfer cover	187, 202
Transfer unit	202
Tray selection per page	225
Tri-fold output tray	202
Tri-fold output tray button	202

U

Uncollated	64, 109
Unusable paper	25
USB port	29
USB screen	38
User info screen	41, 161
User name	32

V

Version	127
Via shared printer	127
View balance	42
View screen in [Storage] - [Load]	37
View screen in [Storage] - [Save]	36
View screen in [USB] - [Load]	39

W

Waiting job list screen	35
Wake on LAN	128
Wake up key	31
Watermark	115
Wide stacking tray	191

Z

Z-fold	208, 216
Zoom	110

Notice for European Union Member States

RISO, the environment and the Waste Electrical and Electronic Equipment Directive "WEEE Directive"

What is the WEEE Directive?

The purpose of the WEEE Directive is to reduce waste and ensure Electrical and Electronic Equipment is recycled at the end of its useful life.



What does the crossed out wheeled bin symbol mean?

The crossed out wheeled bin symbol indicates this product must be disposed of separately to normal waste. Please contact your RISO service agent for information about disposal.

What does the solid bar symbol mean?

The solid bar under the crossed out wheeled bin indicates this product was put on the market after the 13th August 2005.

Who should I contact if I want more information about the WEEE Directive?

You should contact your local RISO service agent for more information.

Notice for Republic of India

RISO complies with the e-waste (Management and Handling) Rules "e-waste Rules".

What is the "e-waste Rules"?

The purpose of the "e-waste Rule" is to reduce waste and ensure Electrical Equipment is recycled at the end of life.

RISO declares our products comply with the "India E-waste Rule" and prohibits use of lead, mercury, hexavalent chromium, polybrominated biphenyls or polybrominated diphenyl ethers at or over a concentration of 0.1% by weight or at or over 0.01% by weight for cadmium, except for the exemptions set in Schedule 2 of the Rule.

You can't dispose of our used products as household waste. Used products contain many hazardous substances which may have a serious, detrimental effect on the environment and/or human health.

What does the crossed out wheeled bin symbol mean?

The crossed wheeled bin symbol indicates this product must be disposed of separately to household waste.



"e-waste Rules" shall apply to products including their components, consumables, parts and spares needed to function properly.

Who should I contact if I want more information about the "e-waste Rules"?

You should contact Riso India Pvt.Ltd.

Email: product-recycling@risoindia.com ; Tel : 0120-4721300



Please contact the following for supplies and service: